

Corso



SOFÁS
SOFAS | SOFÁS

ponto**vírgula**



Corso

SOFÁS
SOFAS | SOFÁS

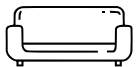

Corso

SOFÁS
SOFAS | SOFÁS

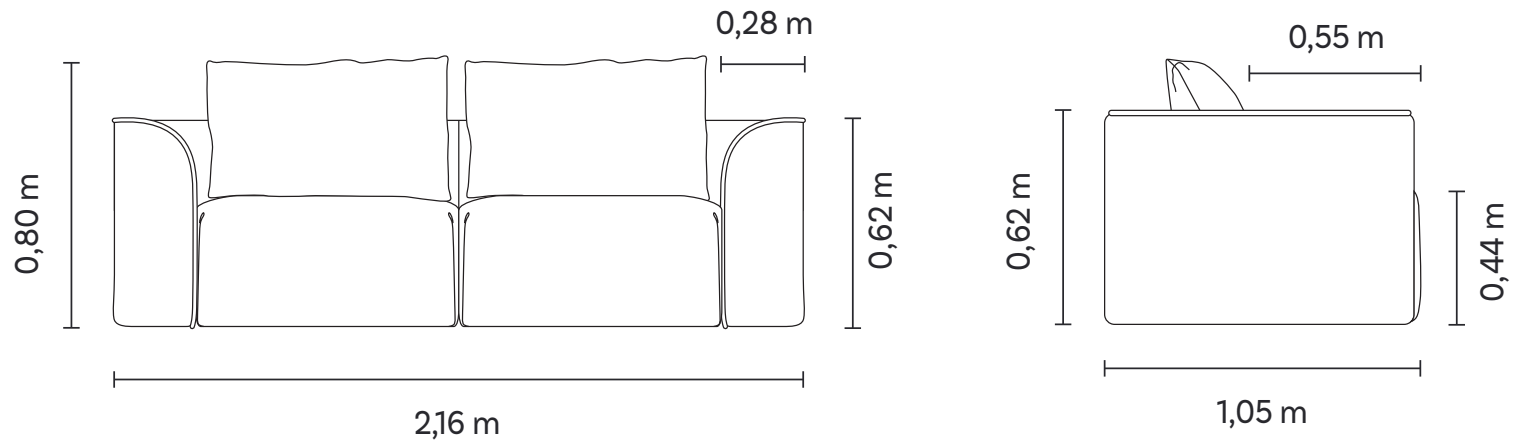

Assento fixo com sobras de tecido e sem detalhe de costura. Encosto e braço fixos, com sobras de tecido na área interna e com costura em debrum composê. Almofada de encosto solta, sem detalhe de costura. Pés em polipropileno injetado na cor preta.

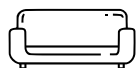

Corso

SOFÁS
SOFÁS | SOFÁS

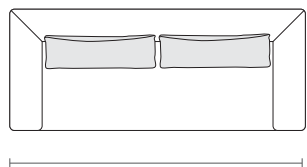

2B1	ASS	ENC
2,16 m	2	2
2,36 m	2	2
2,56 m	2	2
2,76 m	2	2
2,96 m	2	2
3,16 m	2	2

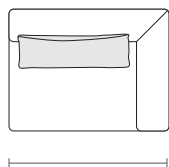

1B1 (D/E)	ASS	ENC
1,08 m	1	1
1,18 m	1	1
1,28 m	1	1
1,38 m	1	1
1,48 m	1	1
1,58 m	1	1

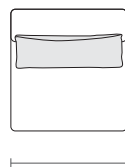

SB1	ASS	ENC
0,80 m	1	1
0,90 m	1	1
1,00 m	1	1
1,10 m	1	1
1,20 m	1	1
1,30 m	1	1

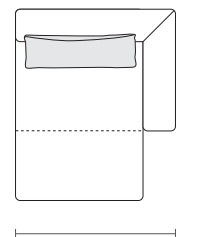

CH 1B (D/E)	ASS	ENC
1,08 X 1,65 m	1	1
1,18 X 1,65 m	1	1
1,28 X 1,65 m	1	1
1,38 X 1,65 m	1	1
1,48 X 1,65 m	1	1
1,58 X 1,65 m	1	1

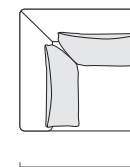

CTO (D/E)	ASS	ENC
1,05 x 1,05 m	1	2

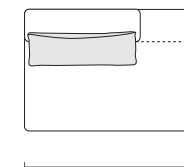

SBBI (D/E)	ASS	ENC
1,30 m	1	1
1,40 m	1	1
1,50 m	1	1
1,60 m	1	1
1,70 m	1	1
1,80 m	1	1

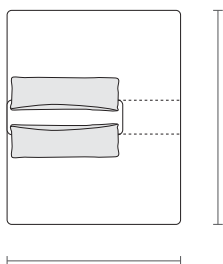

SBBI / SBBI (D/E)	ASS	ENC
1,30 x 1,85 m	2	2
1,40 x 1,85 m	2	2
1,50 x 1,85 m	2	2
1,60 x 1,85 m	2	2
1,70 x 1,85 m	2	2
1,80 x 1,85 m	2	2

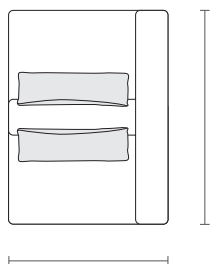

1B 1AS / 1B 1AS	ASS	ENC
1,08 x 1,85 m	2	2
1,18 x 1,85 m	2	2
1,28 x 1,85 m	2	2
1,38 x 1,85 m	2	2
1,48 x 1,85 m	2	2
1,58 x 1,85 m	2	2

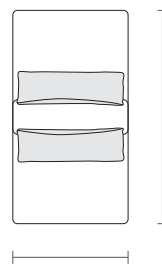

SB 1AS / SB 1AS	ASS	ENC
0,80 x 1,85 m	2	2
0,90 x 1,85 m	2	2
1,00 x 1,85 m	2	2
1,10 x 1,85 m	2	2
1,20 x 1,85 m	2	2
1,30 x 1,85 m	2	2

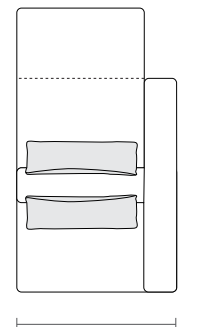

CH 1B 1AS / 1B 1AS	ASS	ENC
0,80 x 1,85 m	2	2
0,90 x 1,85 m	2	2
1,00 x 1,85 m	2	2
1,10 x 1,85 m	2	2
1,20 x 1,85 m	2	2
1,30 x 1,85 m	2	2

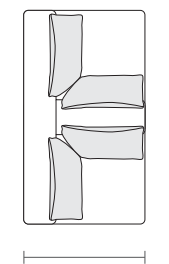

CTO / CTO	ASS	ENC
1,05 x 1,85 m	2	4

SB 1AS / SB 1AS