

CATÁLOGO DE **PRODUTOS**

PRODUCT CATALOGUE | CATALOGO DE PRODUCTOS

ponto**vírgula**

SOFÁS

SOFAS | SOFÁS

ponto**vírgula**

ALENTO

sofá living



ponto **vírgula**

ALENTO

sofá living

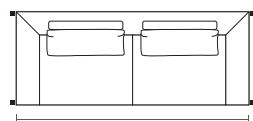
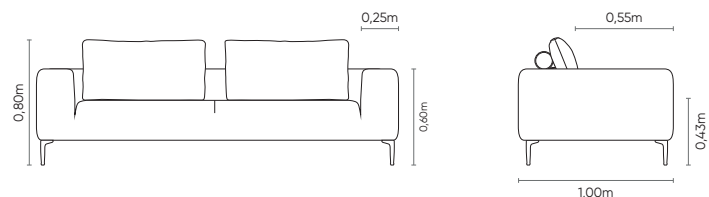

2B2	ASS	ENC	ROL
2,10 m	2	2	2
2,30 m	2	2	2
2,50 m	2	2	2
2,70 m	2	2	2
2,90 m	2	2	2
3,10 m	2	2	2

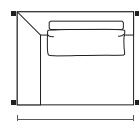

1B1 (D/E)	ASS	ENC	ROL
1,05 m	1	1	1
1,15 m	1	1	1
1,25 m	1	1	1
1,35 m	1	1	1
1,45 m	1	1	1
1,55 m	1	1	1

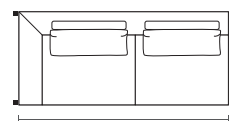

1B2 (D/E)	ASS	ENC	ROL
1,85 m	2	2	2
2,05 m	2	2	2
2,25 m	2	2	2
2,45 m	2	2	2
2,65 m	2	2	2
2,85 m	2	2	2

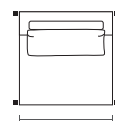

SB1 (D/E)	ASS	ENC	ROL
0,80 m	1	1	1
0,90 m	1	1	1
1,00 m	1	1	1
1,10 m	1	1	1
1,20 m	1	1	1
1,30 m	1	1	1

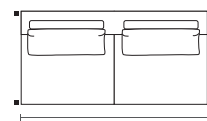

SB2 (D/E)	ASS	ENC	ROL
1,60 m	2	2	2
1,80 m	2	2	2
2,00 m	2	2	2
2,20 m	2	2	2
2,40 m	2	2	2
2,60 m	2	2	2

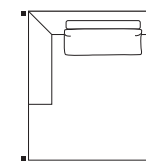

CH1B (D/E)	ASS	ENC	ROL
1,05 x 1,60 m	1	1	1
1,15 x 1,60 m	1	1	1
1,25 x 1,60 m	1	1	1
1,35 x 1,60 m	1	1	1
1,45 x 1,60 m	1	1	1
1,55 x 1,60 m	1	1	1

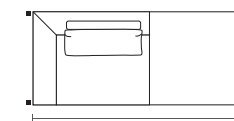

1B1 + PUFF BI (D/E)	ASS	ENC	ROL
1,05 m x 0,80 m	2	1	1
1,15 m x 0,90 m	2	1	1
1,25 m x 1,00 m	2	1	1
1,35 m x 1,10 m	2	1	1
1,45 m x 1,20 m	2	1	1
1,55 m x 1,30 m	2	1	1

Assento, encosto e braços fixos, sem detalhe de costura. Almofada de assento fixa sem detalhe de costura. Almofada de encosto solta, sem detalhe de costura, com rolinho de apoio. Almofada rolinho solta, com costura em pesponto simples. Pés em alumínio, disponíveis nos acabamentos MTX ou metalizado.

Fixed seat, backrest and armrests. Loose backrest cushion with cylindrical cushion for support. Aluminum feet, available in microtextured electrostatic or metallic finishes.

Asiento, respaldo y reposabrazos fijos. Cojín de respaldo suelto, cojín de apoyo cilíndrico. Pies de aluminio, disponibles en acabados metalizados.



ALENTO

sofá living

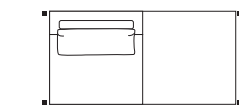
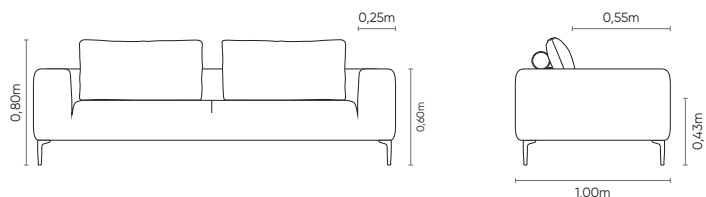

SB + PUFF BI (D/E)	ASS	ENC	ROL
0,80m x 0,80m	2	1	1
0,90m x 0,90m	2	1	1
1,00m x 1,00m	2	1	1
1,10m x 1,10m	2	1	1
1,20m x 1,20m	2	1	1
1,30m x 1,30m	2	1	1

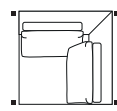

CTO (D/E)	ASS	ENC	ROL
1,00 x 1,00 m	1	2	2

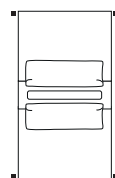

SB1 / SB1	ASS	ENC	ROL
0,80 x 1,80 m	2	2	1
0,90 x 1,80 m	2	2	1
1,00 x 1,80 m	2	2	1
1,10 x 1,80 m	2	2	1
1,20 x 1,80 m	2	2	1
1,30 x 1,80 m	2	2	1

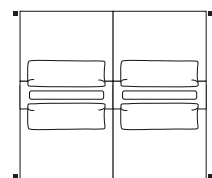

SB2 / SB2	ASS	ENC	ROL
1,60 x 1,80 m	4	4	2
1,80 x 1,80 m	4	4	2
2,00 x 1,80 m	4	4	2
2,20 x 1,80 m	4	4	2
2,40 x 1,80 m	4	4	2
2,60 x 1,80 m	4	4	2

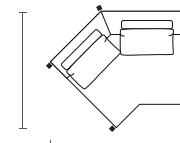

CTO 45°	ASS	ENC	ROL
1,20 x 1,15 m	1	2	2
1,40 x 1,25 m	1	2	2
1,60 x 1,35 m	1	2	2

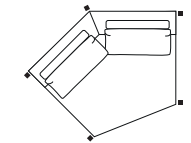

CTO CH 45° (D/E)	ASS	ENC	ROL
1,60 x 1,35 m	1	2	2

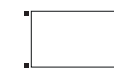

PUFF
0,80 x 0,60 m
0,90 x 0,60 m
1,00 x 0,60 m
1,10 x 0,60 m
1,20 x 0,60 m
1,30 x 0,60 m



PUFF / PUFF
0,90 x 1,80 m

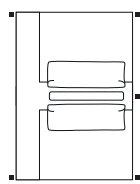

1B1 / 1B1 (D/E)	ASS	ENC	ROL
1,05m x 1,80m	2	2	1
1,15m x 1,80m	2	2	1
1,25m x 1,80m	2	2	1
1,35m x 1,80m	2	2	1
1,45m x 1,80m	2	2	1
1,55m x 1,80m	2	2	1

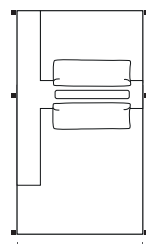

1B1 / CH 1B (D/E)	ASS	ENC	ROL
1,05m x 2,40m	2	2	1
1,15m x 2,40m	2	2	1
1,25m x 2,40m	2	2	1
1,35m x 2,40m	2	2	1
1,45m x 2,40m	2	2	1
1,55m x 2,40m	2	2	1

Assento, encosto e braços fixos, sem detalhe de costura. Almofada de assento fixa sem detalhe de costura. Almofada de encosto solta, sem detalhe de costura, com rolinho de apoio. Almofada rolinho solta, com costura em pesponto simples. Pés em alumínio, disponíveis nos acabamentos MTX ou metalizado.

Fixed seat, backrest and armrests. Loose backrest cushion with cylindrical cushion for support. Aluminum feet, available in microtextured electrostatic or metallic finishes.

Asiento, respaldo y reposabrazos fijos. Cojín de respaldo suelto, cojín de apoyo cilíndrico. Pies de aluminio, disponibles en acabados metalizados.



Amber



SOFÁS
SOFAS | SOFÁS

ponto**vírgula**



Amber

SOFÁS
SOFAS | SOFÁS

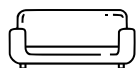

Amber

SOFÁS
SOFAS | SOFÁS

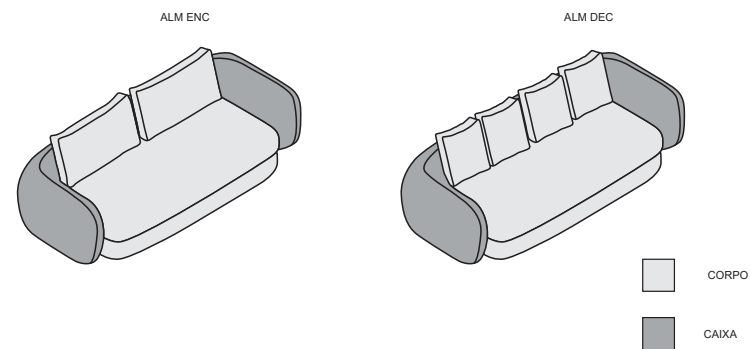
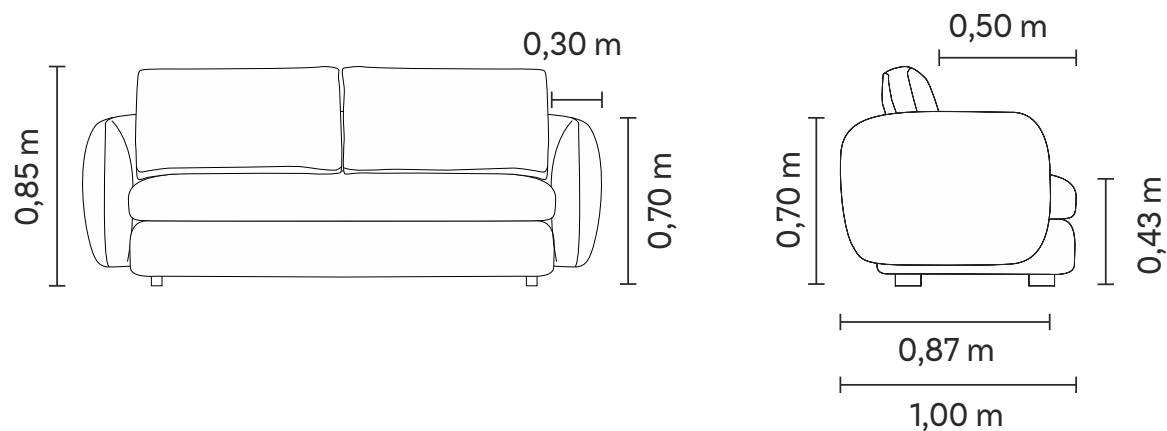

Assento, encosto e braços fixos sem detalhe de costura. Almofada de assento fixa com costura em pesponto simples. Opção de almofada de encosto solta sem detalhe de costura ou almofada decorativa solta, sem detalhe de costura. Pés em polipropileno injetado na cor preta.

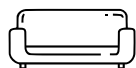

Amber

SOFÁS
SOFAS | SOFÁS

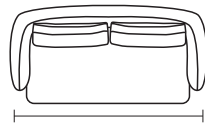

2B1	ASS	DEC	ENC
2,00 m	1	4	2
2,20 m	1	4	2
2,40 m	1	6	2
2,60 m	1	6	2
2,80 m	1	6	2
3,00 m	1	6	2



1B1	ASS	DEC	ENC
1,10 m	1	2	1
1,20 m	1	2	1
1,30 m	1	3	1
1,40 m	1	3	1
1,50 m	1	3	1

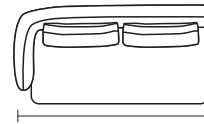

1B1	ASS	DEC	ENC
1,90 m	1	4	2
2,10 m	1	4	2
2,30 m	1	6	2
2,50 m	1	6	2
2,70 m	1	6	2



SB1	ASS	DEC	ENC
0,80 m	1	2	1
0,90 m	1	2	1
1,00 m	1	3	1
1,10 m	1	3	1
1,20 m	1	3	1

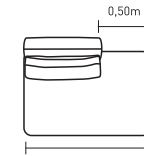

SB BI	ASS	DEC	ENC
1,30 m	1	2	1
1,40 m	1	2	1
1,50 m	1	3	1
1,60 m	1	3	1
1,70 m	1	3	1

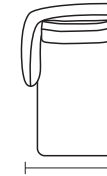

CH 1B	ASS	DEC	ENC
1,10x1,60 m	1	2	1
1,20x1,60 m	1	2	1
1,30x1,60 m	1	3	1
1,40x1,60 m	1	3	1
1,50x1,60 m	1	3	1



CH SB	ASS	DEC	ENC
0,80x1,60 m	1	2	1
0,90x1,60 m	1	2	1
1,00x1,60 m	1	3	1
1,10x1,60 m	1	3	1
1,20x1,60 m	1	3	1

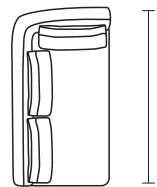

CEV ATF	ASS	DEC	ENC
1,00x1,90 m	1	4	3
1,00x2,10 m	1	5	3
1,00x2,30 m	1	5	3
1,00x2,50 m	1	6	3
1,00x2,70 m	1	6	3



CTO	ASS	DEC	ENC
1,00x1,00 m	1	3	2



PUFF CTO
0,70x0,70 m

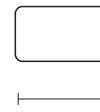

PUFF
0,80x0,60 m
0,90x0,60 m
1,00x0,60 m
1,10x0,60 m
1,20x0,60 m

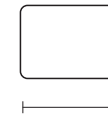

PUFF MEIO
0,80x0,70 m
0,90x0,70 m
1,00x0,70 m
1,10x0,70 m
1,20x0,70 m

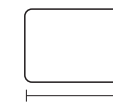

PUFF BI
0,80x0,70 m
0,90x0,70 m
1,00x0,70 m
1,10x0,70 m
1,20x0,70 m

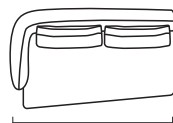

1B1 ANG	ASS	DEC	ENC
1,90x1,15 m	1	4	2
2,10x1,15 m	1	4	2
2,30x1,15 m	1	6	2
2,50x1,15 m	1	6	2
2,70x1,15 m	1	6	2

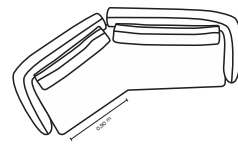

Lado referenciado é pelo lado fixo

2B CURVO (E)	ASS	DEC	ENC
2,80x1,60 m	1	4	3
2,90x1,60 m	1	4	3
3,00x1,60 m	1	5	3
3,10x1,60 m	1	5	3
3,20x1,60 m	1	5	3
3,30x1,60 m	1	5	3

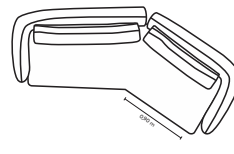

Lado referenciado é pelo lado fixo

2B CURVO (D)	ASS	DEC	ENC
2,80x1,60 m	1	4	3
2,90x1,60 m	1	4	3
3,00x1,60 m	1	5	3
3,10x1,60 m	1	5	3
3,20x1,60 m	1	5	3
3,30x1,60 m	1	5	3

Arlo



SOFÁS
SOFAS | SOFÁS

pontovírgula



Arlo

SOFÁS
SOFAS | SOFÁS

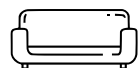

Arlo

SOFÁS
SOFAS | SOFÁS

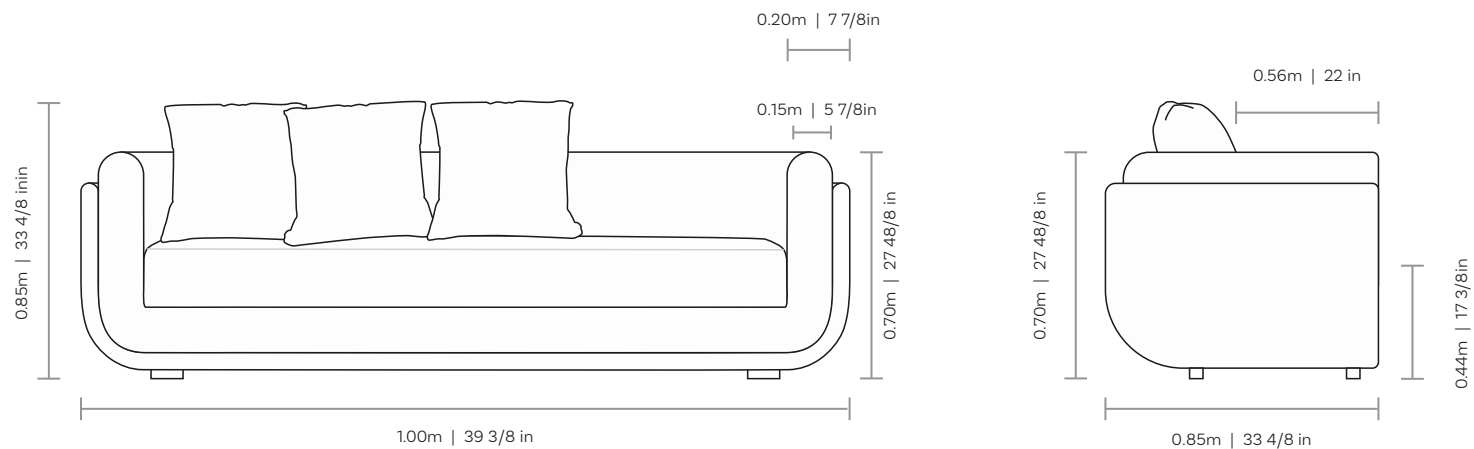

Assento e braços fixos, com costura em pesponto simples. Encosto fixo com costura em pesponto duplo. Almofada de assento com costura em pesponto simples, espumas em eco-espuma, D26 e D20 soft, envoltas em manta siliconada. Pés em polipropileno na cor preta.

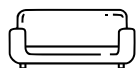

Arlo

SOFÁS
SOFAS | SOFÁS

2 BRAÇOS 1 ASSENTO

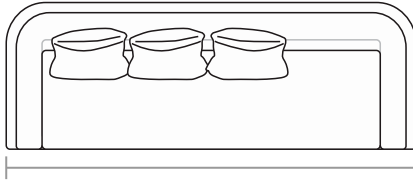

DIMENSÕES	ALMOFADAS
DIMENSIONS DIMENSIONES	CUSHIONS COJINES
1.80m 70 7/8in	2
2.00m 78 6/8in	2
2.20m 86 5/8in	3
2.40m 94 4/8in	3
2.60m 102 3/8in	3
2.80m 110 2/8in	4
3.00m 118 1/8in	4

1 BRAÇO 1 ASSENTO

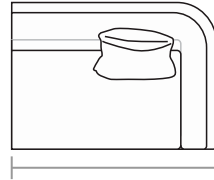

DIMENSÕES	ALMOFADAS
DIMENSIONS DIMENSIONES	CUSHIONS COJINES
1.00m 39 3/8in	1
1.10m 43 2/8in	1
1.20m 47 2/8in	1
1.30m 51 1/8in	2
1.40m 55 1/8in	2
1.50m 59in	2

SEM BRAÇOS 1 ASSENTO

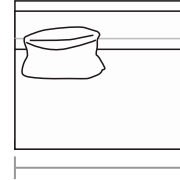

DIMENSÕES	ALMOFADAS
DIMENSIONS DIMENSIONES	CUSHIONS COJINES
0.80m 31 4/8in	1
0.90m 35 3/8in	1
1.00m 39 3/8in	1
1.10m 43 2/8in	2
1.20m 47 2/8in	2
1.30m 51 1/8in	2

PUFF BI



DIMENSÕES
DIMENSIONS DIMENSIONES
0.80m 31 4/8in
0.90m 35 3/8in
1.00m 39 3/8in
1.10m 43 2/8in
1.20m 47 2/8in
1.30m 51 1/8in

CANTO (CTO)



DIMENSÕES	ALMOFADAS
DIMENSIONS DIMENSIONES	CUSHIONS COJINES
0.85m 33 4/8in	3

PUFF MEIO



DIMENSÕES
DIMENSIONS DIMENSIONES
0.80m 31 4/8in
0.90m 35 3/8in
1.00m 39 3/8in
1.10m 43 2/8in
1.20m 47 2/8in
1.30m 51 1/8in

CH EV ATF

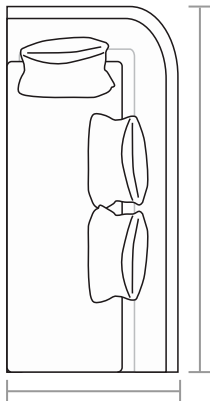

DIMENSÕES	ALMOFADAS
DIMENSIONS DIMENSIONES	CUSHIONS COJINES
0.85m x 1.50m 33 4/8in x 63in	3
0.85m x 1.70m 33 4/8in x 66 7/8in	3
0.85m x 1.80m 33 4/8in x 70 7/8in	3
0.85m x 1.90m 33 4/8in x 74 6/8in	4
0.85m x 2.00m 33 4/8in x 78 6/8in	4
0.85m x 2.10m 33 4/8in x 82 5/8in	4

PUFF

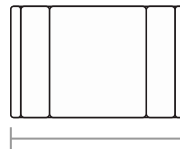

DIMENSÕES
DIMENSIONS DIMENSIONES
1.00m x 0.60m 39 3/8in x 23 5/8in

POLTRONA

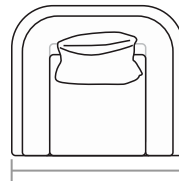

DIMENSÕES	ALMOFADAS
DIMENSIONS DIMENSIONES	CUSHIONS COJINES
1.00m x 0.85m 39 3/8in x 33 4/8in	1

BANCO BAIXO

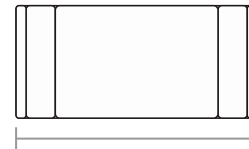

DIMENSÕES
DIMENSIONS DIMENSIONES
1.10m x 0.60m 43 2/8in x 23 5/8in
1.20m x 0.60m 47 2/8in x 23 5/8in
1.30m x 0.60m 51 1/8in x 23 5/8in
1.40m x 0.60m 55 1/8in x 23 5/8in
1.50m x 0.60m 59in

BANCO ALTO

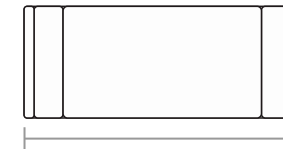

DIMENSÕES
DIMENSIONS DIMENSIONES
1.10m x 0.60m 43 2/8in x 23 5/8in
1.20m x 0.60m 47 2/8in x 23 5/8in
1.30m x 0.60m 51 1/8in x 23 5/8in
1.40m x 0.60m 55 1/8in x 23 5/8in
1.50m x 0.60m 59in

Atto



SOFÁS
SOFÁS | SOFÁS

pontovírgula



Atto

SOFÁS
SOFÁS | SOFÁS

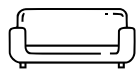

Atto

SOFÁS
SOFÁS | SOFÁS

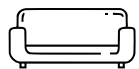
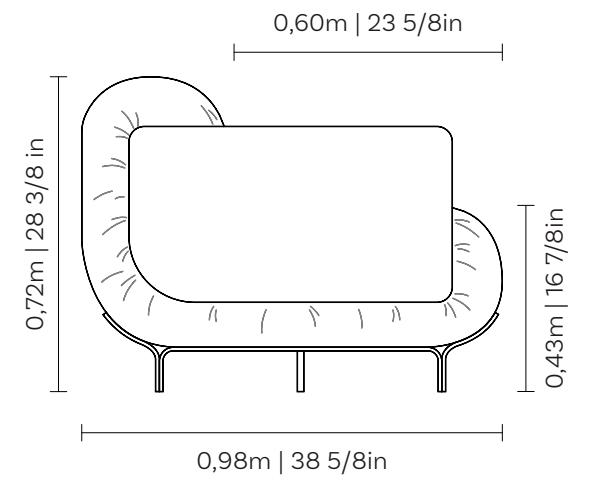
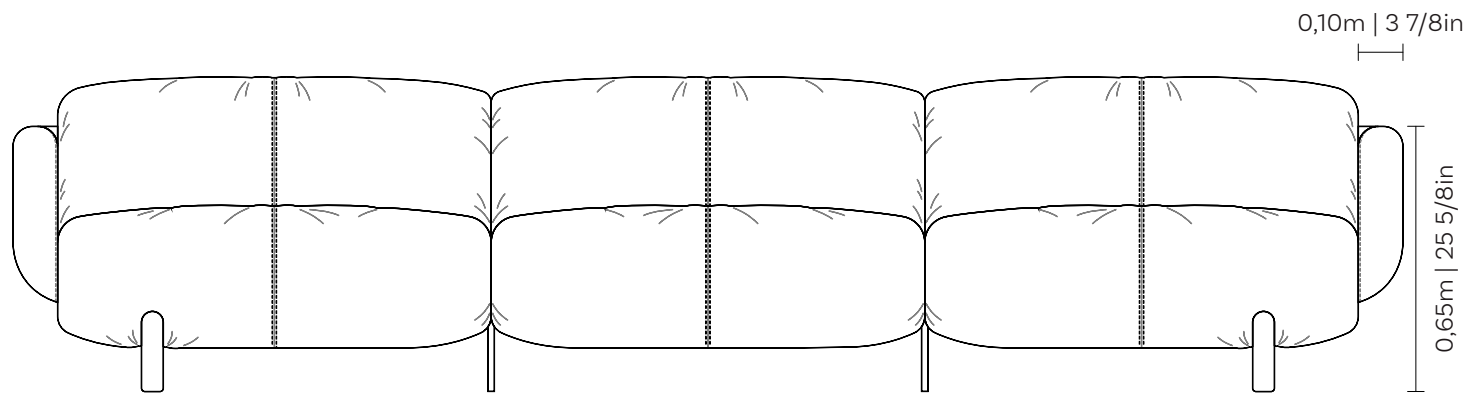

ponto**vírgula**

Atto

SOFÁS
SOFÁS | SOFÁS

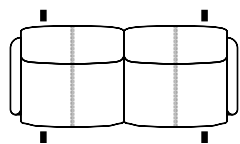

2B 2AS		ASS
1,80 m x 0,98 m	70 7/8 x 38 5/8 in	2
2,00 m x 0,98 m	78 6/8 x 38 5/8 in	2
2,20 m x 0,98 m	86 5/8 x 38 5/8 in	2
2,40 m x 0,98 m	94 4/8 x 38 5/8 in	2
2,60 m x 0,98 m	102 3/8 x 38 5/8 in	2

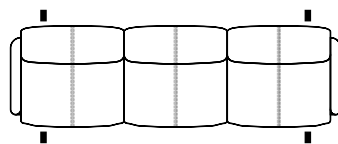

2B 3AS		ASS
2,90 m x 0,98 m	114 1/8 x 38 5/8 in	3
3,20 m x 0,98 m	126 x 38 5/8 in	3

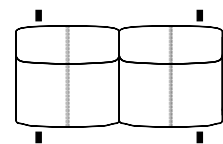

1B 2AS		ASS
1,70 m x 0,98 m	66 7/8 x 38 5/8 in	2
1,90 m x 0,98 m	74 6/8 x 38 5/8 in	2
2,10 m x 0,98 m	82 5/8 x 38 5/8 in	2
2,30 m x 0,98 m	90 4/8 x 38 5/8 in	2
2,50 m x 0,98 m	98 3/8 x 38 5/8 in	2

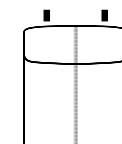

CH 1AS (D/E)		ASS
0,90 m x 1,40 m	35 3/8 x 55 1/8 in	1
1,00 m x 1,40 m	39 3/8 x 55 1/8 in	1
1,10 m x 1,40 m	43 2/8 x 55 1/8 in	1
1,20 m x 1,40 m	47 2/8 x 55 1/8 in	1
1,30 m x 1,40 m	51 1/8 x 55 1/8 in	1

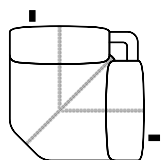

CTO CH		ASS
1,30 m x 1,30 m	51 1/8 x 51 1/8 in	1

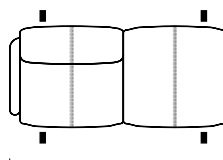

1B 1AS + PUFF MEIO (D/E)		ASS
1,70 m x 0,98 m	66 7/8 x 38 5/8 in	2
1,90 m x 0,98 m	74 6/8 x 38 5/8 in	2
2,10 m x 0,98 m	82 5/8 x 38 5/8 in	2
2,30 m x 0,98 m	90 4/8 x 38 5/8 in	2
2,40 m x 0,98 m	98 3/8 x 38 5/8 in	2

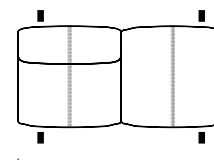

SB 1AS + PUFF BI (D/E)		ASS
1,60 m x 0,98 m	63 x 38 5/8 in	2
1,80 m x 0,98 m	70 7/8 x 38 5/8 in	2
2,00 m x 0,98 m	78 6/8 x 38 5/8 in	2
2,20 m x 0,98 m	86 5/8 x 38 5/8 in	2
2,40 m x 0,98 m	94 4/8 x 38 5/8 in	2

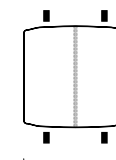

PUFF		ASS
0,60 m x 0,80 m	23 5/8 x 31 4/8 in	1
0,70 m x 0,80 m	27 4/8 x 31 4/8 in	1
1,00 m x 1,00 m	39 3/8 x 39 3/8 in	1

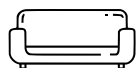

ponto**vírgula**

Atto

SOFÁS
SOFÁS | SOFÁS

Assento: pillow fixo, com costura em pesponto duplo.
Encosto: pillow fixo, com costura em pesponto duplo.
Braço: fixo, se detalhe de costura
Suporte: pés em aço carbono, disponível nos acabamentos pintura MTX.

Medidas podem apresentar leves variações. Nos reservamos o direito de efetuar alterações sem consulta prévia.

Seat: Fixed pillow, with double topstitching.
Backrest: Fixed pillow, with double topstitching.
Arm: Fixed, without stitching details.
Support: Carbon steel legs, available in MTX paint, matte paint, and metallic paint finishes.

Measures may vary slightly. We reserve the right to make changes without prior consultation.

*For more information, see our Comfort Guide.

Asiento: Cojín fijo, con pespunte doble.
Respaldo: Cojín fijo, con pespunte doble.
Brazo: Fijo, sin detalle de costura.
Soporte: Patas en acero al carbono, disponibles en acabados pintura MTX, pintura mate y pintura metalizada.

Las medidas pueden variar un poco. Nos reservamos el derecho de realizar cambios sin previa consulta.

*Para más informaciones, consulte nuestro Guía de Confort.

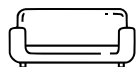

ponto**vírgula**

Bold



SOFÁS
SOFÁS | SOFÁS

ponto**vírgula**



Bold

SOFÁS
SOFÁS | SOFÁS

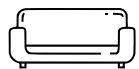

Bold

SOFÁS
SOFÁS | SOFÁS

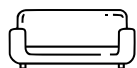
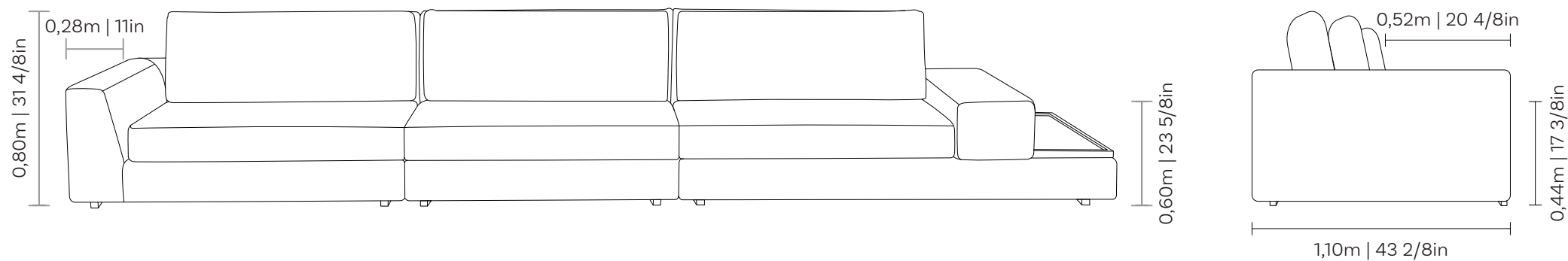

Bold

SOFÁS
SOFÁS | SOFÁS

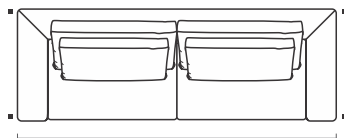

2B2		ASS	ENC	LOMB
2,10 x 1,10 m	82 5/8 x 43 2/8 in	2	2	2
2,30 x 1,10 m	90 4/8 x 43 2/8 in	2	2	2
2,50 x 1,10 m	98 3/8 x 43 2/8 in	2	2	2
2,70 x 1,10 m	106 2/8 x 43 2/8 in	2	2	2
2,90 x 1,10 m	114 1/8 x 43 2/8 in	2	2	2
3,10 x 1,10 m	122 x 43 2/8 in	2	2	2

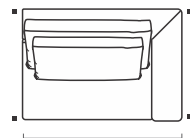

1B 1AS		ASS	ENC	LOMB
1,05 x 1,10 m	41 3/8 x 43 2/8 in	1	1	1
1,15 x 1,10 m	45 2/8 x 43 2/8 in	1	1	1
1,25 x 1,10 m	49 2/8 x 43 2/8 in	1	1	1
1,35 x 1,10 m	53 1/8 x 43 2/8 in	1	1	1
1,45 x 1,10 m	57 1/8 x 43 2/8 in	1	1	1
1,55 x 1,10 m	61 x 43 2/8 in	1	1	1

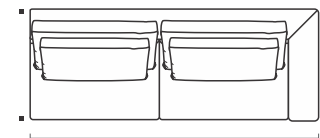

1B 2AS		ASS	ENC	LOMB
1,82 x 1,10 m	71 5/8 x 43 2/8 in	2	2	2
2,02 x 1,10 m	79 4/8 x 43 2/8 in	2	2	2
2,22 x 1,10 m	87 3/8 x 43 2/8 in	2	2	2
2,42 x 1,10 m	95 2/8 x 43 2/8 in	2	2	2
2,62 x 1,10 m	103 1/8 x 43 2/8 in	2	2	2
2,82 x 1,10 m	111 x 43 2/8 in	2	2	2

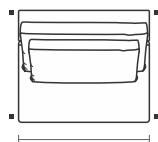

SB1		ASS	ENC	LOMB
0,77 x 1,10 m	30 3/8 x 43 2/8 in	1	1	1
0,87 x 1,10 m	34 2/8 x 43 2/8 in	1	1	1
0,97 x 1,10 m	38 2/8 x 43 2/8 in	1	1	1
1,07 x 1,10 m	42 1/8 x 43 2/8 in	1	1	1
1,17 x 1,10 m	46 1/8 x 43 2/8 in	1	1	1
1,27 x 1,10 m	50 x 43 2/8 in	1	1	1

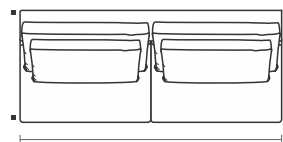

SB2		ASS	ENC	LOMB
1,54 x 1,10 m	60 5/8 x 43 2/8 in	2	2	2
1,74 x 1,10 m	68 4/8 x 43 2/8 in	2	2	2
1,94 x 1,10 m	76 3/8 x 43 2/8 in	2	2	2
2,14 x 1,10 m	84 2/8 x 43 2/8 in	2	2	2
2,34 x 1,10 m	92 1/8 x 43 2/8 in	2	2	2
2,54 x 1,10 m	100 x 43 2/8 in	2	2	2

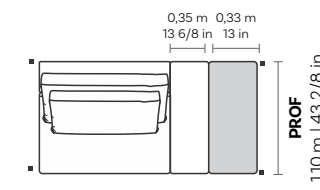

1B1 BDJ		ASS	ENC	LOMB
1,52 x 1,10 m	59 7/8 x 43 2/8 in	1	1	1
1,62 x 1,10 m	63 6/8 x 43 2/8 in	1	1	1
1,72 x 1,10 m	67 6/8 x 43 2/8 in	1	1	1
1,82 x 1,10 m	71 5/8 x 43 2/8 in	1	1	1
1,92 x 1,10 m	75 5/8 x 43 2/8 in	1	1	1
2,02 x 1,10 m	79 4/8 x 43 2/8 in	1	1	1

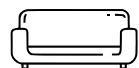

Bold

SOFÁS
SOFÁS | SOFÁS



CTO
1,10 x 1,10 m | 43 2/8 x 43 2/8 in
ASS 1 **ENC** 2 **LOMB** 2

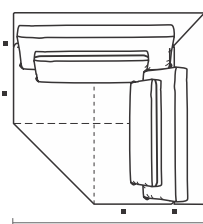

CTO CH
1,75 x 1,75 m | 68 7/8 x 68 7/8 in
ASS 1 **ENC** 2 **LOMB** 2

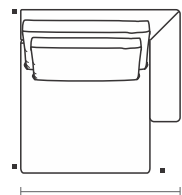

CH 1B
1,15 x 1,60 m | 45 2/8 x 63 in
1,25 x 1,60 m | 49 2/8 x 63 in
1,35 x 1,60 m | 53 1/8 x 63 in
ASS 1 **ENC** 1 **LOMB** 2
1 1 2
1 1 2

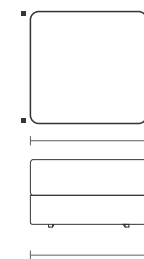

PUFF
0,70 x 1,10 m | 27 4/8 x 43 2/8 in
0,90 x 1,10 m | 35 3/8 x 43 2/8 in
1,10 x 1,10 m | 43 2/8 x 43 2/8 in

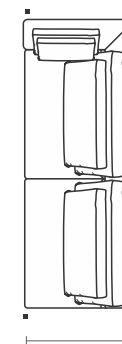

CEV
1,10 x 1,82 m | 43 2/8 x 71 5/8 in
1,10 x 2,02 m | 43 2/8 x 79 4/8 in
1,10 x 2,22 m | 43 2/8 x 87 3/8 in
1,10 x 2,42 m | 43 2/8 x 95 2/8 in
1,10 x 2,62 m | 43 2/8 x 103 1/8 in
1,10 x 2,82 m | 43 2/8 x 103 1/8 in
ASS 2 **ENC** 3 **LOMB** 3
2 3 3
2 3 3
2 3 3
2 3 3
2 3 3

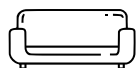

Bold

SOFÁS
SOFÁS | SOFÁS

Encosto: fixo, com costura em pesponto simples.
Braço: fixo, com costura em pesponto simples.
Pés: em polipropileno injetado na cor preta.
Bandeja: em MDF, nos acabamentos laminado, laqueado, laqueado metalizado e verniz.
Almofada de assento: fixo, com costura em pesponto simples.
Almofada de encosto: solta, costurada em pesponto simples.
Almofada lombar: 10 cm menor que o comprimento do assento costurada em pesponto simples.

Medidas podem apresentar leves variações. Nos reservamos o direito de efetuar alterações sem consulta prévia.

Backrest: fixed, with simple backstitch.
Armrests: fixed, with simple backstitch.
Feet: black injected polypropylene.
Tray: in MDF, in laminate, lacquered, metallized lacquered and varnish finishes.
Seat cushion: fixed, with simple backstitch.
Backrest cushion: loose, with simple backstitch.
Lumbar cushion: 10 cm shorter than the length of the seat seam in simple topstitching.

Measures may vary slightly. We reserve the right to make changes without prior consultation.
*For more information, see our Comfort Guide.

Respaldo: fijo, con costuras simples.
Brazos: fijos, con costuras simples.
Patas: polipropileno inyectado en color negro.
Bandeja: en MDF, en laminado, lacado, lacado metalizado y barnizado.
Cojín de asiento: fijo, con costuras simples.
Cojín de respaldo: suelto, con costuras simples.
Cojín lumbar: 10 cm más corto que la longitud de la costura del asiento en pespuntos sencillos.

Las medidas pueden variar un poco. Nos reservamos el derecho de realizar cambios sin previa consulta.
*Para más informaciones, consulte nuestro Guía de Confort.

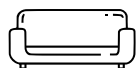

ponto**vírgula**

Bonobo



SOFÁS
SOFAS | SOFÁS

ponto**vírgula**



Bonobo

SOFÁS ARTICULADOS
ARTICULATED SOFAS | SOFÁS ARTICULADOS

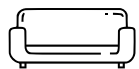
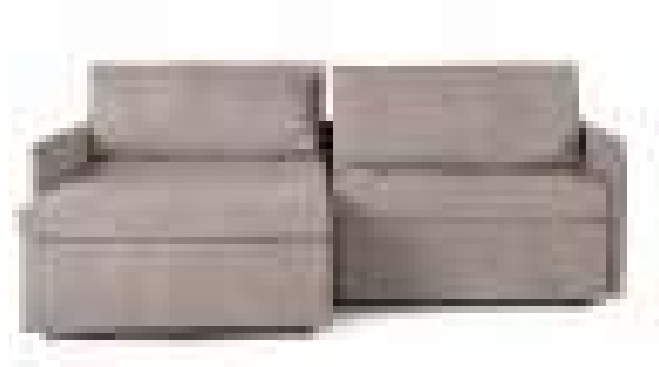
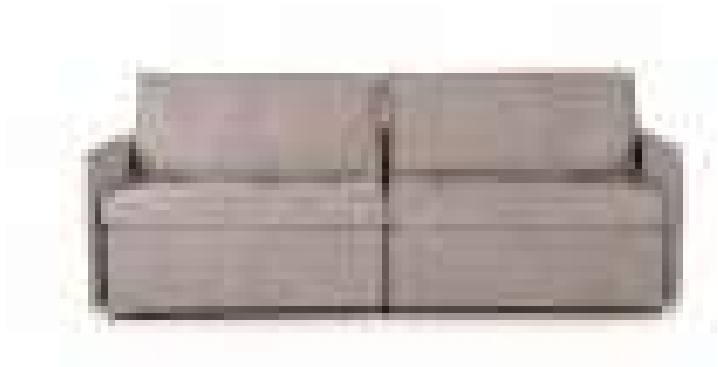

Bonobo

SOFÁS ARTICULADOS
ARTICULATED SOFAS | SOFÁS ARTICULADOS

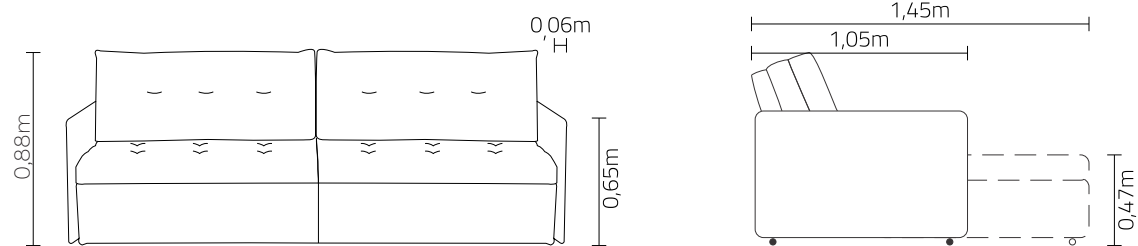

Assento retrátil com abertura de 40cm sem detalhe de costura. Almofada de assento fixa com detalhes em ponto puxado. Encosto fixo com costura em fole e detalhes em ponto puxado. Braço fixo com costura em fole. Capa de almofada decorativa, de 55x45cm, sem detalhe de costura, com enchimento em matelassê dobrado para cobertura do sofá cama. Pés em polipropileno injetado na cor preta.

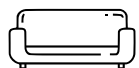

Bonobo

SOFÁS ARTICULADOS
ARTICULATED SOFAS | SOFÁS ARTICULADOS

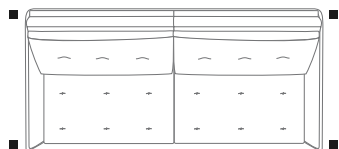

2B2	ASS	ENC
1,40 m	2	2
1,60 m	2	2
1,80 m	2	2
2,00 m	2	2
2,20 m	2	2
2,40 m	2	2

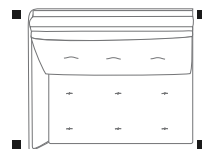

1B1 (D/E)	ASS	ENC
0,70 m	1	1
0,80 m	1	1
0,90 m	1	1
1,00 m	1	1
1,10 m	1	1
1,20 m	1	1
1,30 m	1	1
1,40 m	1	1

Cliff



SOFÁS
SOFÁS | SOFÁS

ponto**vírgula**



Cliff

SOFÁS
SOFÁS | SOFÁS

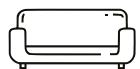

Cliff

SOFÁS
SOFÁS | SOFÁS

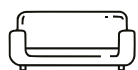
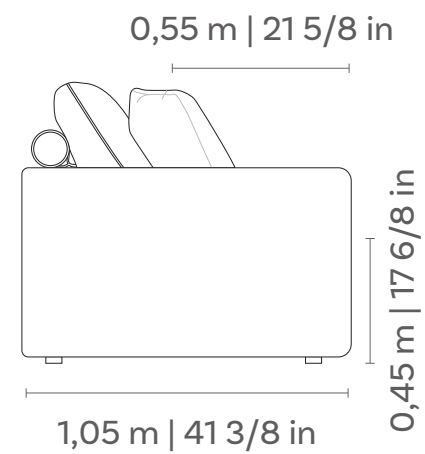
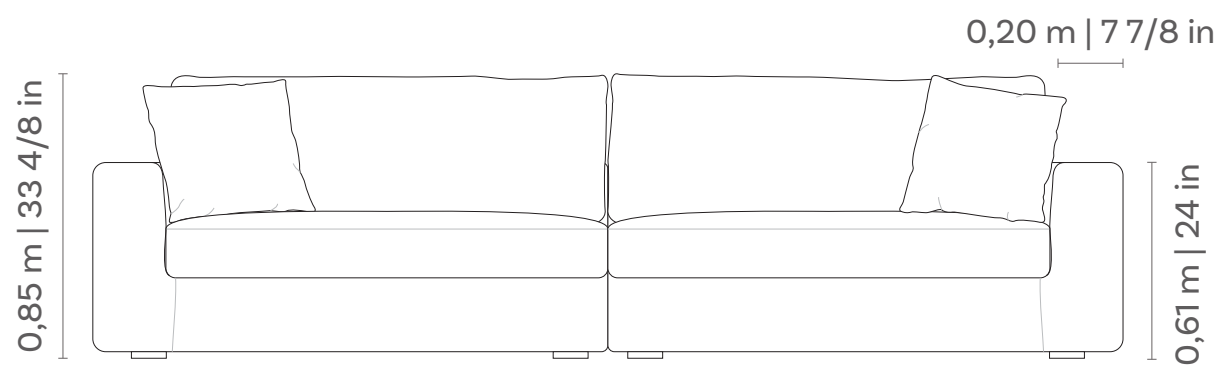

Cliff

SOFÁS
SOFÁS | SOFÁS

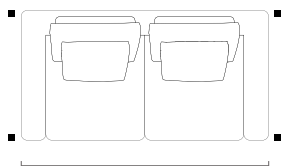

2B2	ASS	ENC	DEC
2,00 m x 1,05 m 78 6/8 x 41 3/8 in	2	2	2
2,20 m x 1,05 m 86 5/8 x 41 3/8 in	2	2	2
2,40 m x 1,05 m 94 4/8 x 41 3/8 in	2	2	2
2,60 m x 1,05 m 102 3/8 x 41 3/8 in	2	2	2
2,80 m x 1,05 m 110 2/8 x 41 3/8 in	2	2	2
3,00 m x 1,05 m 118 1/8 x 41 3/8 in	2	2	2
3,20 m x 1,05 m 126 x 41 3/8 in	2	2	2

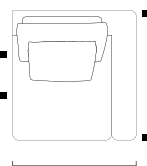

1B1 (D/E)	ASS	ENC	DEC
1,00 m x 1,05 m 39 3/8 x 41 3/8 in	1	1	1
1,10 m x 1,05 m 43 2/8 x 41 3/8 in	1	1	1
1,20 m x 1,05 m 47 2/8 x 41 3/8 in	1	1	1
1,30 m x 1,05 m 51 1/8 x 41 3/8 in	1	1	1
1,40 m x 1,05 m 55 1/8 x 41 3/8 in	1	1	1
1,50 m x 1,05 m 59 x 41 3/8 in	1	1	1
1,60 m x 1,05 m 63 x 41 3/8 in	1	1	1

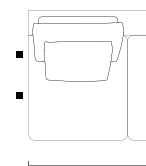

SB 1AS ACCESS-REVISTEIRO (D/E)	ASS	ENC	DEC
1,00 m x 1,05 m 39 3/8 x 41 3/8 in	1	1	1
1,10 m x 1,05 m 43 2/8 x 41 3/8 in	1	1	1
1,20 m x 1,05 m 47 2/8 x 41 3/8 in	1	1	1
1,30 m x 1,05 m 51 1/8 x 41 3/8 in	1	1	1
1,40 m x 1,05 m 55 1/8 x 41 3/8 in	1	1	1
1,50 m x 1,05 m 59 x 41 3/8 in	1	1	1
1,60 m x 1,05 m 63 x 41 3/8 in	1	1	1

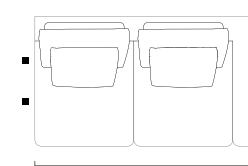

1B2 (D/E)	ASS	ENC	DEC
1,80 m x 1,05 m 70 7/8 x 41 3/8 in	2	2	1
2,00 m x 1,05 m 78 6/8 x 41 3/8 in	2	2	1
2,20 m x 1,05 m 86 5/8 x 41 3/8 in	2	2	1
2,40 m x 1,05 m 94 4/8 x 41 3/8 in	2	2	1
2,60 m x 1,05 m 102 3/8 x 41 3/8 in	2	2	1
2,80 m x 1,05 m 110 2/8 x 41 3/8 in	2	2	1
3,00 m x 1,05 m 118 1/8 x 41 3/8 in	2	2	1

*OBS.: Revestiro utiliza-se como uma opção de substituição do braço, sendo assim um módulo de finalização.

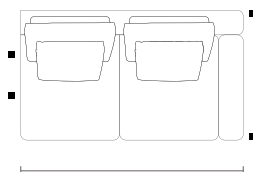

SB 2AS ACCESS-REVISTEIRO (D/E)	ASS	ENC	DEC
1,80 m x 1,05 m 70 7/8 x 41 3/8 in	2	2	1
2,00 m x 1,05 m 78 6/8 x 41 3/8 in	2	2	1
2,20 m x 1,05 m 86 5/8 x 41 3/8 in	2	2	1
2,40 m x 1,05 m 94 4/8 x 41 3/8 in	2	2	1
2,60 m x 1,05 m 102 3/8 x 41 3/8 in	2	2	1
2,80 m x 1,05 m 110 2/8 x 41 3/8 in	2	2	1
3,00 m x 1,05 m 118 1/8 x 41 3/8 in	2	2	1

*OBS.: Revestiro utiliza-se como uma opção de substituição do braço, sendo assim um módulo de finalização.

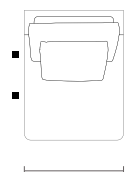

SB 1	ASS	ENC
0,80 m x 1,05 m 31 4/8 x 41 3/8 in	1	1
0,90 m x 1,05 m 35 3/8 x 41 3/8 in	1	1
1,00 m x 1,05 m 39 3/8 x 41 3/8 in	1	1
1,10 m x 1,05 m 43 2/8 x 41 3/8 in	1	1
1,20 m x 1,05 m 47 2/8 x 41 3/8 in	1	1
1,30 m x 1,05 m 51 1/8 x 41 3/8 in	1	1
1,40 m x 1,05 m 55 1/8 x 41 3/8 in	1	1

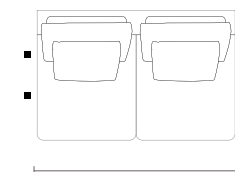

SB 2	ASS	ENC
1,60 m x 1,05 m 63 x 41 3/8 in	2	2
1,80 m x 1,05 m 70 7/8 x 41 3/8 in	2	2
2,00 m x 1,05 m 78 6/8 x 41 3/8 in	2	2
2,20 m x 1,05 m 86 5/8 x 41 3/8 in	2	2
2,40 m x 1,05 m 94 4/8 x 41 3/8 in	2	2
2,60 m x 1,05 m 102 3/8 x 41 3/8 in	2	2
2,80 m x 1,05 m 110 2/8 x 41 3/8 in	2	2

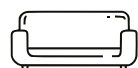

Cliff

SOFÁS
SOFÁS | SOFÁS

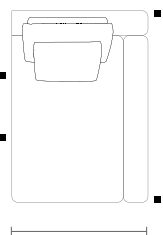

CH SB ACCESS: REVISTEIRO (D/E)	ASS	ENC	DEC
1,10 x 1,55 m 43 2/8 x 61 in	1	1	1
1,20 x 1,55 m 47 2/8 x 61 in	1	1	1
1,40 x 1,75 m 55 1/8 x 68 7/8 in	1	1	1
1,50 x 1,75 m 59 x 68 7/8 in	1	1	1

*OBS.: Revisteiro utiliza-se como uma opção de substituição do braço, sendo assim um módulo de finalização.

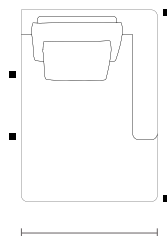

CH 1B (D/E)	ASS	ENC	DEC
1,10 x 1,55 m 43 2/8 x 61 in	1	1	1
1,20 x 1,55 m 47 2/8 x 61 in	1	1	1
1,40 x 1,75 m 55 1/8 x 68 7/8 in	1	1	1
1,50 x 1,75 m 59 x 68 7/8 in	1	1	1

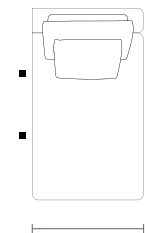

CH SB	ASS	ENC
0,90 m x 1,55 m 35 3/8 x 61 in	1	1
1,00 m x 1,55 m 39 3/8 x 61 in	1	1
1,20 m x 1,75 m 47 2/8 x 68 7/8 in	1	1
1,30 m x 1,75 m 51 1/8 x 68 7/8 in	1	1

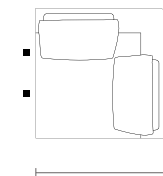

CTO	ASS	ENC
1,05 m x 1,05 m 41 3/8 x 41 3/8 in	1	2



PUFF
0,80 m x 0,65 m 31 4/8 x 25 5/8 in
0,90 m x 0,65 m 35 3/8 x 25 5/8 in
1,00 m x 0,65 m 39 3/8 x 25 5/8 in
1,10 m x 0,65 m 43 2/8 x 25 5/8 in
1,20 m x 0,65 m 47 2/8 x 25 5/8 in
1,30 m x 0,65 m 51 1/8 x 25 5/8 in
1,40 m x 0,65 m 55 1/8 x 25 5/8 in



PUFF
1,00 m x 0,50 m 39 3/8 x 19 5/8 in
1,00 m x 0,60 m 39 3/8 x 23 5/8 in
1,10 m x 0,70 m 43 2/8 x 27 4/8 in
1,10 m x 0,80 m 43 2/8 x 31 4/8 in

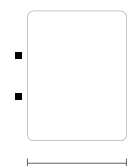

PUFF MEIO
0,80 m x 1,05 m 31 4/8 x 41 3/8 in
0,90 m x 1,05 m 35 3/8 x 41 3/8 in
1,00 m x 1,05 m 39 3/8 x 41 3/8 in
1,10 m x 1,05 m 43 2/8 x 41 3/8 in
1,20 m x 1,05 m 47 2/8 x 41 3/8 in
1,30 m x 1,05 m 51 1/8 x 41 3/8 in
1,40 m x 1,05 m 55 1/8 x 41 3/8 in

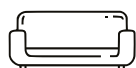

Cliff

SOFÁS
SOFÁS | SOFÁS

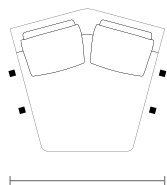

SB CURVO
1,25 m x 1,15 m | 49 2/8 x 45 2/8 in
ASS 1 ENC 2

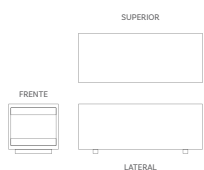

APARADOR
0,40 m x 1,00 m | 15 6/8 x 39 3/8 in

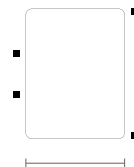

PUFF BI (D/E)
0,80 m x 1,05 m | 31 4/8 x 41 3/8 in
0,90 m x 1,05 m | 35 3/8 x 41 3/8 in
1,00 m x 1,05 m | 39 3/8 x 41 3/8 in
1,10 m x 1,05 m | 43 2/8 x 41 3/8 in
1,20 m x 1,05 m | 47 2/8 x 41 3/8 in
1,30 m x 1,05 m | 51 1/8 x 41 3/8 in
1,40 m x 1,05 m | 55 1/8 x 41 3/8 in

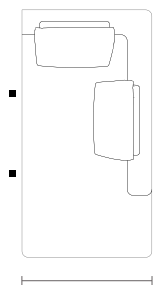

CEV (D/E)
1,05 m x 2,00 m | 41 3/8 x 78 6/8 in
1,05 m x 2,20 m | 41 3/8 x 86 5/8 in
1,05 m x 2,40 m | 41 3/8 x 94 4/8 in
1,05 m x 2,60 m | 41 3/8 x 102 3/8 in
1,05 m x 2,80 m | 41 3/8 x 110 2/8 in
1,05 m x 3,00 m | 41 3/8 x 118 1/8 in
1,05 m x 3,20 m | 41 3/8 x 126 in
ASS 1 ENC 2

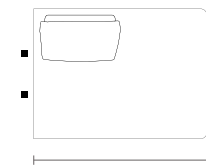

SB BI
1,40 m x 1,05 m | 55 1/8 x 41 3/8 in
1,50 m x 1,05 m | 59 x 41 3/8 in
1,60 m x 1,05 m | 63 x 41 3/8 in
1,70 m x 1,05 m | 66 7/8 x 41 3/8 in
1,80 m x 1,05 m | 70 7/8 x 41 3/8 in
1,90 m x 1,05 m | 74 6/8 x 41 3/8 in
2,00 m x 1,05 m | 78 6/8 x 41 3/8 in
ASS 1 ENC 1

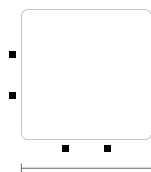

PUFF CTO
1,05 m x 1,05 m | 41 3/8 x 41 3/8 in

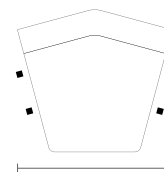

PUFF CURVO
1,25 m x 1,05 m | 49 2/8 x 41 3/8 in

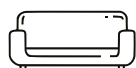

Cliff

SOFÁS
SOFÁS | SOFÁS

Assento fixo, com costura em pesponto duplo com detalhe composê aparente. Encosto fixo, com costura em pesponto duplo com detalhe composê aparente. Braço fixo, com costura em pesponto duplo com detalhe composê aparente. Almofada de assento fixa, com costura em pesponto duplo com detalhe composê aparente. Almofada de encosto solta, com costura em pesponto duplo com detalhe composê aparente. Almofada decorativa solta, sem detalhe de costura. Almofada cilíndrica maior solta, sem detalhe de costura, com 2cm de diâmetro. Almofada cilíndrica menor solta, sem detalhe de costura, com 8cm de diâmetro. Aparador em MDF, nos acabamentos laminado e laminado especial. Revisteiro em MDF, nos acabamentos laminado e laminado especial. Suporte pés em polipropileno injetado, na cor preta

Medidas podem apresentar leves variações. Nos reservamos o direito de efetuar alterações sem consulta prévia.

Seat: fixed, with double stitching with apparent composite detail.
Backrest: fixed, with double stitching with apparent composite detail.
Arm: fixed, with double topstitching with apparent composite detail.
Seat cushion: fixed, with double stitching with apparent composite detail.
Back cushion: loose, with double topstitching stitching with apparen composite detail, 50cm high.
Decorative cushion: loose, without seam detail, with 50x50cm.
Larger cylindrical cushion: loose, without seam detail, with 12cm in diameter.
Smaller cylindrical cushion: loose, without seam detail, with 8cm in diameter.
Sideboard: in MDF, in laminate and special laminate finishes.
Magazine rack: in MDF, in laminate and special laminate finishes.
Support: feet in injected polypropylene, in black color.

Measures may vary slightly. We reserve the right to make changes without prior consultation.

Asiento: fijo, con doble costura con detalle de composite aparente.
Respaldo: fijo, con doble costura con detalle de composite aparente.
Brazo: fijo, con doble pespunte con aparente detalle de composite.
Cojín del asiento: fijo, con doble costura con detalle de composite aparente.
Cojín del respaldo: suelto, con pespuntos dobles con detalle de composite aparente, de 50 cm de altura.
Cojín decorativo: suelto, sin detalle de costuras, con 50x50cm.
Cojín cilíndrico más grande: suelto, sin detalle de costuras, de 12cm de diámetro.
Cojín cilíndrico más pequeño: suelto, sin detalle de costuras, de 8cm de diámetro.
Aparador: en MDF, en laminado y acabados laminados especiales.
Revistero: en MDF, en laminado y acabados especiales laminados.
Soporte: pies en polipropileno inyectado, en color negro.

Las medidas pueden variar un poco. Nos reservamos el derecho de realizar cambios sin previa consulta.

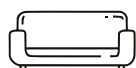

COBAIN

sofá articulado



ponto **vírgula**

COBAIN

sofá articulado

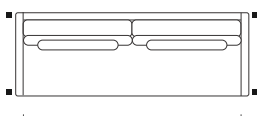
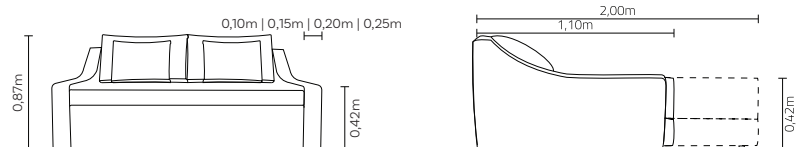

2B1	ASS	ENC	BRA	DEC
1,40 m	1	1	2	2
1,60 m	1	1	2	2
1,80 m	1	1	2	2

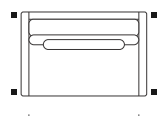

POL	ASS	ENC	BRA	DEC
0,90 x 1,10 m	1	1	2	1



Assento retrátil com abertura de 90cm sem detalhe de costura. Almofada de assento fixa com detalhes em matelassê. Encosto fixo com costura em pesponto simples. Almofada de encosto solta sem detalhe de costura. Braço fixo com costura em pesponto simples nas opções curvo ou reto. Almofada decorativa 70x50cm sem detalhe de costura. Pés em polipropileno injetado.

Retractable seat with 90cm opening, Fixed seat cushion. Fixed backrest. Loose back cushion. Fixed arm. Decorative pillow 70x50cm and injected polypropylene feet.

Asiento retráctil con apertura de 90 cm, Cojín de asiento fijo. Respaldo fijo. Cojín trasero suelto. Brazo fijo. Cojín decorativo de 70x50cm y pies de polipropileno inyectado.



Code



SOFÁS
SOFÁS | SOFÁS

ponto**vírgula**



Code

SOFÁS
SOFÁS | SOFÁS

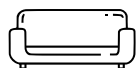

Code

SOFÁS
SOFÁS | SOFÁS

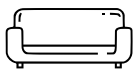
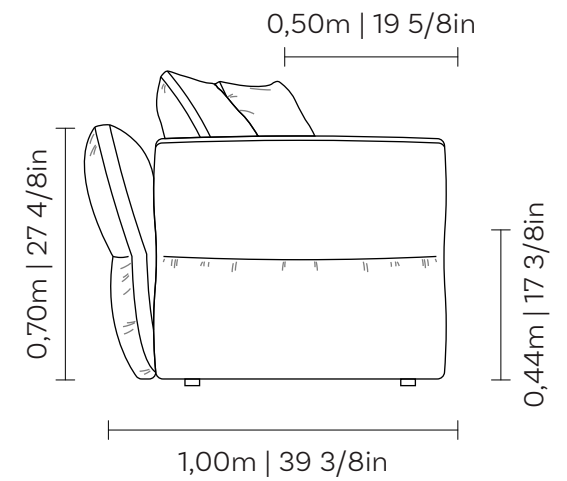
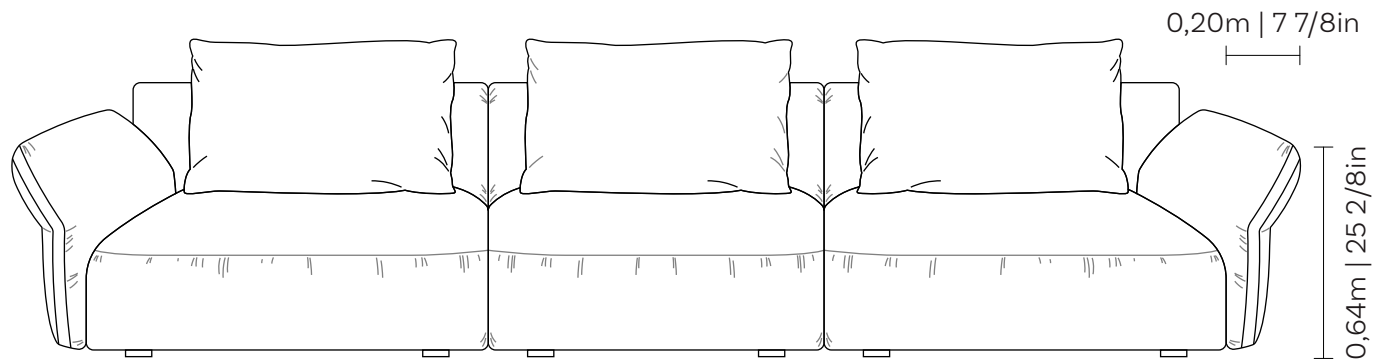

ponto**vírgula**

Code

SOFÁS
SOFÁS | SOFÁS

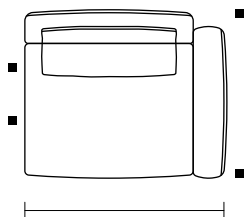

1B 1AS (D/E)	ASS	ENC
1,20 x 1,00 m 47 2/8 x 39 3/8 in	1	1
1,30 x 1,00 m 51 1/8 x 39 3/8 in	1	1
1,40 x 1,00 m 55 1/8 x 39 3/8 in	1	1
1,50 x 1,00 m 59 x 39 3/8 in	1	1

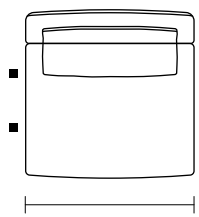

SB 1AS	ASS	ENC
1,00 x 1,00 m 39 3/8 x 39 3/8 in	1	1
1,10 x 1,00 m 43 2/8 x 39 3/8 in	1	1
1,20 x 1,00 m 47 2/8 x 39 3/8 in	1	1
1,30 x 1,00 m 51 1/8 x 39 3/8 in	1	1

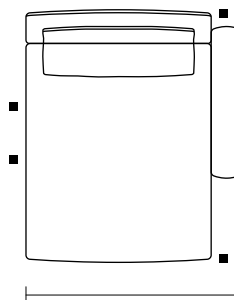

CH 1B (D/E)	ASS	ENC
1,20 x 1,50 m 47 2/8 x 59 in	1	1
1,30 x 1,50 m 51 1/8 x 59 in	1	1
1,40 x 1,50 m 55 1/8 x 59 in	1	1

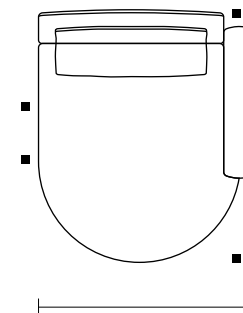

CH 1B REDONDA	ASS	ENC
1,30 x 1,50 m 51 1/8 x 59 in	1	1

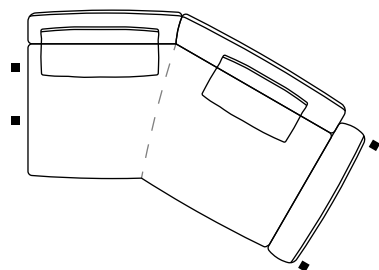

1B CURVO (D/E)	ASS	ENC
2,00 x 1,50 m 78 6/8 x 59 in	1	2

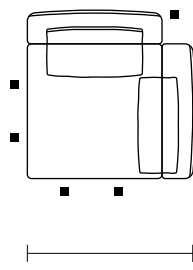

CTO	ASS	ENC
1,00 x 1,00 m 39 3/8 x 39 3/8 in	1	1

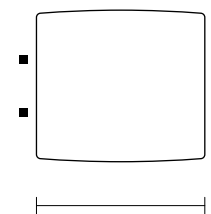

PUFF MEIO	ASS
1,00 x 0,90 m 39 3/8 x 35 3/8 in	1
1,10 x 0,90 m 43 2/8 x 35 3/8 in	1
1,20 x 0,90 m 47 2/8 x 35 3/8 in	1
1,30 x 0,90 m 51 1/8 x 35 3/8 in	1

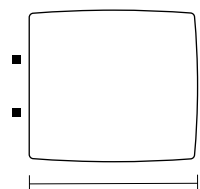

PUFF BI (D/E)	ASS
1,00 x 0,90 m 39 3/8 x 35 3/8 in	1
1,10 x 0,90 m 43 2/8 x 35 3/8 in	1
1,20 x 0,90 m 47 2/8 x 35 3/8 in	1
1,30 x 0,90 m 51 1/8 x 35 3/8 in	1

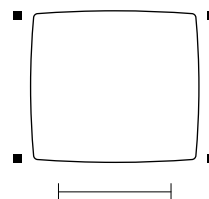

PUFF	ASS
1,00 x 0,70 m 39 3/8 x 27 4/8 in	1
1,10 x 0,70 m 43 2/8 x 27 4/8 in	1
1,20 x 0,70 m 47 2/8 x 27 4/8 in	1
1,30 x 0,70 m 51 1/8 x 27 4/8 in	1

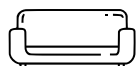

pontovírgula

Code

SOFÁS
SOFÁS | SOFÁS

Assento: fixo, sem detalhe de costura, com leve sobra de tecido.
Encosto: fixo, sem detalhe de costura, com leve sobra de tecido.
Braço: fixo, sem detalhe de costura, com leve sobra de tecido.
Almofada de encosto: Solta, sem detalhe de costura, com 55cm de altura.
Suporte: Pés em polipropileno injetado, na cor preta.

Medidas podem apresentar leves variações. Nos reservamos o direito de efetuar alterações sem consulta prévia.

Seat: fixed, no stitching details, with slight excess fabric.
Backrest: fixed, no stitching details, with slight excess fabric.
Armrest: fixed, no stitching details, with slight excess fabric.
Back cushion: loose, no stitching details, 55 cm in height.
Support: Injected polypropylene legs, in black color.

Measures may vary slightly. We reserve the right to make changes without prior consultation.
*For more information, see our Comfort Guide.

Asiento: fijo, sin detalles de costura, con ligero excedente de tela.
Respaldo: fijo, sin detalles de costura, con ligero excedente de tela.
Brazo: fijo, sin detalles de costura, con ligero excedente de tela.
Cojín de respaldo: suelto, sin detalles de costura, con 55 cm de altura.
Soporte: Patas de polipropileno inyectado, en color negro.

Las medidas pueden variar un poco. Nos reservamos el derecho de realizar cambios sin previa consulta.
*Para más informaciones, consulte nuestro Guía de Confort.

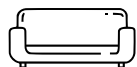

Corso



SOFÁS
SOFAS | SOFÁS

ponto**vírgula**



Corso

SOFÁS
SOFAS | SOFÁS

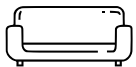

Corso

SOFÁS
SOFAS | SOFÁS

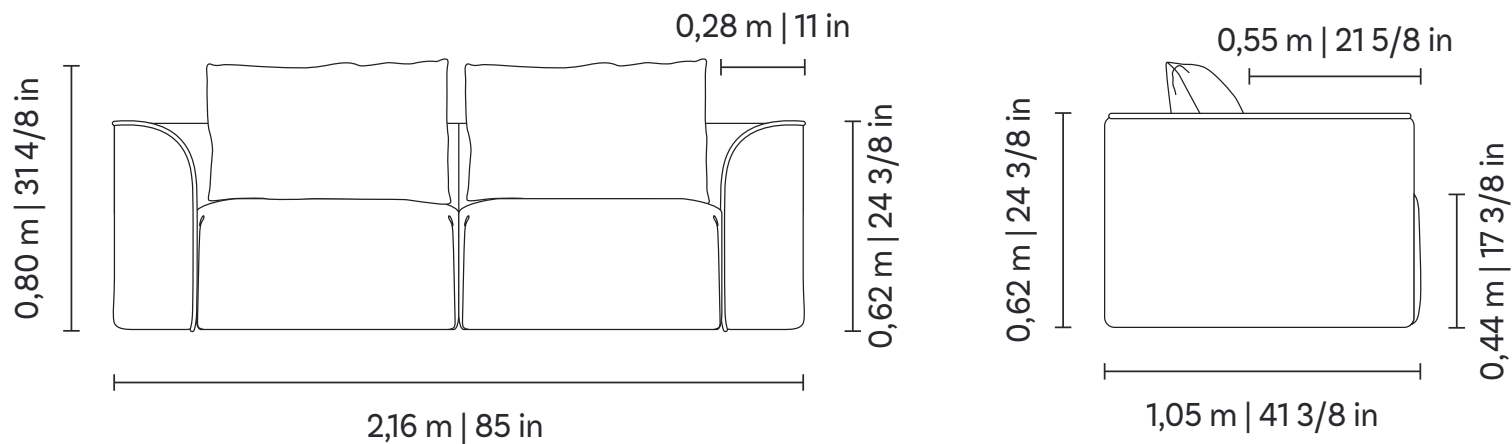

Assento fixo com sobras de tecido e sem detalhe de costura. Encosto e braço fixos, com sobras de tecido na área interna e com costura em debrum. Almofada de encosto solta, sem detalhe de costura. Pés em polipropileno injetado na cor preta.

Fixed seat with excess of fabric and without seam detail. Fixed backrest and armrest with excess of fabric. Loose backrest cushion without seam detail. Black injected polypropylene feet.

Asiento fijo con arrugas naturales de tejido y sin detalle de costura. Respaldo y brazos fijos con arrugas naturales de tejido. Cojín de respaldo suelto sin detalle de costura. Patas de polipropileno inyectado color negro.

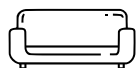

Corso

SOFÁS
SOFAS | SOFÁS

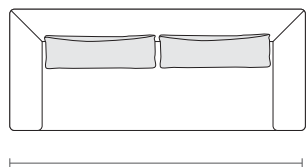

2B1	ASS	ENC
2,16 m 85 in	2	2
2,36 m 92 7/8 in	2	2
2,56 m 100 6/8 in	2	2
2,76 m 108 5/8 in	2	2
2,96 m 116 4/8 in	2	2
3,16 m 124 3/8 in	2	2

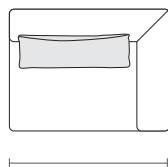

1B1 (D/E)	ASS	ENC
1,08 m 42 4/8 in	1	1
1,18 m 46 4/8 in	1	1
1,28 m 50 3/8 in	1	1
1,38 m 54 3/8 in	1	1
1,48 m 58 2/8 in	1	1
1,58 m 62 2/8 in	1	1

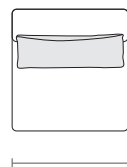

SB1	ASS	ENC
0,80 m 31 4/8 in	1	1
0,90 m 35 3/8 in	1	1
1,00 m 39 3/8 in	1	1
1,10 m 43 2/8 in	1	1
1,20 m 47 2/8 in	1	1
1,30 m 51 1/8 in	1	1

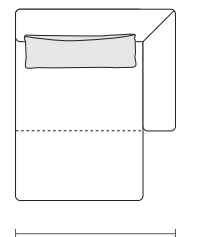

CH 1B (D/E)	ASS	ENC
1,08 X 1,65 m 42 4/8 x 65 in	1	1
1,18 X 1,65 m 46 4/8 x 65 in	1	1
1,28 X 1,65 m 50 3/8 x 65 in	1	1
1,38 X 1,65 m 54 3/8 x 65 in	1	1
1,48 X 1,65 m 58 2/8 x 65 in	1	1
1,58 X 1,65 m 62 2/8 x 65 in	1	1

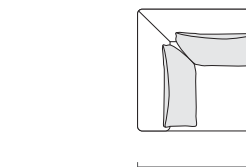

CTO (D/E)	ASS	ENC
1,05 x 1,05 m 41 3/8 x 41 3/8 in	1	2

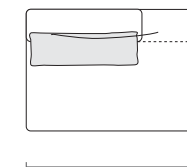

SBB1 (D/E)	ASS	ENC
1,30 m 51 1/8 in	1	1
1,40 m 55 1/8 in	1	1
1,50 m 59 in	1	1
1,60 m 63 in	1	1
1,70 m 66 7/8 in	1	1
1,80 m 70 7/8 in	1	1

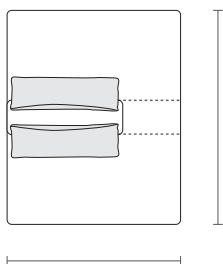

SBB1 / SBB1 (D/E)	ASS	ENC
1,30 x 1,85 m 51 1/8 x 72 7/8 in	2	2
1,40 x 1,85 m 55 1/8 x 72 7/8 in	2	2
1,50 x 1,85 m 59 x 72 7/8 in	2	2
1,60 x 1,85 m 63 x 72 7/8 in	2	2
1,70 x 1,85 m 66 7/8 x 72 7/8 in	2	2
1,80 x 1,85 m 70 7/8 x 72 7/8 in	2	2

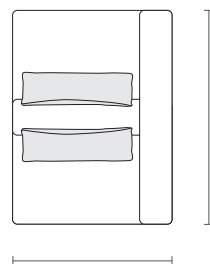

1B 1AS / 1B 1AS	ASS	ENC
1,08 x 1,85 m 42 4/8 x 72 7/8 in	2	2
1,18 x 1,85 m 46 4/8 x 72 7/8 in	2	2
1,28 x 1,85 m 50 3/8 x 72 7/8 in	2	2
1,38 x 1,85 m 54 3/8 x 72 7/8 in	2	2
1,48 x 1,85 m 58 2/8 x 72 7/8 in	2	2
1,58 x 1,85 m 62 2/8 x 72 7/8 in	2	2

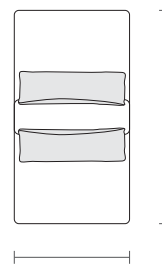

SB 1AS / SB 1AS	ASS	ENC
0,80 x 1,85 m 31 4/8 x 72 7/8 in	2	2
0,90 x 1,85 m 35 3/8 x 72 7/8 in	2	2
1,00 x 1,85 m 39 3/8 x 72 7/8 in	2	2
1,10 x 1,85 m 43 2/8 x 72 7/8 in	2	2
1,20 x 1,85 m 47 2/8 x 72 7/8 in	2	2
1,30 x 1,85 m 51 1/8 x 72 7/8 in	2	2

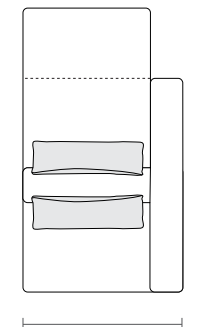

CH 1B 1AS / 1B 1AS	ASS	ENC
1,08 x 2,45 m 42 4/8 x 96 4/8 in	2	2
1,18 x 2,45 m 46 4/8 x 96 4/8 in	2	2
1,28 x 2,45 m 50 3/8 x 96 4/8 in	2	2
1,38 x 2,45 m 54 3/8 x 96 4/8 in	2	2
1,48 x 2,45 m 58 2/8 x 96 4/8 in	2	2
1,58 x 2,45 m 62 2/8 x 96 4/8 in	2	2

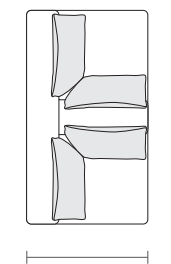

CTO / CTO	ASS	ENC
1,05 x 1,85 m 41 3/8 x 72 7/8 in	2	4

Cromie



SOFÁS
SOFÁS | SOFÁS

pontovírgula



Cromie

SOFÁS
SOFÁS | SOFÁS

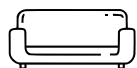

Cromie

SOFÁS
SOFÁS | SOFÁS

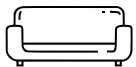
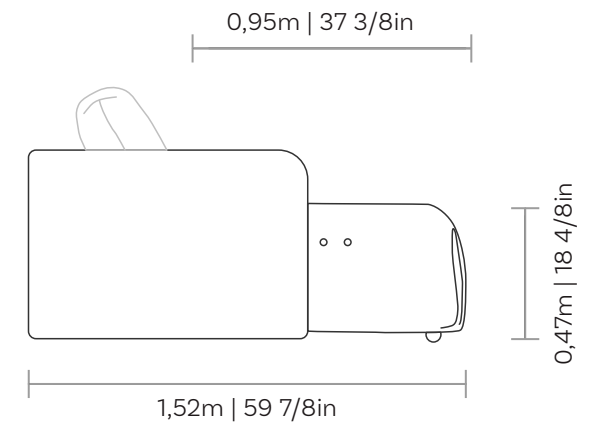
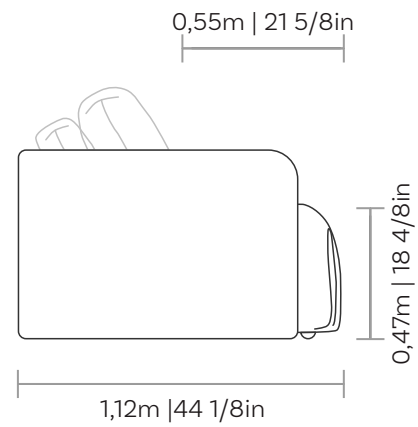
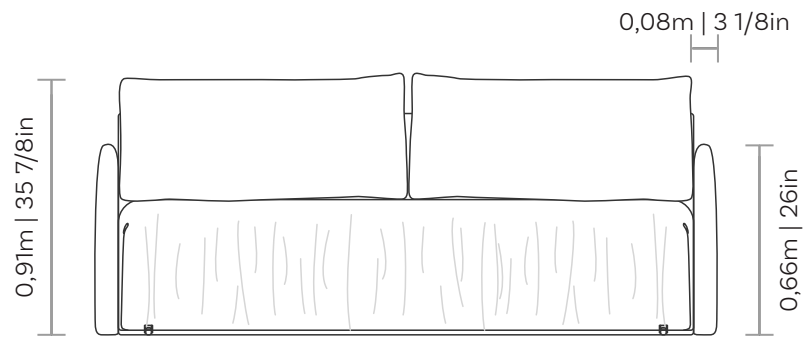

Cromie

SOFÁS
SOFÁS | SOFÁS

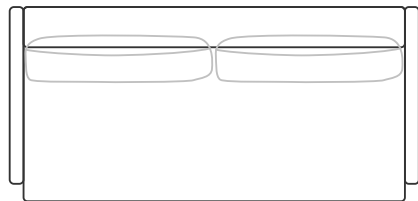

2B 1AS (MOTOR)	ASS	DEC
1,60 x 1,12 m 63 x 44 1/8 in	1	2
1,80 x 1,12 m 70 7/8 x 44 1/8 in	1	2
2,00 x 1,12 m 78 6/8 x 44 1/8 in	1	2
2,20 x 1,12 m 86 5/8 x 44 1/8 in	1	2

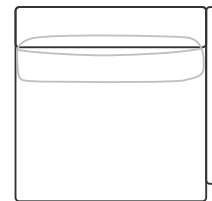

1B 1AS (MANUAL E MOTOR)	ASS	ENC
0,80 x 1,12 m 31 4/8 x 44 1/8 in	1	1
0,90 x 1,12 m 35 3/8 x 44 1/8 in	1	1
1,00 x 1,12 m 39 3/8 x 44 1/8 in	1	1
1,10 x 1,12 m 43 2/8 x 44 1/8 in	1	1
1,20 x 1,12 m 47 2/8 x 44 1/8 in	1	1
1,30 x 1,12 m 51 1/8 x 44 1/8 in	1	1
1,40 x 1,12 m 55 1/8 x 44 1/8 in	1	1

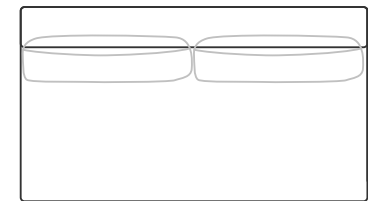

1B 1AS (MOTOR)	ASS	ENC
1,60 x 1,12 m 63 x 44 1/8 in	1	2
1,80 x 1,12 m 70 7/8 x 44 1/8 in	1	2
2,00 x 1,12 m 78 6/8 x 44 1/8 in	1	2
2,20 x 1,12 m 86 5/8 x 44 1/8 in	1	2

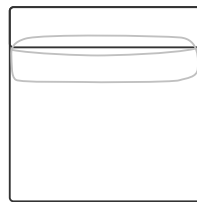

SB 1AS (MANUAL E MOTOR)	ASS	ENC
0,80 x 1,12 m 31 4/8 x 44 1/8 in	1	1
0,90 x 1,12 m 35 3/8 x 44 1/8 in	1	1
1,00 x 1,12 m 39 3/8 x 44 1/8 in	1	1
1,10 x 1,12 m 43 2/8 x 44 1/8 in	1	1
1,20 x 1,12 m 47 2/8 x 44 1/8 in	1	1
1,30 x 1,12 m 51 1/8 x 44 1/8 in	1	1
1,40 x 1,12 m 55 1/8 x 44 1/8 in	1	1

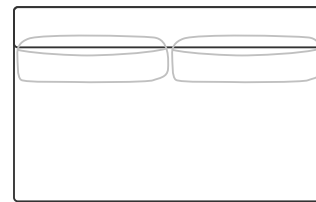

SB 1AS (MOTOR)	ASS	ENC
1,60 x 1,12 m 63 x 44 1/8 in	1	2
1,80 x 1,12 m 70 7/8 x 44 1/8 in	1	2
2,00 x 1,12 m 78 6/8 x 44 1/8 in	1	2
2,20 x 1,12 m 86 5/8 x 44 1/8 in	1	2



PUFF	ASS
0,80 x 0,70 m 31 4/8 x 27 4/8 in	1
0,90 x 0,70 m 35 3/8 x 27 4/8 in	1
1,00 x 0,70 m 39 3/8 x 27 4/8 in	1
1,10 x 0,70 m 43 2/8 x 27 4/8 in	1
1,20 x 0,70 m 47 2/8 x 27 4/8 in	1
1,30 x 0,70 m 51 1/8 x 27 4/8 in	1
1,40 x 0,70 m 55 1/8 x 27 4/8 in	1
1,60 x 0,70 m 63 x 27 4/8 in	1
1,80 x 0,70 m 70 7/8 x 27 4/8 in	1
2,00 x 0,70 m 78 6/8 x 27 4/8 in	1
2,20 x 0,70 m 86 5/8 x 27 4/8 in	1

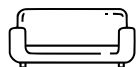

Cromie

SOFÁS
SOFÁS | SOFÁS

Assento: retrátil com abertura de 40 cm e opção de motor ou articulado simplificado, sem detalhe de costura.

Encosto: reclinável, com costura em pesponto simples.

Braço: fixo, com costura em pesponto simples e pesponto duplo.

Pés: polipropileno injetado na cor preta.

Medidas podem apresentar leves variações. Nos reservamos o direito de efetuar alterações sem consulta prévia.

Seat: retractable with 40 cm opening and option of motor or simplified articulated, without seam detail.

Backrest: reclining, with simple backstitch.

Arm: fixed, with single backstitch and double backstitch.

Feet: injected polypropylene in black color.

Measures may vary slightly. We reserve the right to make changes without prior consultation.

*For more information, see our Comfort Guide.

Asiento: retráctil con abertura de 40 cm y opción de motor o articulado simplificado, sin detalle de costuras.

Respaldo: reclinable, con pespunte simples.

Braço: fijo, con pespuntos simples y doble pespuntos.

Patas: polipropileno inyectado en color negro.

Las medidas pueden variar un poco. Nos reservamos el derecho de realizar cambios sin previa consulta.

*Para más informaciones, consulte nuestro Guía de Comfort.

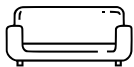

ponto**vírgula**

DOM

sofá articulado



ponto **vírgula**

DOM

sofá articulado



•pv

DOM

sofá articulado

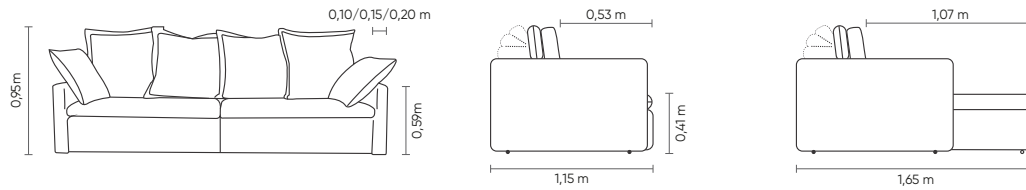

1B1 (D/E)	ASS	BRA	DEC	SB 1	ASS	DEC	CTO	ASS	DEC	CH 1B (D/E)	ASS	BRA	DEC	SBBI (D/E)	ASS	DEC
0,70 m	1	1	2	0,70 m	1	2	1,15 x 1,15 m	1	3	0,70 x 1,65 m	1	1	2	1,30 x 1,15 m	1	2
0,80 m	1	1	2	0,80 m	1	2				0,80 x 1,65 m	1	1	2	1,40 x 1,15 m	1	2
0,90 m	1	1	2	0,90 m	1	2				0,90 x 1,65 m	1	1	2	1,50 x 1,15 m	1	2
1,00 m	1	1	2	1,00 m	1	2				1,00 x 1,65 m	1	1	2	1,60 x 1,15 m	1	2
1,10 m	1	1	2	1,10 m	1	2				1,10 x 1,65 m	1	1	2	1,70 x 1,15 m	1	2
1,20 m	1	1	2	1,20 m	1	2				1,20 x 1,65 m	1	1	2	1,80 x 1,15 m	1	2

Pés em polipropileno injetado na cor preta. Assento retrátil com abertura de 50cm. Almofada fixa com costura em pesponto simples e detalhes em ponto puxado, almofada solta 60x60cm costurada com fole 4,0cm e decorativa 70x70cm costurada com fole 4,0cm. Encosto reclinável com costura em pesponto simples. Braço fixo com costura em pesponto simples e opção de escolha de largura. Opção de CTO com ou sem catraca de encosto.

Retractable seating with 50cm opening. Reclining backrest and option to choose arm width. 75x75cm Backrest cushions and 65x65cm decorative cushions. Black injected polypropylene feet. Option of corner with or without backrest recliner mechanism.

Asiento retráctil con apertura de 50cm. Respaldo reclinable y opción para elegir el ancho de los brazos. Cojines de respaldo 75x75cm y cojines decorativos 65x65cm. Patas de polipropileno inyectado color negro. Opción de canto con o sin mecanismo de respaldo reclinable.

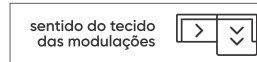

Ellie



SOFÁS
SOFAS | SOFÁS

pontovírgula



Ellie

SOFÁS
SOFÁS | SOFÁS

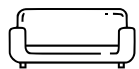

pontovírgula

Ellie

SOFÁS
SOFÁS | SOFÁS

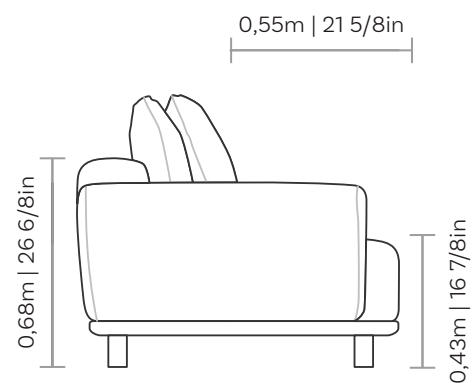
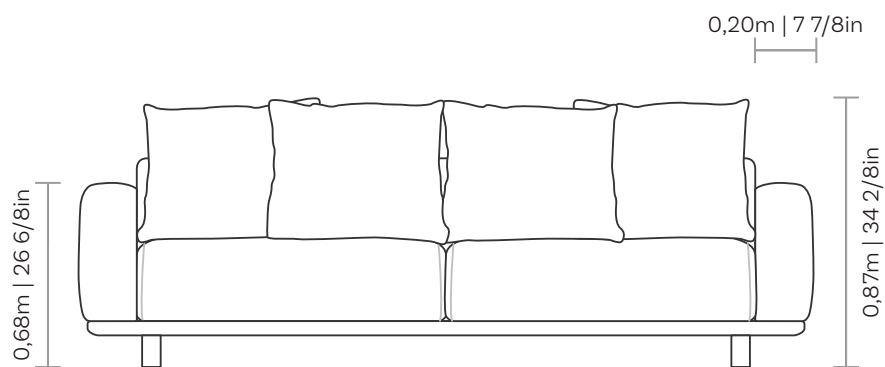

1,05m | 41 3/8in
profundidade total do sentar (fechado)

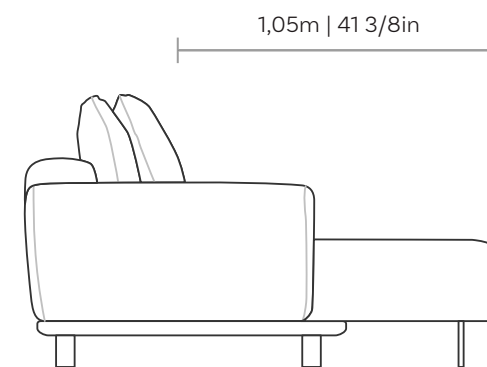

1,40m | 61in
profundidade total do sentar (aberto)

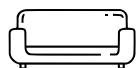
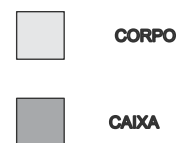
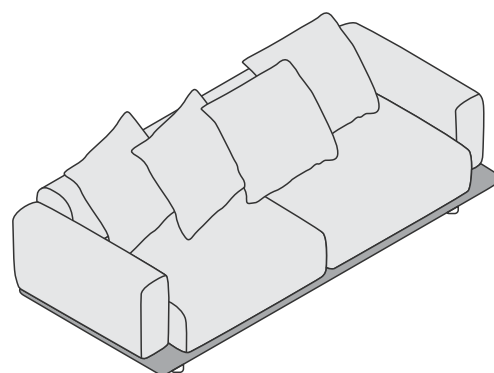

Ellie

SOFÁS
SOFÁS | SOFÁS

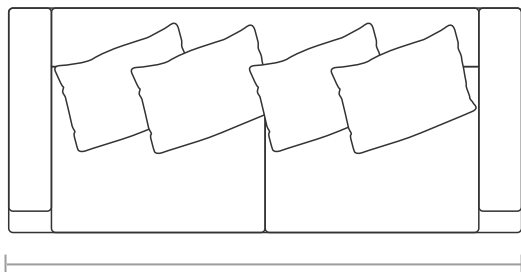

2B 2AS	ASS	DEC
2,00 x 1,05 m 78 6/8 x 41 3/8 in	2	4
2,20 x 1,05 m 86 5/8 x 41 3/8 in	2	4
2,40 x 1,05 m 94 4/8 x 41 3/8 in	2	4
2,60 x 1,05 m 102 3/8 x 41 3/8 in	2	4
2,80 x 1,05 m 110 2/8 x 41 3/8 in	2	4

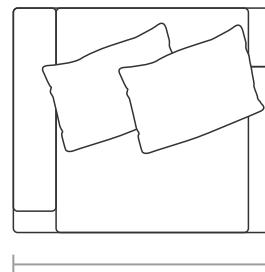

1B 1AS	ASS	DEC
1,00 x 1,05 m 39 3/8 x 41 3/8 in	1	2
1,10 x 1,05 m 43 2/8 x 41 3/8 in	1	2
1,20 x 1,05 m 47 2/8 x 41 3/8 in	1	2
1,30 x 1,05 m 51 1/8 x 41 3/8 in	1	2
1,40 x 1,05 m 55 1/8 x 41 3/8 in	1	2

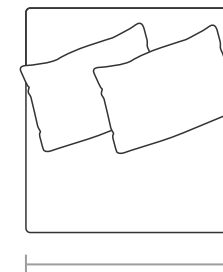

SB 1AS	ASS	DEC
0,80 x 1,05 m 31 4/8 x 41 3/8 in	1	1
0,90 x 1,05 m 35 3/8 x 41 3/8 in	1	1
1,00 x 1,05 m 39 3/8 x 41 3/8 in	1	2
1,10 x 1,05 m 43 2/8 x 41 3/8 in	1	2
1,20 x 1,05 m 47 2/8 x 41 3/8 in	1	2

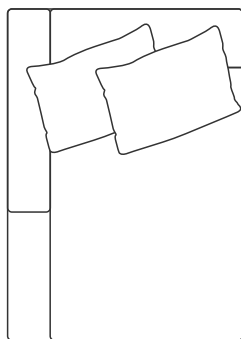

CH 1B	ASS	DEC
1,00 x 1,55 m 39 3/8 x 61 in	1	2
1,10 x 1,55 m 43 2/8 x 61 in	1	2
1,20 x 1,55 m 47 2/8 x 61 in	1	2
1,30 x 1,55 m 51 1/8 x 61 in	1	2
1,40 x 1,55 m 55 1/8 x 61 in	1	2

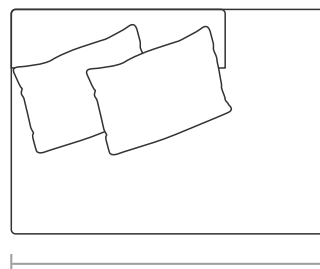

SB BI	ASS	DEC
1,30 x 1,05 m 51 1/8 x 41 3/8 in	1	1
1,40 x 1,05 m 55 1/8 x 41 3/8 in	1	1
1,50 x 1,05 m 59 x 41 3/8 in	1	2
1,60 x 1,05 m 63 x 41 3/8 in	1	2
1,70 x 1,05 m 66 7/8 x 41 3/8 in	1	2

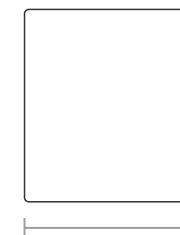

PUFF	ASS
0,60 x 0,90 m 23 5/8 x 35 3/8 in	1
0,70 x 0,90 m 27 4/8 x 43 3/8 in	1
0,80 x 0,90 m 31 4/8 x 35 3/8 in	1
0,90 x 0,90 m 35 3/8 x 35 3/8 in	1

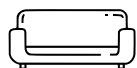

Ellie

SOFÁS
SOFÁS | SOFÁS

Assento: retrátil com abertura de 35cm e opção de motor ou manual, com costura em pesponto simples.

Encosto: fixo, com costura em pesponto simples.

Braço: fixo, com costura em pesponto simples.

Suporte: Pés em aço carbono, disponível nos acabamentos MTX, pintura fosca e pintura metalizada e pés de apoio, quando o assento está aberto, em aço carbono no acabamento MTX na cor preta.

Almofada decorativa: solta, com 75x65cm, sem detalhe de costura.

Medidas podem apresentar leves variações. Nos reservamos o direito de efetuar alterações sem consulta prévia.

Seat: retractable with 35cm opening and option of motor or manual, with simple stitching.

Backrest: fixed, with simple stitching.

Armrest: fixed, with simple stitching.

Support: carbon steel feet, available in MTX finishes, matte paint and metallic paint and support feet, when the seat is open, in carbon steel in MTX finish in black color.

Decorative cushion: loose, with 75x65 cm, without seam detail.

Measures may vary slightly. We reserve the right to make changes without prior consultation.

*For more information, see our Comfort Guide.

Asiento: retráctil con apertura de 35cm y opción de motor o manual, con costuras simples.

Respaldo: fijo, con costuras simples.

Brazo: fijo, con costuras simples.

Soporte: Patas de acero al carbono, disponibles en acabados MTX, pintura mate y pintura metalizada y patas de apoyo, cuando el asiento está abierto, en acero al carbono en acabado MTX en color negro.

Cojín Decorativo: suelto, de 75x65cm, sin detalle de costuras.

Las medidas pueden variar un poco. Nos reservamos el derecho de realizar cambios sin previa consulta.

*Para más informaciones, consulte nuestro Guía de Confort.

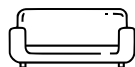

ponto**vírgula**

Eterium



SOFÁS
SOFAS | SOFÁS

ponto**vírgula**



Eterium

SOFÁS
SOFAS | SOFÁS

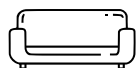

Eterium

SOFÁS
SOFAS | SOFÁS

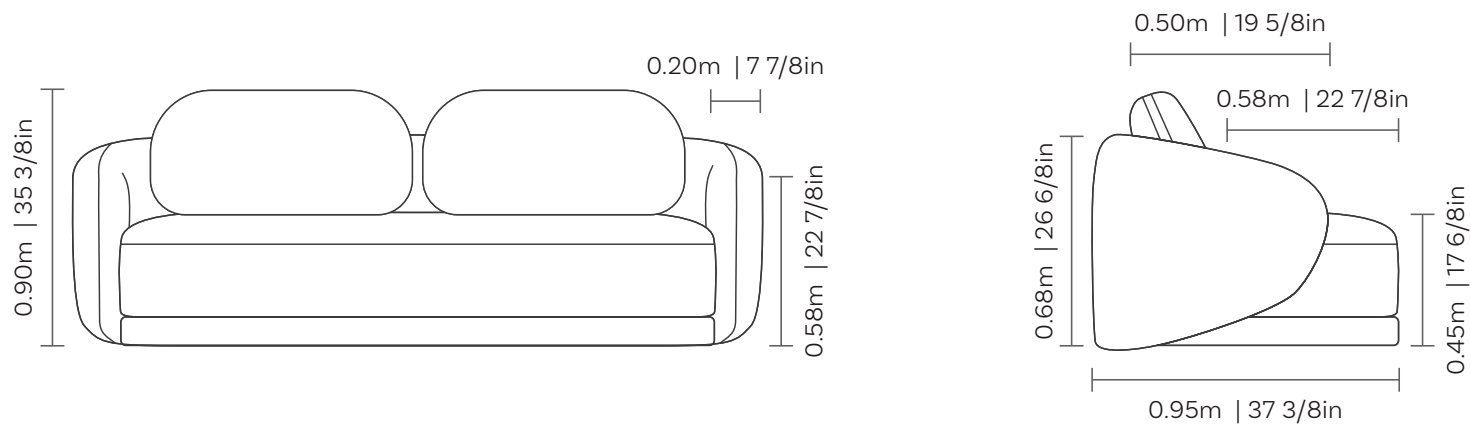

Assento e encosto fixos, com costura em pesponto duplo. Braços fixos com costura em pesponto simples. Almofada de encosto solta com costura em pesponto simples. Pés em polipropileno injetado na cor preta. Aparador disponível nos acabamentos pintura laca, laca metalizado, laminado e mármore.

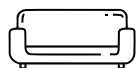

Eterium

SOFÁS
SOFAS | SOFÁS



2 BRAÇOS 1 ASSENTO

DIMENSÕES		ENCOSTO	
DIMENSIONS DIMENSIONES	BACKREST RESPALDO	DIMENSIONS DIMENSIONES	BACKREST RESPALDO
2.00m x 0.95m 78 6/8in x 37 3/8in	2		
2.20m x 0.95m 86 5/8in x 37 3/8in	2		
2.40m x 0.95m 94 4/8in x 37 3/8in	2		
2.60m x 0.95m 102 3/8in x 37 3/8in	2		
2.80m x 0.95m 110 2/8in x 37 3/8in	2		
3.00m x 0.95m 118 1/8in x 37 3/8in	2		
3.20m x 0.95m 126in x 37 3/8in	2		



1 BRAÇO 1 ASSENTO

DIMENSÕES		ENCOSTO	
DIMENSIONS DIMENSIONES	BACKREST RESPALDO	DIMENSIONS DIMENSIONES	BACKREST RESPALDO
1.00m x 0.95m 39 3/8in x 37 3/8in	1		
1.10m x 0.95m 43 2/8in x 37 3/8in	1		
1.20m x 0.95m 47 2/8in x 37 3/8in	1		
1.30m x 0.95m 51 1/8in x 37 3/8in	1		
1.40m x 0.95m 55 1/8in x 37 3/8in	1		
1.50m x 0.95m 59in x 37 3/8in	1		
1.60m x 0.95m 63in x 37 3/8in	1		



SEM BRAÇO 1 ASSENTO

DIMENSÕES		ENCOSTO	
DIMENSIONS DIMENSIONES	BACKREST RESPALDO	DIMENSIONS DIMENSIONES	BACKREST RESPALDO
0.80m x 0.95m 31 4/8in x 37 3/8in	1		
0.90m x 0.95m 35 3/8in x 37 3/8in	1		
1.00m x 0.95m 39 3/8in x 37 3/8in	1		
1.10m x 0.95m 43 2/8in x 37 3/8in	1		
1.20m x 0.95m 47 2/8in x 37 3/8in	1		
1.30m x 0.95m 51 1/8in x 37 3/8in	1		

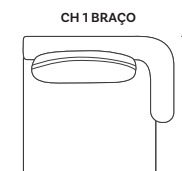

CH 1 BRAÇO

DIMENSÕES		ENCOSTO	
DIMENSIONS DIMENSIONES	BACKREST RESPALDO	DIMENSIONS DIMENSIONES	BACKREST RESPALDO
1.00m x 1.55m 39 3/8in x 61in	1		
1.10m x 1.55m 43 2/8in x 61in	1		
1.20m x 1.55m 47 2/8in x 61in	1		
1.30m x 1.55m 51 1/8in x 61in	1		
1.40m x 1.55m 55 1/8in x 61in	1		
1.50m x 1.55m 59in x 61in	1		
1.60m x 1.55m 63in x 61in	1		

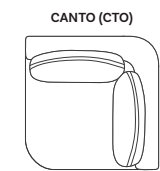

CANTO (CTO)

DIMENSÕES		ENCOSTO	
DIMENSIONS DIMENSIONES	BACKREST RESPALDO	DIMENSIONS DIMENSIONES	BACKREST RESPALDO
1.15m x 1.15m 45 2/8in x 45 2/8in	2		



PUFF 45°

DIMENSÕES
DIMENSIONS DIMENSIONES
0.85m x 0.95m 33 4/8in x 37 3/8in

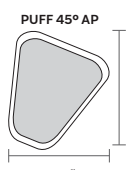

PUFF 45° AP

DIMENSÕES
DIMENSIONS DIMENSIONES
0.85m x 0.95m 33 4/8in x 37 3/8in

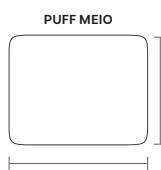

PUFF MEIO

DIMENSÕES
DIMENSIONS DIMENSIONES
0.80m x 0.95m 31 4/8in x 37 3/8in
0.90m x 0.95m 35 3/8in x 37 3/8in
1.00m x 0.95m 39 3/8in x 37 3/8in
1.10m x 0.95m 43 2/8in x 37 3/8in
1.20m x 0.95m 47 2/8in x 37 3/8in
1.30m x 0.95m 51 1/8in x 37 3/8in

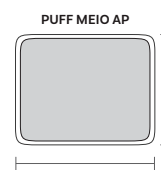

PUFF MEIO AP

DIMENSÕES
DIMENSIONS DIMENSIONES
0.80m x 0.95m 31 4/8in x 37 3/8in
0.90m x 0.95m 35 3/8in x 37 3/8in
1.00m x 0.95m 39 3/8in x 37 3/8in
1.10m x 0.95m 43 2/8in x 37 3/8in
1.20m x 0.95m 47 2/8in x 37 3/8in
1.30m x 0.95m 51 1/8in x 37 3/8in

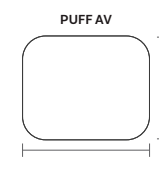

PUFF AV

DIMENSÕES
DIMENSIONS DIMENSIONES
1.10m x 0.90m 43 2/8in x 35 3/8in

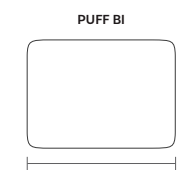

PUFF BI

DIMENSÕES
DIMENSIONS DIMENSIONES
0.80m x 0.95m 31 4/8in x 37 3/8in
0.90m x 0.95m 35 3/8in x 37 3/8in
1.00m x 0.95m 39 3/8in x 37 3/8in
1.10m x 0.95m 43 2/8in x 37 3/8in
1.20m x 0.95m 47 2/8in x 37 3/8in
1.30m x 0.95m 51 1/8in x 37 3/8in

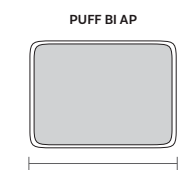

PUFF BI AP

DIMENSÕES
DIMENSIONS DIMENSIONES
0.80m x 0.95m 31 4/8in x 37 3/8in
0.90m x 0.95m 35 3/8in x 37 3/8in
1.00m x 0.95m 39 3/8in x 37 3/8in
1.10m x 0.95m 43 2/8in x 37 3/8in
1.20m x 0.95m 47 2/8in x 37 3/8in
1.30m x 0.95m 51 1/8in x 37 3/8in

Finn



SOFÁS
SOFÁS | SOFÁS

ponto**vírgula**



Finn

SOFÁS
SOFÁS | SOFÁS

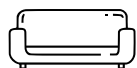

pontovirgula

Finn

SOFÁS
SOFÁS | SOFÁS

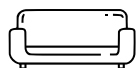
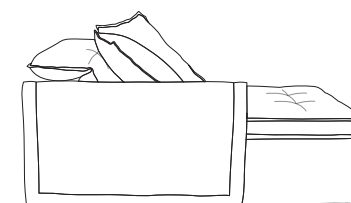
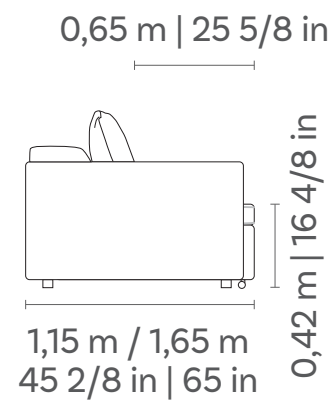
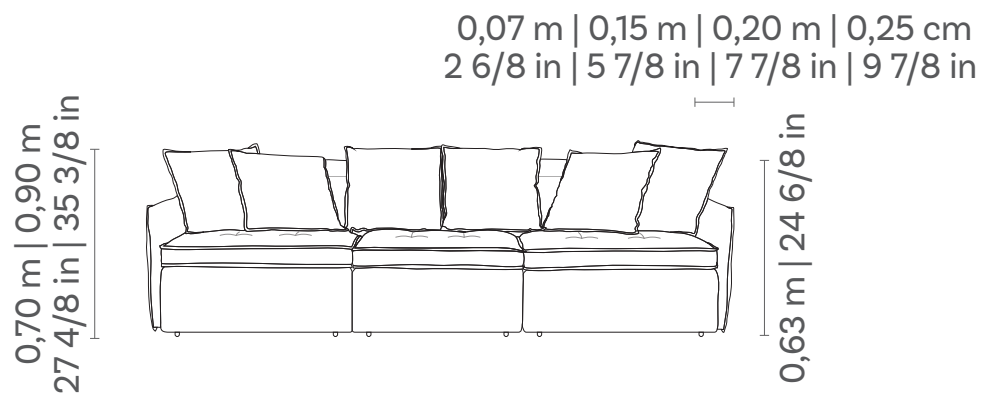

Finn

SOFÁS
SOFÁS | SOFÁS

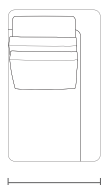

1B1 (D/E)	ASS	DEC	ENC
0,70 m 27 4/8 in	1	2	1
0,80 m 31 4/8 in	1	2	1
0,90 m 35 3/8 in	1	2	1
1,00 m 39 3/8 in	1	3	1
1,10 m 43 2/8 in	1	3	1
1,20 m 47 2/8 in	1	3	1

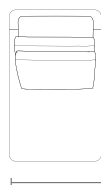

SB1 (D/E)	ASS	DEC	ENC
0,70 m 27 4/8 in	1	2	1
0,80 m 31 4/8 in	1	2	1
0,90 m 35 3/8 in	1	2	1
1,00 m 39 3/8 in	1	3	1
1,10 m 43 2/8 in	1	3	1
1,20 m 47 2/8 in	1	3	1

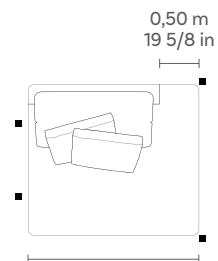

SBBI	ASS	DEC	ENC
1,30 x 1,15 m 51 1/8 x 45 2/8 in	1	2	1
1,40 x 1,15 m 55 1/8 x 45 2/8 in	1	2	1
1,50 x 1,15 m 59 x 45 2/8 in	1	2	1
1,60 x 1,15 m 63 x 45 2/8 in	1	3	1
1,70 x 1,15 m 66 7/8 x 45 2/8 in	1	3	1

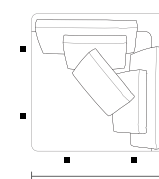

CTO	ASS	DEC	ENC
1,15 x 1,15 m 45 2/8 x 45 2/8 in	1	3	2

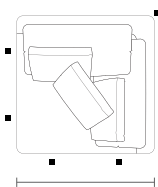

CTO COM CATRACA	ASS	DEC	ENC
1,15 x 1,15 m 45 2/8 x 45 2/8 in	1	3	2

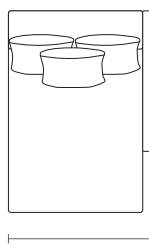

CH1B (D/E)	ASS	DEC	ENC
0,70 x 1,65 m 27 4/8 x 65 in	1	2	1
0,80 x 1,65 m 31 4/8 x 65 in	1	2	1
0,90 x 1,65 m 35 3/8 x 65 in	1	2	1
1,00 x 1,65 m 39 3/8 x 65 in	1	3	1
1,10 x 1,65 m 43 2/8 x 65 in	1	3	1
1,20 x 1,65 m 47 2/8 x 65 in	1	3	1



PUFF
0,70 x 1,15 m 27 4/8 x 45 2/8 in
0,80 x 1,15 m 31 4/8 x 45 2/8 in
0,90 x 1,15 m 35 3/8 x 45 2/8 in
1,00 x 1,15 m 39 3/8 x 45 2/8 in
1,10 x 1,15 m 43 2/8 x 45 2/8 in
1,20 x 1,15 m 47 2/8 x 45 2/8 in

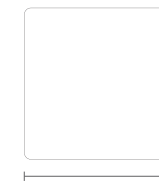

PUFF CTO
1,15 x 1,15 m 45 2/8 x 45 2/8 in

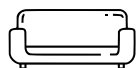

Finn

SOFÁS
SOFÁS | SOFÁS

Assento articulado com abertura de 50cm e opção de motor ou articulado simplificado. Encosto reclinável com costura em fole 1,5cm e detalhes em ponto puxado. Braços com costura em fole 1,5cm. Almofada de assento fixo com costura em fole 1,5cm e detalhes em ponto puxado e opção de escolha almofada decorativa 55x55cm ou lombar 40cm de altura. Pés em polipropileno injetado e rodízios em aço carbono com rodas de polipropileno.

Medidas podem apresentar leves variações. Nos reservamos o direito de efetuar alterações sem consulta prévia.

Articulated seat with 50cm opening and simplified engine or articulated option. Reclining backrest in 1.5cm bellows and details in pulled stitch. Arms in 1.5 cm bellows. Seat cushion fixed in 1.5 cm bellows and details in pulled point and choice of decorative pillow 55x55cm or lumbar 40cm high. Injected polypropylene feet and castors in carbon steel with polypropylene wheels.

Measures may vary slightly. We reserve the right to make changes without prior consultation.
*For more information, see our Comfort Guide.

Asiento articulado con apertura de 50cm y motor simplificado o opción articulada. Respaldo reclinable en fuelle de 1,5cm y detalles en respunte. Brazos en fuelle de 1,5 cm. Cojín de asiento fijo en fuelle de 1,5 cm y detalles en punto tirado y elección de almohada decorativa 55x55cm o lumbar 40cm de altura. Pies de polipropileno inyectado y ruedas de acero al carbono con ruedas de polipropileno.

Las medidas pueden variar un poco. Nos reservamos el derecho de realizar cambios sin previa consulta.
*Para más informaciones, consulte nuestro Guía de Confort.

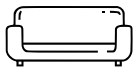

ponto**virgula**

Fiume



SOFÁS
SOFAS | SOFÁS

ponto**vírgula**



Fiume

SOFÁS
SOFAS | SOFÁS

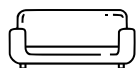

Fiume

SOFÁS
SOFAS | SOFÁS

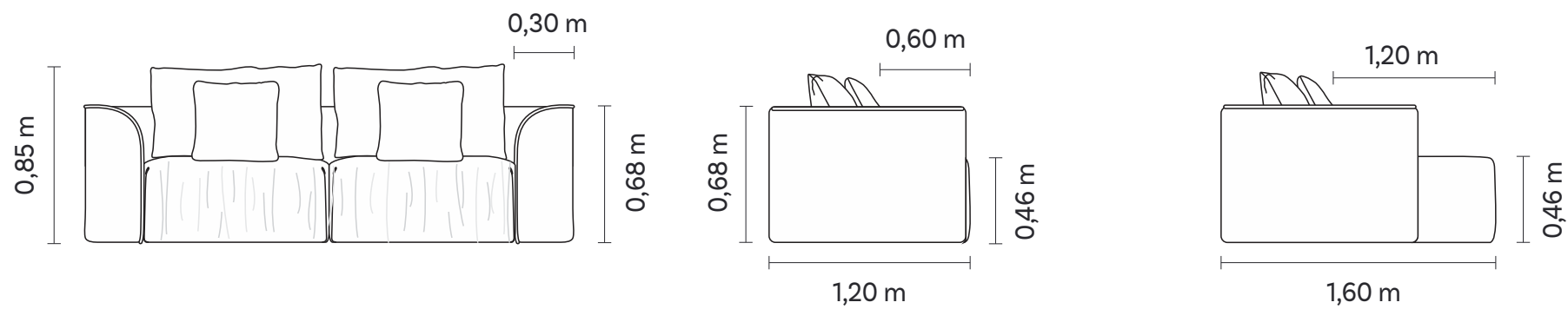

Assento retrátil, com abertura de 40 cm, com sobra de tecido e sem detalhe de costura. Encosto e braço fixos com sobra de tecido e costura em debrum composê. Almofada de encosto solta, sem detalhe de costura e almofada decorativa solta, sem detalhe de costura. Pés em polipropileno injetado na cor preta.

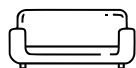

Fiume

SOFÁS
SOFAS | SOFÁS

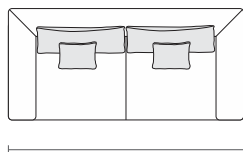

2B2	ASS	ENC	DEC
2,20 m	2	2	2
2,40 m	2	2	2
2,60 m	2	2	2
2,80 m	2	2	2
3,00 m	2	2	2

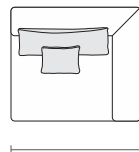

1B1 (D/E)	ASS	ENC	DEC
1,10 m	1	1	1
1,20 m	1	1	1
1,30 m	1	1	1
1,40 m	1	1	1
1,50 m	1	1	1

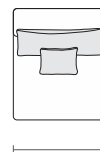

SB1	ASS	ENC	DEC
0,80 m	1	1	1
0,90 m	1	1	1
1,00 m	1	1	1
1,10 m	1	1	1
1,20 m	1	1	1

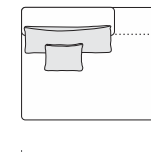

SBB1 (D/E)	ASS	ENC	DEC
1,30 m	1	1	1
1,40 m	1	1	1
1,50 m	1	1	1
1,60 m	1	1	1
1,70 m	1	1	1

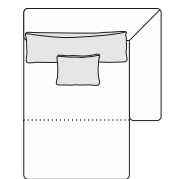

CH 1B (D/E)	ASS	ENC	DEC
1,10 X 1,60 m	1	1	1
1,20 X 1,60 m	1	1	1
1,30 X 1,60 m	1	1	1
1,40 X 1,60 m	1	1	1
1,50 X 1,60 m	1	1	1

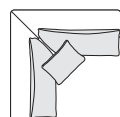

CTO (D/E)	ASS	ENC	DEC
1,20 x 1,20 m	1	2	1

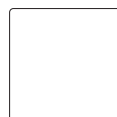

PUFF CTO	ASS
1,20 x 1,20 m	1

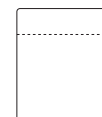

PUFF MEIO	ASS
0,80 x 1,20 m	1
0,90 x 1,20 m	1
1,00 x 1,20 m	1
1,10 x 1,20 m	1
1,20 x 1,20 m	1

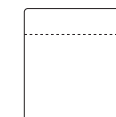

PUFF BI	ASS
0,80 x 1,20 m	1
0,90 x 1,20 m	1
1,00 x 1,20 m	1
1,10 x 1,20 m	1
1,20 x 1,20 m	1

FLOW

sofá articulado



ponto **vírgula**

FLOW

sofá articulado

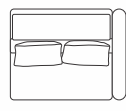
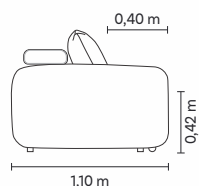
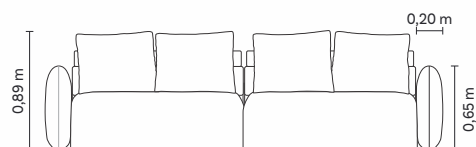

1B1 (D/E)	ASS	DEC
0,65 m	1	2
0,75 m	1	2
0,85 m	1	2
0,95 m	1	2
1,05 m	1	2
1,15 m	1	2

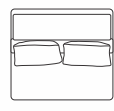

SB1	ASS	DEC
0,65 m	1	2
0,75 m	1	2
0,85 m	1	2
0,95 m	1	2
1,05 m	1	2
1,15 m	1	2

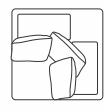

CTO (D/E)	ASS	DEC
1,10 x 1,10 m	1	3

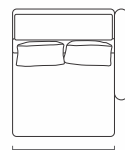

CH 1B (D/E)	ASS	DEC
0,65 x 1,60 m	1	2
0,75 x 1,60 m	1	2
0,85 x 1,60 m	1	2
0,95 x 1,60 m	1	2
1,05 x 1,60 m	1	2
1,15 x 1,60 m	1	2

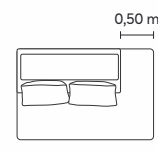

SB BI (D/E)	ASS	DEC
1,15 m	1	2
1,25 m	1	2
1,35 m	1	2
1,45 m	1	2
1,55 m	1	2
1,65 m	1	2



PUFF
0,65 x 0,50 m
0,75 x 0,50 m
0,85 x 0,50 m
0,95 x 0,50 m
1,05 x 0,50 m
1,15 x 0,50 m

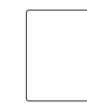

PUFF MEIO
0,65 x 1,10 m
0,75 x 1,10 m
0,85 x 1,10 m
0,95 x 1,10 m
1,05 x 1,10 m
1,15 x 1,10 m



PUFF BI
0,65 x 1,10 m
0,75 x 1,10 m
0,85 x 1,10 m
0,95 x 1,10 m
1,05 x 1,10 m
1,15 x 1,10 m

Assento retrátil costurado em pesponto duplo, com abertura de 50cm e opção de abertura manual ou motorizado. Almofada decorativa solta 55x55cm sem detalhe de costura. Encosto reclinável com costura em pesponto duplo. Braços fixos com costura em pesponto duplo. Pé em polipropileno injetado na cor preta. *Produto retrátil com opção manual e motorizado.

Fixed seat and backrest. Fixed arm. Loose seat and back cushion. Feet in injected polypropylene in black.

Asiento y respaldo fijos. Brazo fijo. Asiento y cojín del respaldo sueltos. Pies en polipropileno inyectado en color negro.



Grid



SOFÁS
SOFÁS | SOFÁS

ponto**vírgula**



Grid

SOFÁS
SOFÁS | SOFÁS

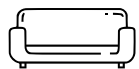

Grid

SOFÁS
SOFÁS | SOFÁS

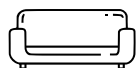
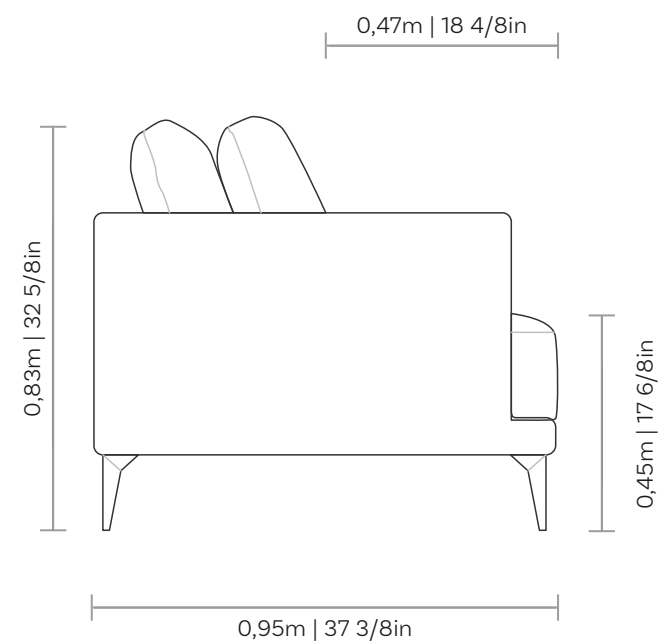
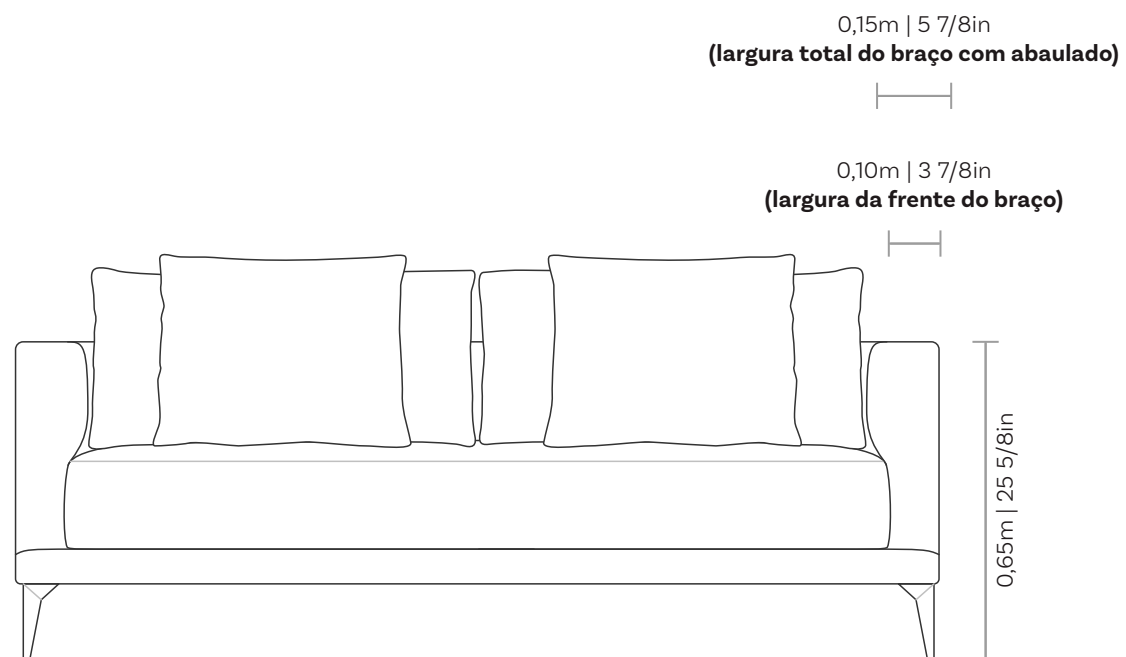

Grid

SOFÁS
SOFÁS | SOFÁS

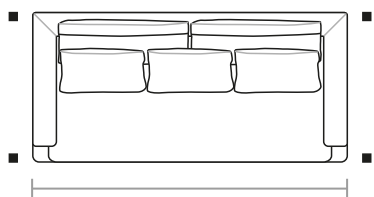

2B 1AS	ASS	ENC	DEC	ROL
1,40 x 0,95 m 55 1/8 x 37 3/8 in	1	1	2	1
1,50 x 0,95 m 59 x 37 3/8 in	1	1	2	1
1,60 x 0,95 m 63 x 37 3/8 in	1	1	2	1
1,70 x 0,95 m 66 7/8 x 37 3/8 in	1	2	2	2
1,80 x 0,95 m 70 7/8 x 37 3/8 in	1	2	2	2
1,90 x 0,95 m 74 6/8 x 37 3/8 in	1	2	2	2
2,00 x 0,95 m 78 6/8 x 37 3/8 in	1	2	3	3
2,10 x 0,95 m 82 5/8 x 37 3/8 in	1	2	3	3
2,20 x 0,95 m 86 5/8 x 37 3/8 in	1	2	3	3
2,30 x 0,95 m 90 4/8 x 37 3/8 in	1	2	3	3
2,40 x 0,95 m 94 4/8 x 37 3/8 in	1	2	3	3
2,50 x 0,95 m 98 3/8 x 37 3/8 in	1	2	3	3
2,60 x 0,95 m 102 3/8 x 37 3/8 in	1	2	4	4

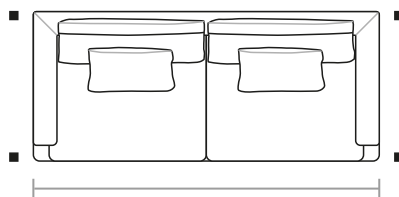

2B 2AS	ASS	ENC	DEC	ROL
2,20 x 0,95 m 86 5/8 x 37 3/8 in	1	2	3	2
2,40 x 0,95 m 94 4/8 x 37 3/8 in	1	2	3	2
2,60 x 0,95 m 102 3/8 x 37 3/8 in	1	2	4	2
2,80 x 0,95 m 110 2/8 x 37 3/8 in	1	2	4	2
3,00 x 0,95 m 118 1/8 x 37 3/8 in	1	2	4	2

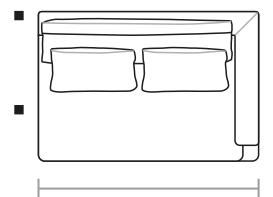

1B 1AS (D/E)	ASS	ENC	DEC	ROL
1,10 x 0,95 m 43 2/8 x 37 3/8 in	1	1	1	1
1,20 x 0,95 m 47 2/8 x 37 3/8 in	1	1	1	1
1,30 x 0,95 m 51 1/8 x 37 3/8 in	1	1	1	1
1,40 x 0,95 m 55 1/8 x 37 3/8 in	1	1	2	1
1,50 x 0,95 m 59 x 37 3/8 in	1	1	2	2
1,60 x 0,95 m 63 x 37 3/8 in	1	2	2	2
1,70 x 0,95 m 66 7/8 x 37 3/8 in	1	2	2	2
1,80 x 0,95 m 70 7/8 x 37 3/8 in	1	2	2	2
1,90 x 0,95 m 74 6/8 x 37 3/8 in	1	2	2	2
2,00 x 0,95 m 78 6/8 x 37 3/8 in	1	2	3	3
2,10 x 0,95 m 82 5/8 x 37 3/8 in	1	2	3	3
2,20 x 0,95 m 86 5/8 x 37 3/8 in	1	2	3	3
2,30 x 0,95 m 90 4/8 x 37 3/8 in	1	2	3	3

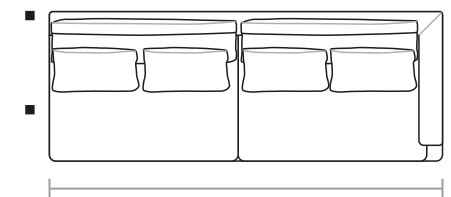

1B 2AS (D/E)	ASS	ENC	DEC	ROL
2,10 x 0,95 m 82 5/8 x 37 3/8 in	1	2	3	2
2,30 x 0,95 m 90 4/8 x 37 3/8 in	1	2	3	2
2,50 x 0,95 m 98 3/8 x 37 3/8 in	1	2	4	2
2,70 x 0,95 m 106 2/8 x 37 3/8 in	1	2	4	2
2,90 x 0,95 m 114 1/8 x 37 3/8 in	1	2	4	2

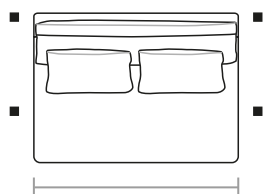

SB 1AS	ASS	ENC	DEC	ROL
1,00 x 0,95 m 39 3/8 x 0,95 in	1	1	1	1
1,10 x 0,95 m 43 2/8 x 0,95 in	1	1	1	1
1,20 x 0,95 m 47 2/8 x 0,95 in	1	1	1	1
1,30 x 0,95 m 51 1/8 x 0,95 in	1	1	2	1
1,40 x 0,95 m 55 1/8 x 0,95 in	1	1	2	1
1,50 x 0,95 m 59 x 0,95 in	1	2	2	2
1,60 x 0,95 m 63 x 0,95 in	1	2	2	2
1,70 x 0,95 m 66 7/8 x 0,95 in	1	2	2	2
1,80 x 0,95 m 70 7/8 x 0,95 in	1	2	2	2
1,90 x 0,95 m 74 6/8 x 0,95 in	1	2	3	3
2,00 x 0,95 m 78 6/8 x 0,95 in	1	2	3	3
2,10 x 0,95 m 82 5/8 x 0,95 in	1	2	3	3
2,20 x 0,95 m 86 5/8 x 0,95 in	1	2	3	3

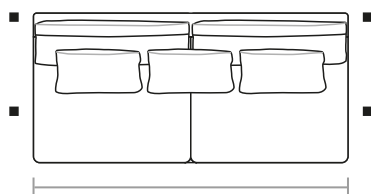

SB 2AS	ASS	ENC	DEC	ROL
2,00 x 0,95 m 78 6/8 x 37 3/8 in	1	2	3	2
2,20 x 0,95 m 86 5/8 x 37 3/8 in	1	2	3	2
2,40 x 0,95 m 94 4/8 x 37 3/8 in	1	2	4	2
2,60 x 0,95 m 102 3/8 x 37 3/8 in	1	2	4	2
2,80 x 0,95 m 110 2/8 x 37 3/8 in	1	2	4	2

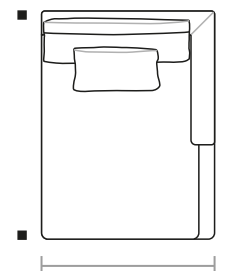

CH 1B (D/E)	ASS	ENC	DEC	ROL
1,10 m x 1,45 m 43 2/8 x 57 1/8 in	1	1	1	1
1,20 m x 1,45 m 47 2/8 x 57 1/8 in	1	1	1	1
1,30 m x 1,45 m 51 1/8 x 57 1/8 in	1	1	1	1
1,40 m x 1,45 m 55 1/8 x 57 1/8 in	1	1	2	1

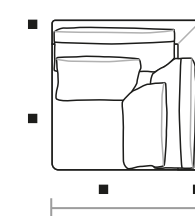

CTO	ASS	ENC	DEC
0,95 x 0,95 m 37 3/8 x 37 3/8 in	1	2	2

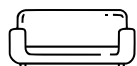

Grid

SOFÁS
SOFÁS | SOFÁS

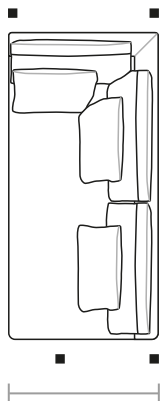

CTO ALONGADO (ENC ATF) (D/E)	ASS	ENC	DEC	ROL
0,95 m x 1,95 m 37 3/8 x 76 6/8 in	1	3	3	3
0,95 m x 2,05 m 37 3/8 x 80 6/8 in	1	3	3	3
0,95 m x 2,15 m 37 3/8 x 84 5/8 in	1	3	3	3
0,95 m x 2,25 m 37 3/8 x 88 5/8 in	1	3	3	3
0,95 m x 2,35 m 37 3/8 x 92 4/8 in	1	3	3	3

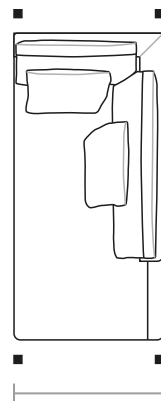

CTO ALONGADO (BICO: 50CM) (D/E)	ASS	ENC	DEC	ROL
0,95 m x 1,95 m 37 3/8 x 76 6/8 in	1	2	3	2
0,95 m x 2,05 m 37 3/8 x 80 6/8 in	1	2	3	2
0,95 m x 2,15 m 37 3/8 x 84 5/8 in	1	2	3	2
0,95 m x 2,25 m 37 3/8 x 88 5/8 in	1	3	3	3
0,95 m x 2,35 m 37 3/8 x 92 4/8 in	1	3	3	3

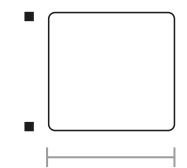

PUFF	ASS
0,60 x 0,75 m 23 5/8 x 29 4/8 in	1
0,80 x 0,75 m 31 4/8 x 29 4/8 in	1
1,20 x 0,75 m 47 2/8 x 29 4/8 in	1

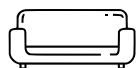

Grid

SOFÁS
SOFÁS | SOFÁS

Assento: fixo, com costura em pesponto simples.
Encosto: fixo, com costura em pesponto simples.
Braço: fixo, fixo, com costura em pesponto simples.
Almofada de assento: fixa, com costura em pesponto simples.
Almofada de encosto: solta, com costura em pesponto simples, com 45cm de altura.
Almofada decorativa: solta, com costura em pesponto simples, com 55x55cm.
Almofada cilíndrica: solta, com costura em pesponto simples, com diâmetro de 8cm.
Suporte: pés em alumínio, disponível nos acabamentos MTX, pintura fosca e pintura metalizada.

Medidas podem apresentar leves variações. Nos reservamos o direito de efetuar alterações sem consulta prévia.

Seat: fixed, with single topstitch seam.
Backrest: fixed, with single topstitch seam.
Armrest: fixed, with single topstitch seam.
Seat cushion: fixed, with single topstitch seam.
Back cushion: loose, with single topstitch seam, 45 cm high.
Decorative cushion: loose, with single topstitch seam, 55x55 cm.
Cylindrical cushion: loose, with single topstitch seam, 8 cm in diameter.
Support: aluminum legs, available in MTX finish, matte paint, and metallic paint.

Measures may vary slightly. We reserve the right to make changes without prior consultation.

*For more information, see our Comfort Guide.

Asiento: fijo, con costura en pespunte simple.
Respaldo: fijo, con costura en pespunte simple.
Brazos: fijos, con costura en pespunte simple.
Cojín de asiento: fijo, con costura en pespunte simple.
Cojín de respaldo: suelto, con costura en pespunte simple, con 45 cm de altura.
Cojín decorativo: suelto, con costura en pespunte simple, de 55x55 cm.
Cojín cilíndrico: suelto, con costura en pespunte simple, con diámetro de 8 cm.
Soporte: pies en aluminio, disponible en acabados MTX, pintura mate y pintura metalizada.

Las medidas pueden variar un poco. Nos reservamos el derecho de realizar cambios sin previa consulta.

*Para más informaciones, consulte nuestro Guía de Confort.

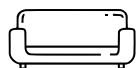

ponto**vírgula**

Isla



SOFÁS
SOFÁS | SOFÁS

ponto**vírgula**



Isla

SOFÁS
SOFÁS | SOFÁS

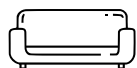

Isla

SOFÁS
SOFÁS | SOFÁS

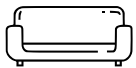
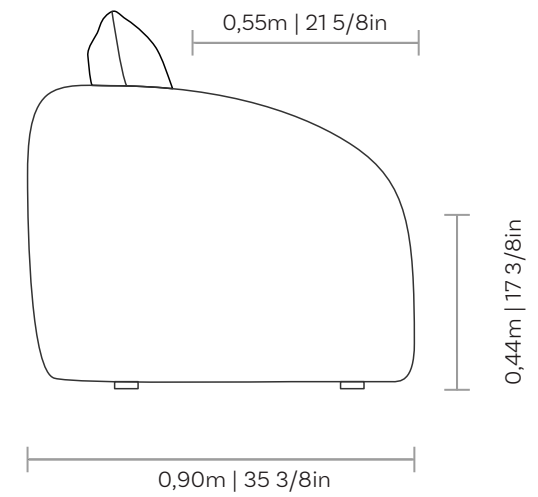
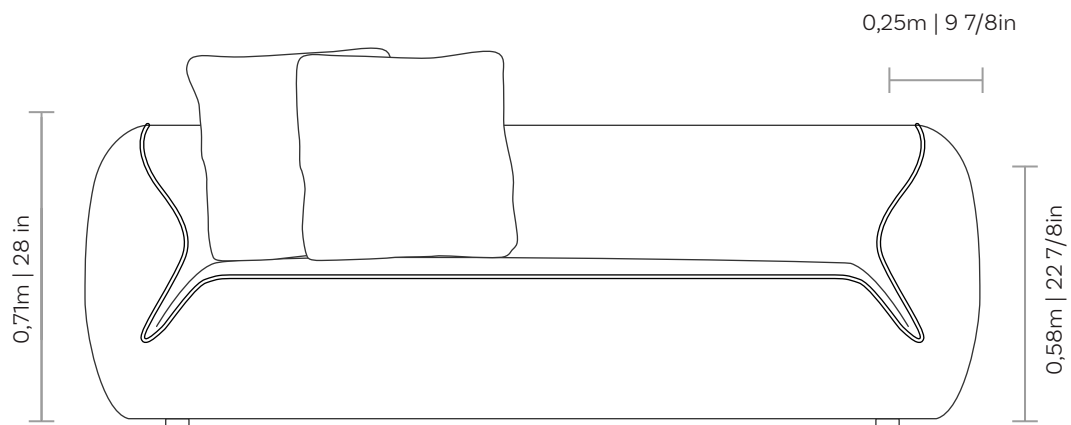

ponto**vírgula**

Isla

SOFÁS
SOFÁS | SOFÁS

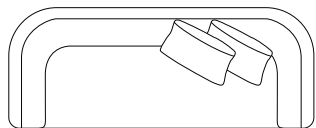

2B1	ASS	DEC
2,10 X 0,90 m 82 5/8 in x 35 3/8 in	1	2
2,30 X 0,90 m 90 4/8 in x 35 3/8 in	1	2
2,50 X 0,90 m 98 3/8 in x 35 3/8 in	1	2
2,70 X 0,90 m 106 2/8 in x 35 3/8 in	1	2
2,90 X 0,90 m 114 1/8 in x 35 3/8 in	1	2
3,10 X 0,90 m 122 in x 35 3/8 in	1	2
3,30 X 0,90 m 129 7/8 in x 35 3/8 in	1	2

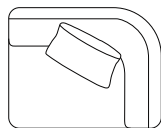

1B1	ASS	DEC
1,05 X 0,90 m 41 3/8 in x 35 3/8 in	1	1
1,15 X 0,90 m 42 2/8 in x 35 3/8 in	1	1
1,25 X 0,90 m 49 2/8 in x 35 3/8 in	1	1
1,35 X 0,90 m 53 1/8 in x 35 3/8 in	1	1
1,45 X 0,90 m 57 1/8 in x 35 3/8 in	1	1
1,55 X 0,90 m 61 in x 35 3/8 in	1	1
1,65 X 0,90 m 65 in x 35 3/8 in	1	1
1,75 X 0,90 m 68 7/8 in x 35 3/8 in	1	1

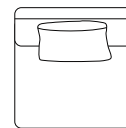

SB1	ASS	DEC
0,80 X 0,90 m 31 4/8 in x 35 3/8 in	1	1
0,90 X 0,90 m 35 3/8 in x 35 3/8 in	1	1
1,00 X 0,90 m 39 3/8 in x 35 3/8 in	1	1
1,10 X 0,90 m 43 2/8 in x 35 3/8 in	1	1
1,20 X 0,90 m 47 2/8 in x 35 3/8 in	1	1
1,30 X 0,90 m 51 1/8 in x 35 3/8 in	1	1
1,40 X 0,90 m 55 1/8 in x 35 3/8 in	1	1
1,50 X 0,90 m 59 in x 35 3/8 in	1	1



PUFF CTO	ASS
0,90 X 0,90 m 35 3/8 in x 35 3/8 in	1

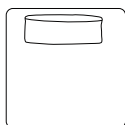

PUFF ILHA	LOMB
0,80 X 0,70 m 31 4/8 in x 27 4/8 in	1
0,90 X 0,70 m 35 3/8 in x 27 4/8 in	1
1,00 X 0,70 m 39 3/8 in x 27 4/8 in	1
1,10 X 0,70 m 43 2/8 in x 27 4/8 in	1
1,20 X 0,70 m 47 2/8 in x 27 4/8 in	2
1,30 X 0,70 m 51 1/8 in x 27 4/8 in	2
1,40 X 0,70 m 55 1/8 in x 27 4/8 in	2
1,50 X 0,70 m 59 in x 27 4/8 in	2

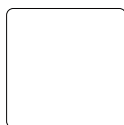

PUFF BI	ASS
0,80 X 0,90 m 31 4/8 in x 35 3/8 in	1
0,90 X 0,90 m 35 3/8 in x 35 3/8 in	1
1,00 X 0,90 m 39 3/8 in x 35 3/8 in	1
1,10 X 0,90 m 43 2/8 in x 35 3/8 in	1
1,20 X 0,90 m 47 2/8 in x 35 3/8 in	1
1,30 X 0,90 m 51 1/8 in x 35 3/8 in	1
1,40 X 0,90 m 55 1/8 in x 35 3/8 in	1
1,50 X 0,90 m 59 in x 35 3/8 in	1



PUFF	ASS
0,80 X 0,60 m 31 4/8 in x 23 5/8 in	1
0,90 X 0,60 m 35 3/8 in x 23 5/8 in	1
1,00 X 0,60 m 39 3/8 in x 23 5/8 in	1
1,10 X 0,60 m 43 2/8 in x 23 5/8 in	1
1,20 X 0,60 m 47 2/8 in x 23 5/8 in	1

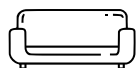

Isla

SOFÁS
SOFÁS | SOFÁS

Encosto: fixo, com costura em debrum composê.
Assento: fixo, com costura em debrum composê.
Braço: fixo, com costura em debrum composê.
Almofada decorativa: solta, sem detalhe de costura, de 0,45x0,45m.
Suporte: pés em polipropileno injetado na cor preta.
OBS.: no módulo puff ilha, pés em borracha na cor preta, para que o módulo seja colocado na parte traseira do sofá sem necessidade de engates.

Medidas podem apresentar leves variações. Nos reservamos o direito de efetuar alterações sem consulta prévia.

Backrest: fixed, with composite piping stitching.
Seat: fixed, with composite piping stitching.
Armrest: fixed, with composite piping stitching.
Decorative cushion: loose, with 0,45x0,45m, without seam detail.
Feet: injected polypropylene in black color.
NOTE: on the puff island module, black rubber feet, so that the module can be placed on the back of the sofa without the need for hitches.

Measures may vary slightly. We reserve the right to make changes without prior consultation.

*For more information, see our Comfort Guide.

Respaldo: fijo, con costuras de ribete compuesto.
Asiento: fijo, con costuras de ribete compuesto.
Brazos: fijo, con costuras de ribete compuesto.
Cojín decorativo: suelto, 0,45x0,45m, sin detalle de costura.
Patas: polipropileno inyectado en color negro.
NOTA: en el módulo puff isla, pies de goma negros, para que el módulo se pueda colocar en el respaldo del sofá sin necesidad de enganches.hitches.

Las medidas pueden variar un poco. Nos reservamos el derecho de realizar cambios sin previa consulta.

*Para más informaciones, consulte nuestro Guía de Confort.

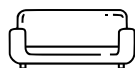

ponto**vírgula**

JOPLIN

sofá living



ponto **vírgula**

JOPLIN

sofá living

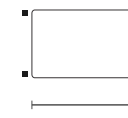
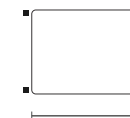
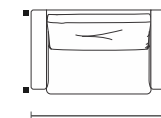
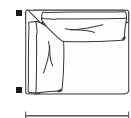
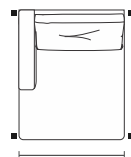
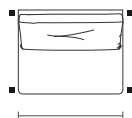
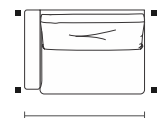
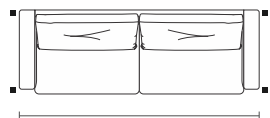
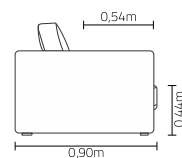
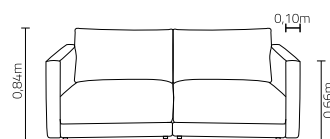

2B2	ASS	ENC	BRA
1,60 m	2	2	2
1,80 m	2	2	2
2,00 m	2	2	2
2,20 m	2	2	2
2,40 m	2	2	2
2,60 m	2	2	2
2,80 m	2	2	2

1B1 (D/E)	ASS	ENC	BRA
0,80 m	1	1	1
0,90 m	1	1	1
1,00 m	1	1	1
1,10 m	1	1	1
1,20 m	1	1	1
1,30 m	1	1	1

SB 1	ASS	ENC
0,70 m	1	1
0,80 m	1	1
0,90 m	1	1
1,00 m	1	1
1,20 m	1	1
1,20 m	1	1

CH 1B(D/E)	ASS	ENC	BRA
1,00 x 1,60m	1	1	1
0,90 m	1	1	1
1,00 m	1	1	1
1,10 x 1,60m	1	1	1
1,20 x 1,60m	1	1	1
1,30 x 1,60m	1	1	1

CTO (D/E)	ASS	ENC	BRA
0,90 x 0,90 m	1	2	1

POL
1,00 x 0,90 m

PUFF CTO
0,90 x 0,90 m

PUFF
0,70 x 0,60 m
0,80 x 0,60 m
0,90 x 0,60 m
1,00 x 0,60 m

Assento, almofada de assento e encosto fixos com costura em pesponto simples. Almofada de encosto solta sem detalhe de costura. Pés em polipropileno injetado.

Fixed seat, seat cushion and backrest. Loose back cushion. Feet in injected polypropylene.

Asiento, cojín de asiento y respaldo fijos. Cojín trasero suelto. Pies desmontables en polipropileno inyectado.



Julian



SOFÁS
SOFÁS | SOFÁS

ponto**vírgula**



Julian

SOFÁS
SOFÁS | SOFÁS

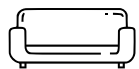

Julian

SOFÁS
SOFÁS | SOFÁS

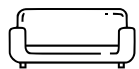
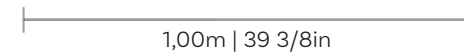
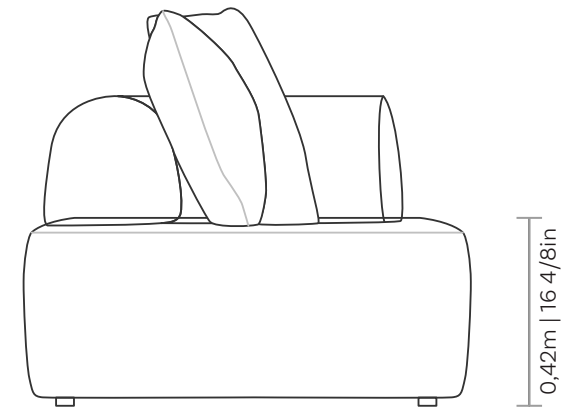
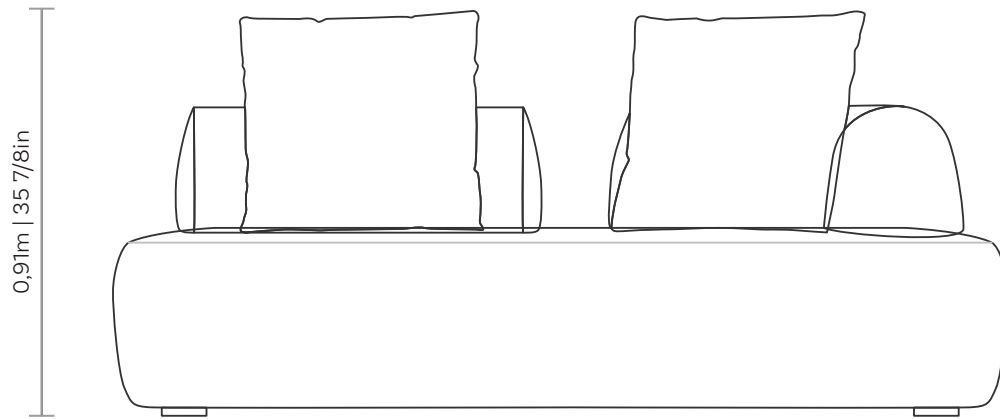

Julian

SOFÁS
SOFÁS | SOFÁS



ASS	ASS
1,00 m 39 3/8 in	1
1,20 m 47 2/8 in	1
1,40 m 55 1/8 in	1
1,60 m 63 in	1
1,80 m 70 7/8 in	1
2,00 m 78 6/8 in	1
2,20 m 86 5/8 in	1
2,40 m 94 4/8 in	1

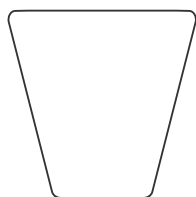

ASS CTO
0,50 x 1,00 x 1,00 m 19 5/8 x 39 3/8 x 39 3/8 in

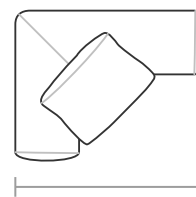

ENC 1B	DEC
0,60 x 0,80 m 23 5/8 x 31 4/8 in	1
0,70 x 0,80 m 27 4/8 x 31 4/8 in	1
0,80 x 0,80 m 31 4/8 x 31 4/8 in	1
0,90 x 0,80 m 35 3/8 x 31 4/8 in	1
1,00 x 0,80 m 39 3/8 x 31 4/8 in	1
1,10 x 0,80 m 43 2/8 x 31 4/8 in	1
1,20 x 0,80 m 47 2/8 x 31 4/8 in	1

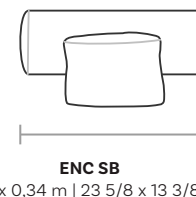

ENC SB	DEC
0,60 x 0,34 m 23 5/8 x 13 3/8 in	1
0,70 x 0,34 m 27 4/8 x 13 3/8 in	1
0,80 x 0,34 m 31 4/8 x 13 3/8 in	1
0,90 x 0,34 m 35 3/8 x 13 3/8 in	1
1,00 x 0,34 m 39 3/8 x 13 3/8 in	1
1,10 x 0,34 m 43 2/8 x 13 3/8 in	1
1,20 x 0,34 m 47 2/8 x 13 3/8 in	1



ENC CURVO	DEC
1,00 x 0,55 m 39 3/8 x 21 5/8 in	1

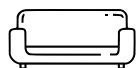

Julian

SOFÁS
SOFÁS | SOFÁS

Assento: fixo, costurado com pesponto duplo e fole.
Encosto: solto com superfície antiderrapante, costura em pesponto simples.
Almofada: decorativa, acompanha o encosto, 55x55 cm enchimento em fibra.
Pés: polipropileno injetado na cor preta.

Medidas podem apresentar leves variações. Nos reservamos o direito de efetuar alterações sem consulta prévia.

Seat: fixed, with double topstitching.
Backrest: loose with non-slip surface, simple stitching.
Cushion: decorative, comes with the backrest, 55x55 cm. with fiber filling.
Feet: injected polypropylene in black color.

Measures may vary slightly. We reserve the right to make changes without prior consultation.
*For more information, see our Comfort Guide.

Asiento: fijo, con doble pespunte y fuelle.
Respaldo: suelto con superficie antideslizante, costuras simples.
Cojín: decorativo, viene con o respaldo, 55x55 cm con relleno de fibra.
Patas: polipropileno inyectado en color negro.

Las medidas pueden variar un poco. Nos reservamos el derecho de realizar cambios sin previa consulta.
*Para más informaciones, consulte nuestro Guía de Confort.

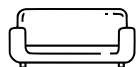

KIEDIS

sofá living



ponto **vírgula**

KIEDIS

sofá living

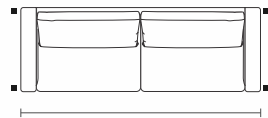
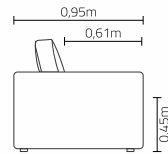
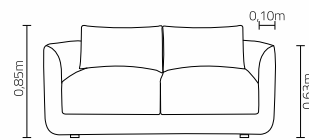

2B2	ASS	ENC	BRA
1,60 m	2	2	2
1,80 m	2	2	2
2,00 m	2	2	2
2,20 m	2	2	2
2,40 m	2	2	2
2,60 m	2	2	2
2,80 m	2	2	2

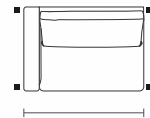

1B1 (D/E)	ASS	ENC	BRA
0,80 m	1	1	1
0,90 m	1	1	1
1,00 m	1	1	1
1,10 m	1	1	1
1,20 m	1	1	1
1,30 m	1	1	1

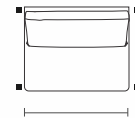

SB1	ASS	ENC
0,70 m	1	1
0,80 m	1	1
0,90 m	1	1
1,00 m	1	1
1,10 m	1	1
1,20 m	1	1

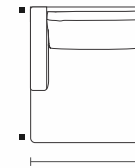

CH1B (D/E)	ASS	ENC	BRA
1,00 x 1,60m	1	1	1
1,10 x 1,60m	1	1	1
1,20 x 1,60m	1	1	1
1,30 x 1,60m	1	1	1

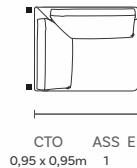

CTO	ASS	ENC
0,95 x 0,95m	1	2

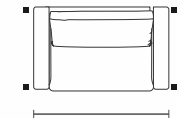

POL
1,00 x 0,95 m

Assento, almofada de assento, encosto e braços fixos com costura em pesponto simples, Almofada de encosto solta sem detalhe de costura. Pés em polipropileno injetado.

Seat, seat cushion, backrest and armrests fixed with simple topstitching, Loose back cushion without sewing detail. Feet in injected polypropylene.

Asiento, cojín de asiento, respaldo y reposabrazos fijados con pespuntos sencillos, Cojín de respaldo suelto sin detalle de costura. Pies en polipropileno injetado.



KIEDIS

sofá living

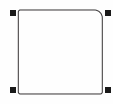
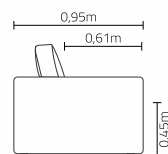
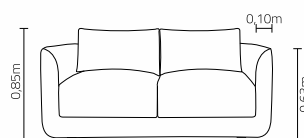

PUFF CTO
0,95 x 0,95 m

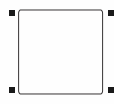

PUFF
0,95 x 0,95 m

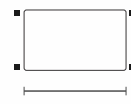

PUFF
0,70 x 0,60 m
0,80 x 0,60 m
0,90 x 0,60 m
1,00 x 0,60 m

Assento, almofada de assento, encosto e braços fixos com costura em pesponto simples, Almofada de encosto solta sem detalhe de costura. Pés em polipropileno injetado.

Seat, seat cushion, backrest and armrests fixed with simple topstitching, Loose back cushion without sewing detail. Feet in injected polypropylene.

Asiento, cojín de asiento, respaldo y reposabrazos fijados con pespuntos sencillos, Cojín de respaldo suelto sin detalle de costura. Pies en polipropileno inyectado.



Klee



SOFÁS
SOFAS | SOFÁS

ponto**vírgula**



Klee

SOFÁS
SOFÁS | SOFÁS

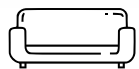

ponto**vírgula**

Klee

SOFÁS
SOFÁS | SOFÁS

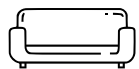
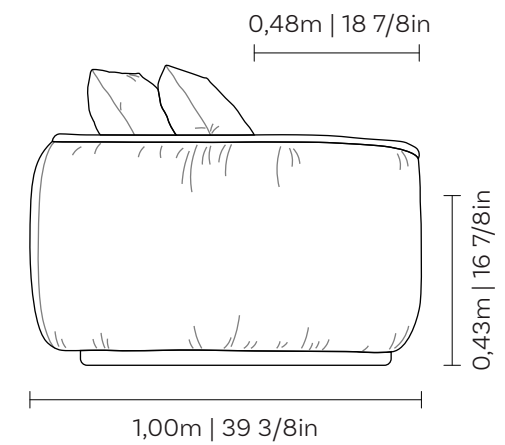
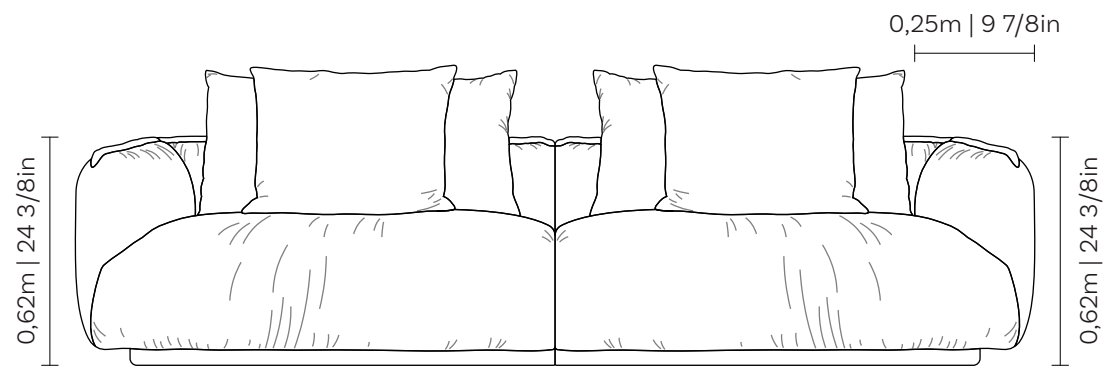

pontovírgula

Klee

SOFÁS
SOFÁS | SOFÁS

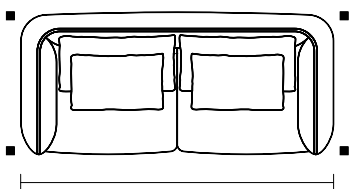

2B 2AS	ASS	ENC	DEC
2,20 x 1,00 m 86 5/8 x 39 3/8 in	2	2	2
2,40 x 1,00 m 94 4/8 x 39 3/8 in	2	2	2
2,60 x 1,00 m 102 3/8 x 39 3/8 in	2	2	2
2,80 x 1,00 m 110 2/8 x 39 3/8 in	2	2	2
3,00 x 1,00 m 118 1/8 x 39 3/8 in	2	2	2

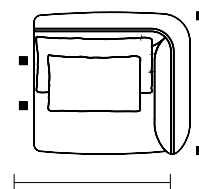

1B 1AS (D/E)	ASS	ENC	DEC
1,10 x 1,00 m 43 2/8 x 39 3/8 in	1	1	1
1,20 x 1,00 m 47 2/8 x 39 3/8 in	1	1	1
1,30 x 1,00 m 51 1/8 x 39 3/8 in	1	1	1
1,40 x 1,00 m 55 1/8 x 39 3/8 in	1	1	1
1,50 x 1,00 m 59 x 39 3/8 in	1	1	1

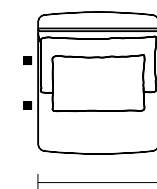

SB 1AS	ASS	ENC	DEC
0,85 x 1,00 m 33 4/8 x 39 3/8 in	1	1	1
0,95 x 1,00 m 37 3/8 x 39 3/8 in	1	1	1
1,05 x 1,00 m 41 3/8 x 39 3/8 in	1	1	1
1,15 x 1,00 m 45 2/8 x 39 3/8 in	1	1	1
1,25 x 1,00 m 49 2/8 x 39 3/8 in	1	1	1

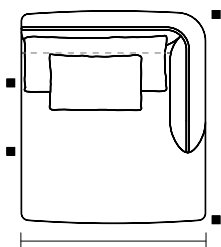

CH 1B (D/E)	ASS	ENC	DEC
1,30 x 1,50 m 51 1/8 x 59 in	1	1	1
1,40 x 1,50 m 55 1/8 x 59 in	1	1	1
1,50 x 1,50 m 59 x 59 in	1	1	1

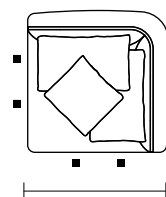

CTO	ASS	ENC	DEC
1,00 x 1,00 m 39 3/8 x 39 3/8 in	1	2	2

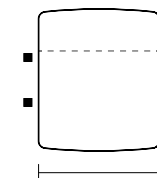

PUFF MEIO	ASS
0,85 x 1,00 m 33 4/8 x 39 3/8 in	1
0,95 x 1,00 m 37 3/8 x 39 3/8 in	1
1,05 x 1,00 m 41 3/8 x 39 3/8 in	1
1,15 x 1,00 m 45 2/8 x 39 3/8 in	1
1,25 x 1,00 m 49 2/8 x 39 3/8 in	1

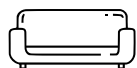

sentido do tecido
das modulações



pontovírgula

Klee

SOFÁS
SOFÁS | SOFÁS

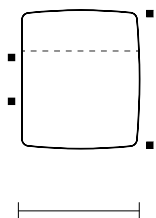

PUFF BI (D/E)	ASS
0,85 x 1,00 m 33 4/8 x 39 3/8 in	1
0,95 x 1,00 m 37 3/8 x 39 3/8 in	1
1,05 x 1,00 m 41 3/8 x 39 3/8 in	1
1,15 x 1,00 m 45 2/8 x 39 3/8 in	1
1,25 x 1,00 m 49 2/8 x 39 3/8 in	1

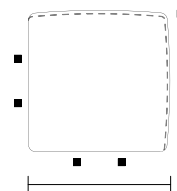

PUFF CTO	ASS
1,00 x 1,00 m 39 3/8 x 39 3/8 in	1

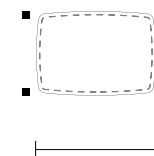

PUFF	ASS
0,85 x 0,60 m 33 4/8 x 23 5/8 in	1
0,95 x 0,60 m 37 3/8 x 23 5/8 in	1
1,05 x 0,60 m 41 3/8 x 23 5/8 in	1
1,15 x 0,60 m 45 2/8 x 23 5/8 in	1
1,25 x 0,60 m 49 2/8 x 23 5/8 in	1

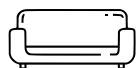

sentido do tecido
das modulações



pontovírgula

Klee

SOFÁS
SOFÁS | SOFÁS

Assento: fixo, com costura em fole de 2,5cm.
Encosto: fixo, com costura em fole de 2,5cm.
Braço: fixo, com costura em fole de 2,5cm.
Almofada de Encosto: solta, sem detalhe de costura, com 65x55cm.
Almofada Decorativa: solta, sem detalhe de costura, com altura de 55cm.
Suporte: pés em polipropileno injetado, na cor preta.

Medidas podem apresentar leves variações. Nos reservamos o direito de efetuar alterações sem consulta prévia.

Seat: Fixed, with 2.5 cm pleated stitching.
Backrest: Fixed, with 2.5 cm pleated stitching.
Armrest: Fixed, with 2.5 cm pleated stitching.
Back Cushion: Loose, without stitching details, measuring 65 × 55 cm.
Decorative Cushion: Loose, without stitching details, with a height of 55 cm.
Support: Injected polypropylene feet, in black.

Measures may vary slightly. We reserve the right to make changes without prior consultation.
*For more information, see our Comfort Guide.

Asiento: Fijo, con costura en pliegue de 2,5 cm.
Respaldo: Fijo, con costura en pliegue de 2,5 cm.
Brazos: Fijos, con costura en pliegue de 2,5 cm.
Cojín de Respaldo: Suelto, sin detalles de costura, de 65 × 55 cm.
Cojín Decorativo: Suelto, sin detalles de costura, con una altura de 55 cm.
Soporte: Patas de polipropileno inyectado, en color negro.

Las medidas pueden variar un poco. Nos reservamos el derecho de realizar cambios sin previa consulta.
*Para más informaciones, consulte nuestro Guía de Confort.

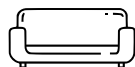

ponto**vírgula**

Lago



SOFÁS
SOFAS | SOFÁS

ponto**vírgula**



Lago

SOFÁS
SOFAS | SOFÁS

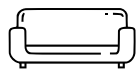

Lago

SOFÁS
SOFAS | SOFÁS

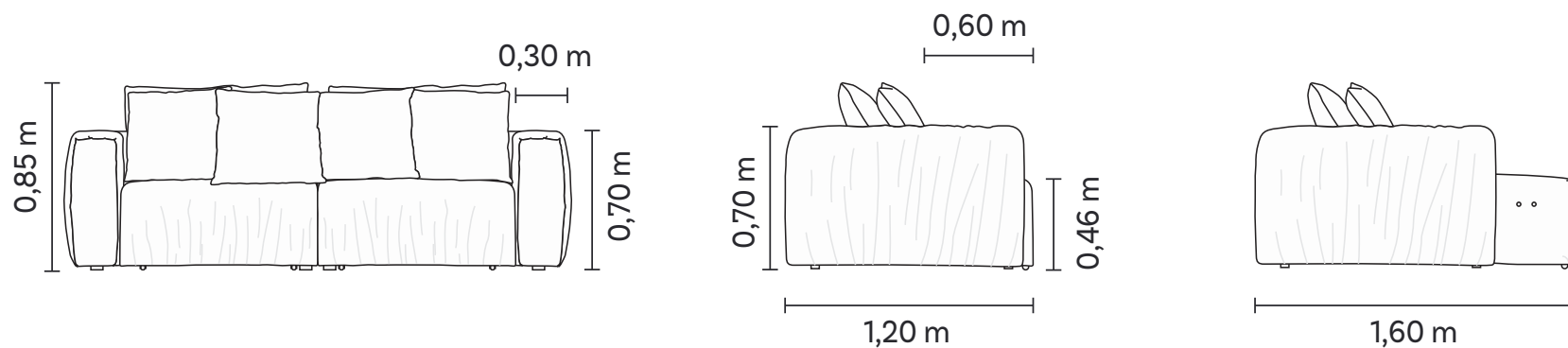

Assento retrátil, com abertura de 40 cm, com sobra de tecido e sem detalhe de costura. Encosto e braço fixos com sobra de tecido, sem detalhe de costura. Almofada de encosto solta, sem detalhe de costura. Pés em polipropileno injetado na cor preta.

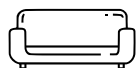

Lago

SOFÁS
SOFAS | SOFÁS

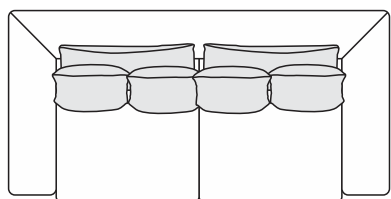

2B2	ENC	DEC
2,20m	2	4
2,40m	2	4
2,60m	2	4
2,80m	2	4
3,00m	2	4

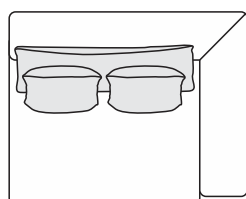

1B1	ENC	DEC
1,10m	1	2
1,20m	1	2
1,30m	1	2
1,40m	1	2
1,50m	1	2

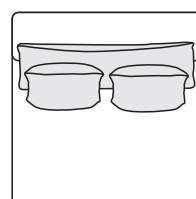

SB1	ENC	DEC
0,80m	1	2
0,90m	1	2
1,00m	1	2
1,10m	1	2
1,20m	1	2

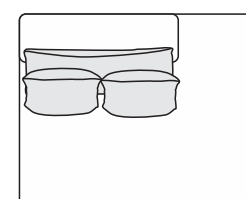

SBBI	ENC	DEC
1,30m	1	2
1,40m	1	2
1,50m	1	2
1,60m	1	2
1,70m	1	2

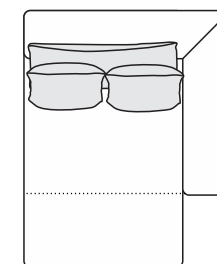

CH 1B (D/E)	ENC	DEC
1,10m x 1,60m	1	2
1,20m x 1,60m	1	2
1,30m x 1,60m	1	2
1,40m x 1,60m	1	2
1,50m x 1,60m	1	2

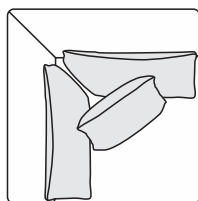

CTO	ENC	DEC
1,20m	2	1

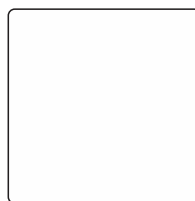

PUFF CTO
1,20m x 1,20m

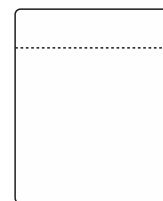

PUFF MEIO
0,80m x 1,20m
0,90m x 1,20m
1,00m x 1,20m
1,10m x 1,20m
1,20m x 1,20m

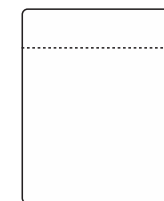

PUFF BI (D/E)
0,80m x 1,20m
0,90m x 1,20m
1,00m x 1,20m
1,10m x 1,20m
1,20m x 1,20m

Lee



SOFÁS
SOFÁS | SOFÁS

ponto**vírgula**



Lee

SOFÁS
SOFÁS | SOFÁS

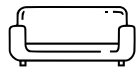

Lee

SOFÁS
SOFÁS | SOFÁS

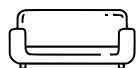
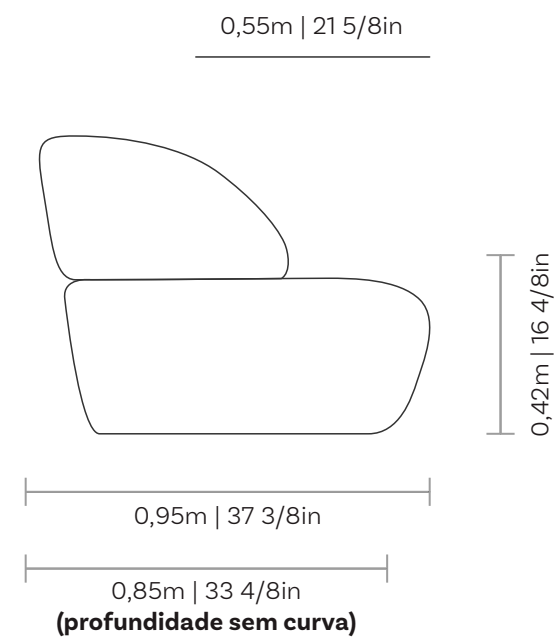
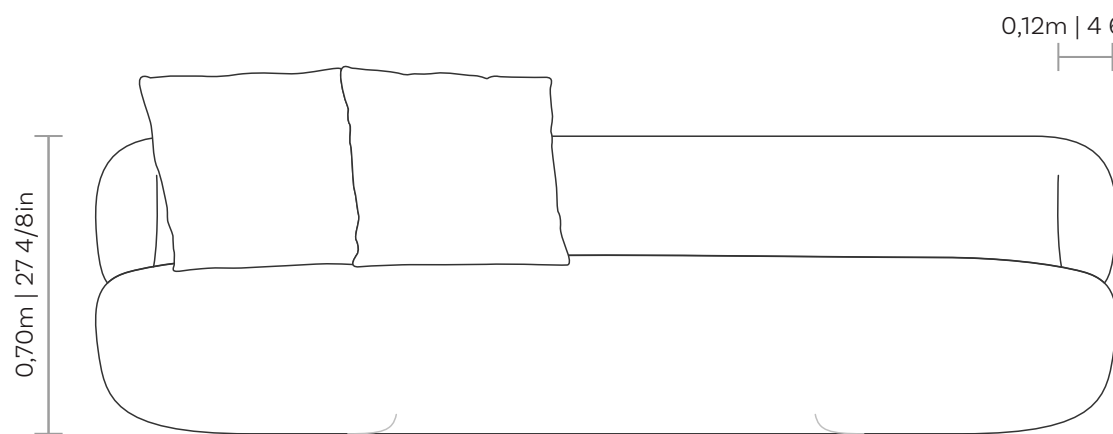

Lee

SOFÁS
SOFÁS | SOFÁS

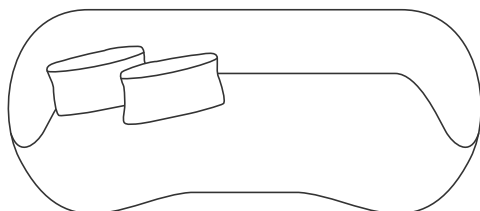

2B 1AS	ASS	DEC
1,60 x 0,95 m 63 x 37 3/8 in	1	2
1,80 x 0,95 m 70 7/8 x 37 3/8 in	1	2
2,00 x 0,95 m 78 6/8 x 37 3/8 in	1	2
2,20 x 0,95 m 86 5/8 x 37 3/8 in	1	2
2,40 x 0,95 m 94 4/8 x 37 3/8 in	1	2
2,60 x 0,95 m 102 3/8 x 37 3/8 in	1	2
2,80 x 0,95 m 110 2/8 x 37 3/8 in	1	2
3,00 x 0,95 m 118 1/8 x 37 3/8 in	1	2

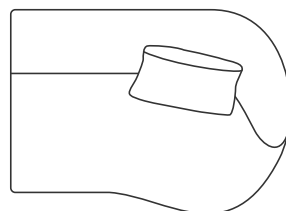

1B 1AS	ASS	DEC
1,00 x 0,95 m 39 3/8 x 37 3/8 in	1	1
1,10 x 0,95 m 43 2/8 x 37 3/8 in	1	1
1,20 x 0,95 m 47 2/8 x 37 3/8 in	1	1
1,30 x 0,95 m 51 1/8 x 37 3/8 in	1	1
1,40 x 0,95 m 55 1/8 x 37 3/8 in	1	1
1,50 x 0,95 m 59 x 37 3/8 in	1	1
1,60 x 0,95 m 63 x 37 3/8 in	1	1
1,70 x 0,95 m 66 7/8 x 37 3/8 in	1	1
1,80 x 0,95 m 70 7/8 x 37 3/8 in	1	1
1,90 x 0,95 m 74 6/8 x 37 3/8 in	1	1
2,00 x 0,95 m 78 6/8 x 37 3/8 in	1	1

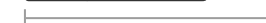
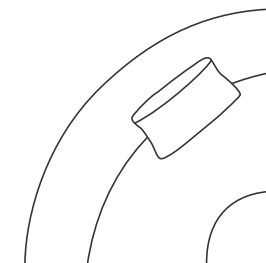

CTO	ASS	DEC
1,20 x 1,20 m 47 2/8 x 47 2/8 in	1	1

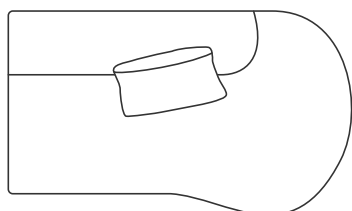

SB BI	ASS	DEC
1,20 x 0,95 m 47 2/8 x 37 3/8 in	1	1
1,30 x 0,95 m 51 1/8 x 37 3/8 in	1	1
1,40 x 0,95 m 55 1/8 x 37 3/8 in	1	1
1,50 x 0,95 m 59 x 37 3/8 in	1	1
1,60 x 0,95 m 63 x 37 3/8 in	1	1
1,70 x 0,95 m 66 7/8 x 37 3/8 in	1	1
1,80 x 0,95 m 70 7/8 x 37 3/8 in	1	1
1,90 x 0,95 m 74 6/8 x 37 3/8 in	1	1
2,00 x 0,95 m 78 6/8 x 37 3/8 in	1	1



PUFF MEIO	ASS
0,80 x 0,85 m 31 4/8 x 33 4/8 in	1
0,90 x 0,85 m 35 3/8 x 33 4/8 in	1
1,00 x 0,85 m 39 3/8 x 33 4/8 in	1
1,10 x 0,85 m 43 2/8 x 33 4/8 in	1
1,20 x 0,85 m 47 2/8 x 33 4/8 in	1
1,30 x 0,85 m 51 1/8 x 33 4/8 in	1
1,40 x 0,85 m 55 1/8 x 33 4/8 in	1



PUFF	ASS
0,80 x 0,70 m 31 4/8 x 27 4/8 in	1
0,90 x 0,70 m 35 3/8 x 27 4/8 in	1
1,00 x 0,70 m 39 3/8 x 27 4/8 in	1
1,10 x 0,70 m 43 2/8 x 27 4/8 in	1
1,20 x 0,70 m 47 2/8 x 27 4/8 in	1
1,30 x 0,70 m 51 1/8 x 27 4/8 in	1
1,40 x 0,70 m 55 1/8 x 27 4/8 in	1

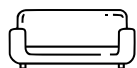

Lee

SOFÁS
SOFÁS | SOFÁS

Assento: fixo, com costura em pesponto duplo.
Encosto: fixo, com costura em pesponto duplo.
Braço: fixo, com costura em pesponto duplo.
Suporte: pés em polipropileno injetado na cor preta.
Almofada decorativa: solta, com 55x55cm, sem detalhe de costura.

Medidas podem apresentar leves variações. Nos reservamos o direito de efetuar alterações sem consulta prévia.

Seat: fixed, with double backstitch.
Backrest: fixed, with double backstitch.
Armrest: fixed, with double backstitch.
Support: feet in injected polypropylene in black color.
Decorative cushion: loose, with 55x55cm, without seam detail.

Measures may vary slightly. We reserve the right to make changes without prior consultation.
*For more information, see our Comfort Guide.

Asiento: fijo con doble pespunte.
Respaldo: fijo con doble pespunte.
Brazos: fijos con doble pespunte.
Patas: polipropileno inyectado en color negro.
Cojín decorativo: suelto, 55 x 55 cm, sin detalle de costura.

Las medidas pueden variar un poco. Nos reservamos el derecho de realizar cambios sin previa consulta.
*Para más informaciones, consulte nuestro Guía de Confort.

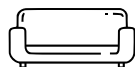

Lior



SOFÁS
SOFAS | SOFÁS

ponto**vírgula**



Lior

SOFÁS
SOFÁS | SOFÁS

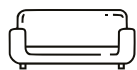

Lior

SOFÁS
SOFÁS | SOFÁS

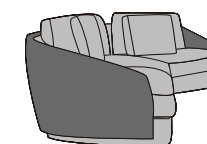
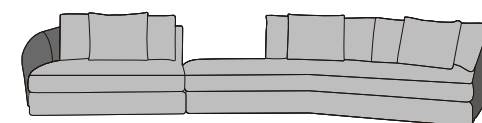
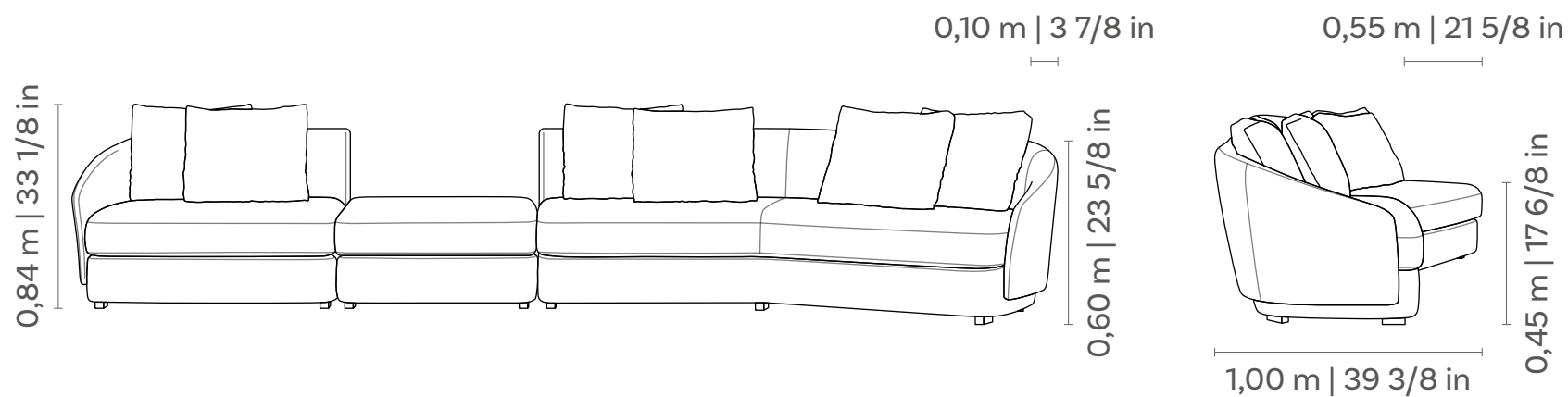

caixa
corpo

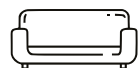

pontovírgula

Lior

SOFÁS
SOFÁS | SOFÁS

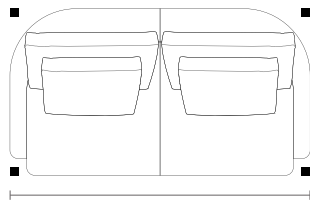

2B2	ASS	DEC	ENC
1,80 m 70 7/8 in	2	2	2
2,00 m 78 6/8 in	2	2	2
2,20 m 86 5/8 in	2	2	2
2,40 m 94 4/8 in	2	2	2
2,60 m 102 3/8 in	2	2	2
2,80 m 110 2/8 in	2	2	2
3,00 m 118 1/8 in	2	2	2

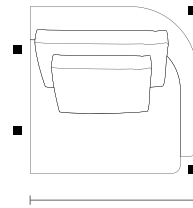

1B1	ASS	DEC	ENC
1,00 m 39 3/8 in	1	1	1
1,10 m 43 2/8 in	1	1	1
1,20 m 47 2/8 in	1	1	1
1,30 m 51 1/8 in	1	1	1
1,40 m 55 1/8 in	1	1	1
1,50 m 59 in	1	1	1

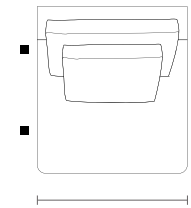

SB1	ASS	DEC	ENC
0,90 m 35 3/8 in	1	1	1
1,00 m 39 3/8 in	1	1	1
1,10 m 43 2/8 in	1	1	1
1,20 m 47 2/8 in	1	1	1
1,30 m 51 1/8 in	1	1	1
1,40 m 55 1/8 in	1	1	1

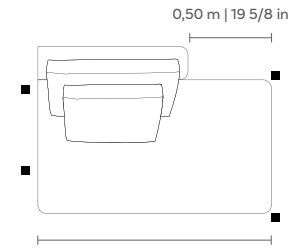

SBBI (D/E)	ASS	DEC	ENC
1,40 m 55 1/8 in	1	1	1
1,50 m 59 in	1	1	1
1,60 m 63 in	1	1	1
1,70 m 66 7/8 in	1	1	1
1,80 m 70 7/8 in	1	1	1
1,90 m 74 6/8 in	1	1	1

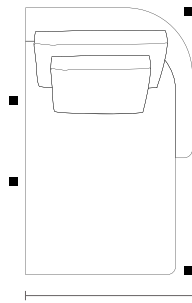

CH1B	ASS	DEC	ENC
1,00 x 1,60 m 39 3/8 x 63 in	1	1	1
1,10 x 1,60 m 43 2/8 x 63 in	1	1	1
1,20 x 1,60 m 47 2/8 x 63 in	1	1	1
1,30 x 1,60 m 51 1/8 x 63 in	1	1	1
1,40 x 1,60 m 55 1/8 x 63 in	1	1	1

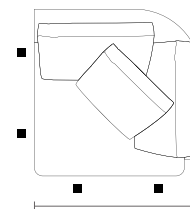

PUFF CTO	ASS	ENC	DEC
1,00 x 1,00 m 39 3/8 x 39 3/8 in	1	2	1

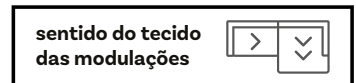
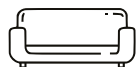

pontovírgula

Lior

SOFÁS
SOFÁS | SOFÁS

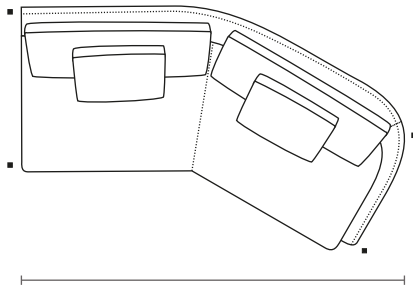

1B1 (D/E) CURVO	ASS	ENC	DEC
2,10 m x 1,45 m 82 5/8 x 57 1/8 in	1	2	2
2,30 x 1,50 m 90 4/8 x 59 in	1	2	2
2,50 x 1,55 m 98 3/8 x 61 in	1	2	2
2,70 x 1,60 m 106 2/8 x 63 in	1	3	3
2,90 x 1,65 m 114 1/8 x 65 in	1	3	3
3,10 x 1,70 m 122 x 66 7/8 in	1	3	3

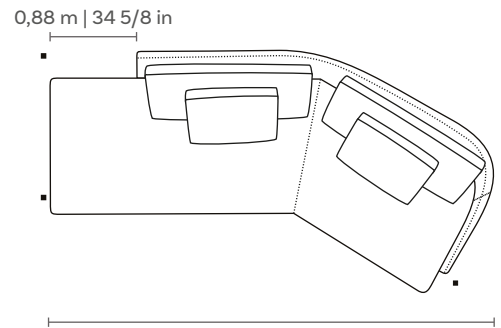

1BBI (D/E) CURVO	ASS	ENC	DEC
2,25 x 1,45 m 88 5/8 x 57 1/8 in	1	2	2
2,35 x 1,50 m 92 3/8 x 59 in	1	2	2
2,45 x 1,55 m 96 4/8 x 61 in	1	2	2
2,55 x 1,60 m 100 3/8 x 63 in	1	2	2
2,65 x 1,65 m 104 3/8 x 65 in	1	2	2
2,75 x 1,70 m 108 2/8 x 66 7/8 in	1	2	2

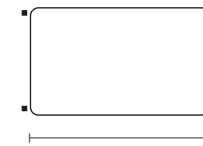

PUFF

1,00 x 0,60 cm | 39 3/8 x 23 5/8 in
 1,10 x 0,60 m | 43 2/8 x 23 5/8 in
 1,20 x 0,60 m | 47 2/8 x 23 5/8 in
 1,30 x 0,60 m | 51 1/8 x 23 5/8 in
 1,40 x 0,60 m | 55 1/8 x 23 5/8 in

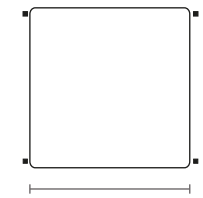

PUFF CTO

0,90 x 0,90 cm | 35 3/8 x 35 3/8 in

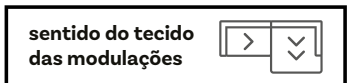
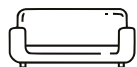

sentido do tecido
das modulações

ponto**vírgula**

Lior

SOFÁS
SOFÁS | SOFÁS

Assento fixo com costura em pesponto simples. Encosto e braços fixos com costuras em pesponto simples na opção em tecido e pesponto duplo na opção em couro. Almofada de assento solta com costura em pesponto simples. Opção de almofada de encosto solta, aberta ou fechada sem detalhe de costura, com almofadas decorativas soltas 50x50cm sem detalhe de costura. Pés em polipropileno injetado na cor preta.

Medidas podem apresentar leves variações. Nos reservamos o direito de efetuar alterações sem consulta prévia.

Fixed seat with simple topstitching. Fixed back and armrests with single topstitching in the fabric option and double topstitching in the leather option. Loose seat cushion with simple topstitching. Option of loose, open or closed backrest cushion without stitching detail, with loose decorative pillows 50x50cm without stitching detail. Feet in injected polypropylene in black.

Measures may vary slightly. We reserve the right to make changes without prior consultation.

Asiento fijo con pespuntos sencillos. Respaldo y reposabrazos fijos con pespunte simple en la opción tela y pespunte doble en la opción piel. Cojín de asiento suelto con pespuntos sencillos. Opción de cojín de respaldo suelto, abierto o cerrado sin detalle de costura, con cojines decorativos sueltos de 50x50cm sin detalle de costura. Pies en polipropileno inyectado en color negro.

Las medidas pueden variar un poco. Nos reservamos el derecho de realizar cambios sin previa consulta.

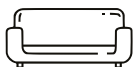

ponto**vírgula**

Manifold



SOFÁS
SOFÁS | SOFÁS

ponto**vírgula**



Manifold

SOFÁS
SOFÁS | SOFÁS

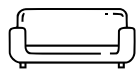

Manifold

SOFÁS
SOFÁS | SOFÁS

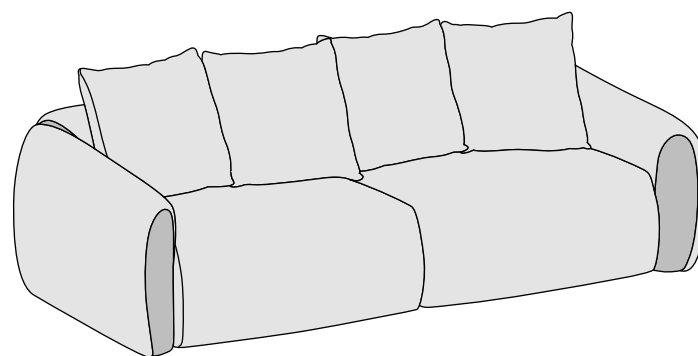
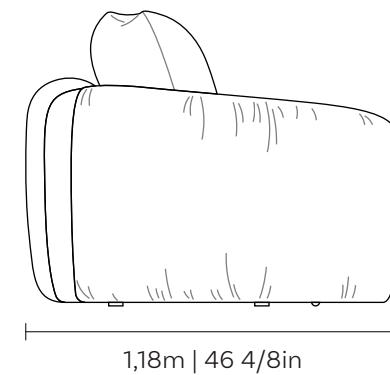
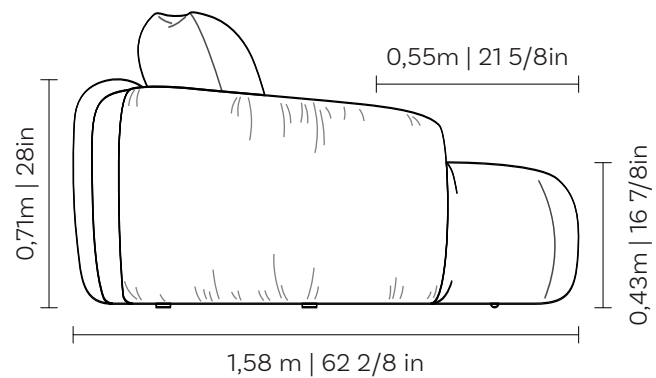
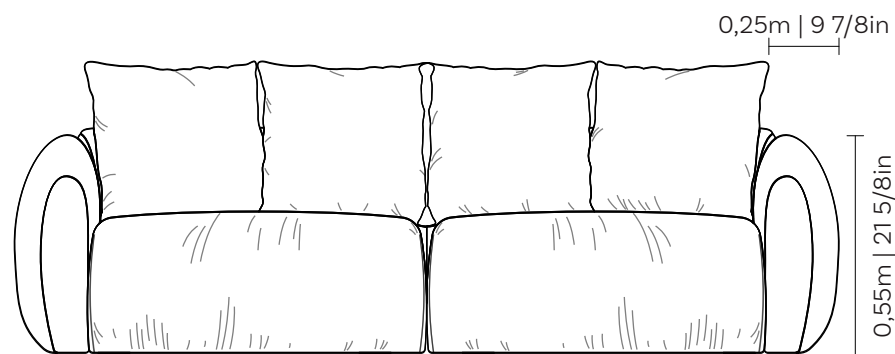

■ CAIXA

■ CORPO

sentido do tecido
das modulações

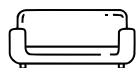

pontovírgula

Manifold

SOFÁS
SOFÁS | SOFÁS

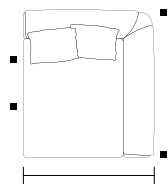

1B 1AS (D/E)	ASS	DEC
1,05 x 1,18 m 41 3/8 x 46 4/8 in	1	2
1,15 x 1,18 m 45 2/8 x 46 4/8 in	1	2
1,25 x 1,18 m 49 2/8 x 46 4/8 in	1	2
1,35 x 1,18 m 53 1/8 x 46 4/8 in	1	2
1,45 x 1,18 m 57 1/8 x 46 4/8 in	1	2

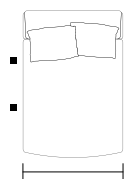

SB 1AS	ASS	DEC
0,80 x 1,18 m 31 4/8 x 46 4/8 in	1	2
0,90 x 1,18 m 35 3/8 x 46 4/8 in	1	2
1,00 x 1,18 m 39 3/8 x 46 4/8 in	1	2
1,10 x 1,18 m 43 2/8 x 46 4/8 in	1	2
1,20 x 1,18 m 47 2/8 x 46 4/8 in	1	2

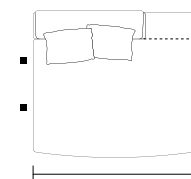

SB BI (D/E)	ASS	DEC
1,30 x 1,18 m 51 1/8 x 46 4/8 in	1	2
1,40 x 1,18 m 55 1/8 x 46 4/8 in	1	2
1,50 x 1,18 m 59 x 46 4/8 in	1	2
1,60 x 1,18 m 63 x 46 4/8 in	1	2
1,70 x 1,18 m 66 7/8 x 46 4/8 in	1	2

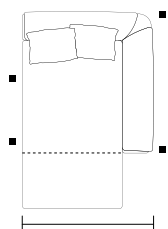

CH 1B (D/E)	ASS	DEC
1,05 x 1,58 m 41 3/8 x 62 2/8 in	1	2
1,15 x 1,58 m 45 2/8 x 62 2/8 in	1	2
1,25 x 1,58 m 49 2/8 x 62 2/8 in	1	2
1,35 x 1,58 m 53 1/8 x 62 2/8 in	1	2
1,45 x 1,58 m 57 1/8 x 62 2/8 in	1	2

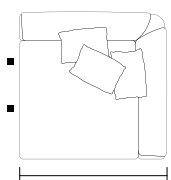

CTO	ASS	DEC
1,18 x 1,18 m 46 4/8 x 46 4/8 in	1	3

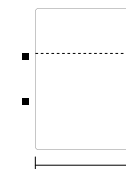

PUFF MEIO	ASS
0,80 x 1,13 m 31 4/8 x 44 4/8 in	1
0,90 x 1,13 m 35 3/8 x 44 4/8 in	1
1,00 x 1,13 m 39 3/8 x 44 4/8 in	1
1,10 x 1,13 m 43 2/8 x 44 4/8 in	1
1,20 x 1,13 m 47 2/8 x 44 4/8 in	1

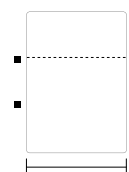

PUFF BI (D/E)	ASS
0,80 x 1,13 m 31 4/8 x 44 4/8 in	1
0,90 x 1,13 m 35 3/8 x 44 4/8 in	1
1,00 x 1,13 m 39 3/8 x 44 4/8 in	1
1,10 x 1,13 m 43 2/8 x 44 4/8 in	1
1,20 x 1,13 m 47 2/8 x 44 4/8 in	1

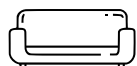

pontovírgula

Manifold

SOFÁS
SOFÁS | SOFÁS

Assento: retrátil, com abertura de 40cm, opção de abertura manual ou motorizada, com leve sobra de tecido e sem detalhe de costura.

Encosto: fixo, sem detalhe de costura.

Braço: fixo, sem detalhe de costura.

Almofada Decorativa: solta, sem detalhe de costura, com 75x65cm.

Suporte: pés em polipropileno injetado, na cor preta.

Medidas podem apresentar leves variações. Nos reservamos o direito de efetuar alterações sem consulta prévia.

Seat: retractable, with a 40 cm opening, option for manual or motorized operation, with slight fabric slack and no stitching detail.

Backrest: Fixed, without stitching details.

Armrest: Fixed, without stitching details.

Decorative Cushion: Loose, without stitching details, measuring 75 × 65 cm.

Support: Injected polypropylene feet, in black.

Measures may vary slightly. We reserve the right to make changes without prior consultation.

*For more information, see our Comfort Guide.

Asiento: retráctil, con abertura de 40 cm, opción de apertura manual o motorizada, con ligera holgura de tela y sin detalle de costura.

Respaldo: Fijo, sin detalles de costura.

Brazos: Fijos, sin detalles de costura.

Cojín Decorativo: Suelto, sin detalles de costura, de 75 × 65 cm.

Soporte: Patas de polipropileno inyectado, en color negro.

Las medidas pueden variar un poco. Nos reservamos el derecho de realizar cambios sin previa consulta.

*Para más informaciones, consulte nuestro Guía de Confort.

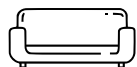

ponto**vírgula**

Modum



SOFÁS
SOFÁS | SOFÁS

ponto**vírgula**



Modum

SOFÁS
SOFÁS | SOFÁS

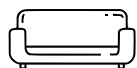

Modum

SOFÁS
SOFÁS | SOFÁS

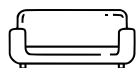
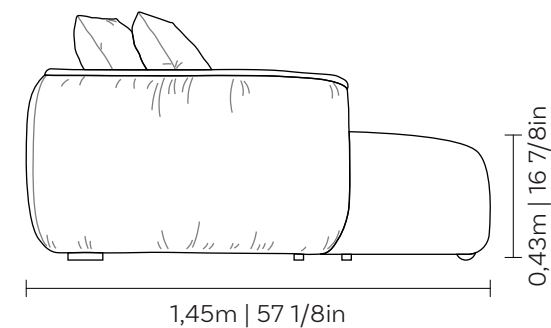
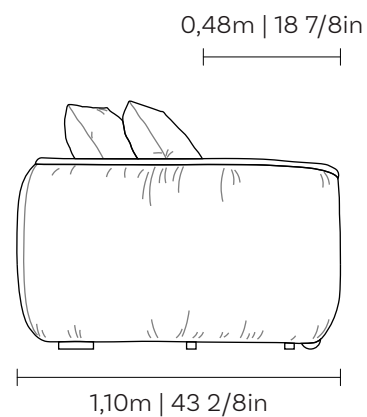
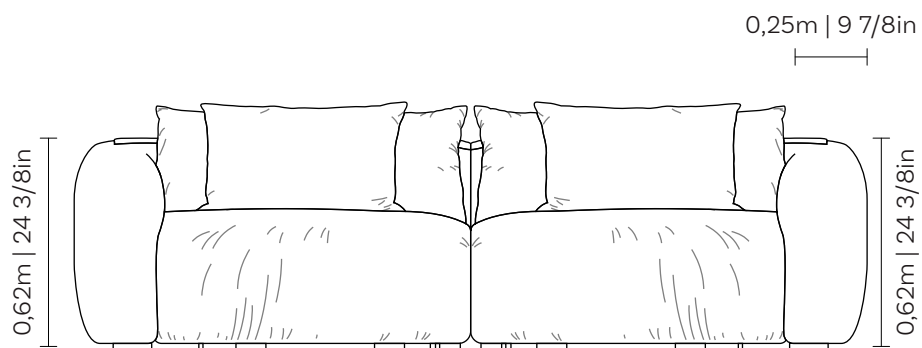

sentido do tecido
das modulações



ponto**vírgula**

Modum

SOFÁS
SOFÁS | SOFÁS

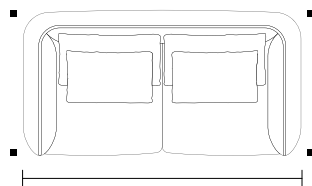

2B 1AS	ASS	ENC	DEC
2,10 x 1,10 m 82 5/8 x 43 2/8 in	2	2	2
2,30 x 1,10 m 90 4/8 x 43 2/8 in	2	2	2
2,50 x 1,10 m 98 3/8 x 43 2/8 in	2	2	2
2,70 x 1,10 m 106 2/8 x 43 2/8 in	2	2	2
2,90 x 1,10 m 114 1/8 x 43 2/8 in	2	2	2

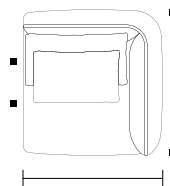

1B 1AS (D/E)	ASS	ENC	DEC
1,05 x 1,10 m 41 3/8 x 43 2/8 in	2	2	2
1,15 x 1,10 m 45 2/8 x 43 2/8 in	2	2	2
1,25 x 1,10 m 49 2/8 x 43 2/8 in	2	2	2
1,35 x 1,10 m 53 1/8 x 43 2/8 in	2	2	2
1,45 x 1,10 m 57 1/8 x 43 2/8 in	2	2	2

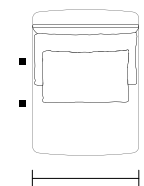

SB 1AS (D/E)	ASS	ENC	DEC
0,80 x 1,10 m 31 4/8 x 43 2/8 in	1	1	1
0,90 x 1,10 m 35 3/8 x 43 2/8 in	1	1	1
1,00 x 1,10 m 39 3/8 x 43 2/8 in	1	1	1
1,10 x 1,10 m 43 2/8 x 43 2/8 in	1	1	1
1,20 x 1,10 m 47 2/8 x 43 2/8 in	1	1	1

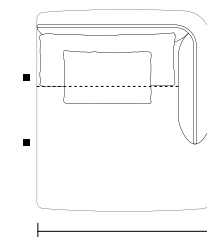

CH 1B (D/E)	ASS	ENC	DEC
1,05 x 1,45 m 41 3/8 x 57 1/8 in	1	1	1
1,15 x 1,45 m 45 2/8 x 57 1/8 in	1	1	1
1,25 x 1,45 m 49 2/8 x 57 1/8 in	1	1	1
1,35 x 1,45 m 53 1/8 x 57 1/8 in	1	1	1
1,45 x 1,45 m 57 1/8 x 57 1/8 in	1	1	1

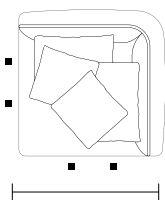

CTO	ASS	ENC	DEC
1,10 x 1,10 m 43 2/8 x 43 2/8 in	1	2	2

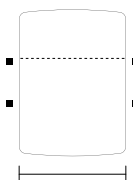

PUFF MEIO	ASS
0,80 x 1,10 m 31 4/8 x 43 2/8 in	1
0,90 x 1,10 m 35 3/8 x 43 2/8 in	1
1,00 x 1,10 m 39 3/8 x 43 2/8 in	1
1,10 x 1,10 m 43 2/8 x 43 2/8 in	1
1,20 x 1,10 m 47 2/8 x 43 2/8 in	1

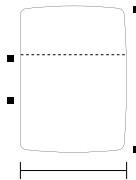

PUFF BI (D/E)	ASS
0,80 x 1,10 m 31 4/8 x 43 2/8 in	1
0,90 x 1,10 m 35 3/8 x 43 2/8 in	1
1,00 x 1,10 m 39 3/8 x 43 2/8 in	1
1,10 x 1,10 m 43 2/8 x 43 2/8 in	1
1,20 x 1,10 m 47 2/8 x 43 2/8 in	1

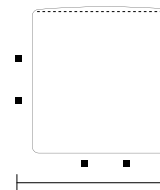

PUFF CTO	ASS	ENC	DEC
1,10 x 1,10 m 43 2/8 x 43 2/8 in	1	2	2

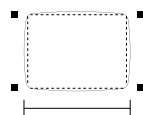

PUFF	ASS
0,80 x 0,60 m 31 4/8 x 23 5/8 in	1
0,90 x 0,60 m 35 3/8 x 23 5/8 in	1
1,00 x 0,60 m 39 3/8 x 23 5/8 in	1

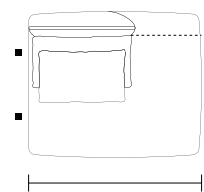

SBBI (D/E)	ASS	ENC	DEC
1,30 x 1,10 m 51 1/8 x 43 2/8 in	1	1	1
1,40 x 1,10 m 55 1/8 x 43 2/8 in	1	1	1
1,50 x 1,10 m 59 x 43 2/8 in	1	1	1
1,60 x 1,10 m 63 x 43 2/8 in	1	1	1
1,70 x 1,10 m 66 7/8 x 43 2/8 in	1	1	1

sentido do tecido das modulações

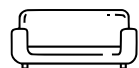

Modum

SOFÁS
SOFÁS | SOFÁS

Assento: retrátil, com opção de manual e motorizado, com abertura de 35cm, sem detalhe de costura.

Encosto: fixo, com costura em fole de 2,5cm.

Braço: fixo, com costura em fole de 2,5cm.

Almofada de Encosto: solta, com opção de aberta e fechada, sem detalhe de costura, com altura de 55cm.

Almofada Decorativa: solta, sem detalhe de costura, com 65x55cm.

Suporte: pés em polipropileno injetado, na cor preta.

Medidas podem apresentar leves variações. Nos reservamos o direito de efetuar alterações sem consulta prévia.

Seat: retractable, with manual or motorized option, 35 cm opening, no stitching detail.

Backrest: Fixed, with 2.5 cm pleated stitching.

Armrest: Fixed, with 2.5 cm pleated stitching.

Back cushion: loose, with open or closed option, no stitching detail, 55 cm height.

Decorative Cushion: Loose, without stitching details, measuring 65 x 55 cm.

Support: Injected polypropylene feet, in black.

Measures may vary slightly. We reserve the right to make changes without prior consultation.

*For more information, see our Comfort Guide.

Asiento: retráctil, con opción manual o motorizada, apertura de 35 cm, sin detalle de costura.

Respaldo: Fijo, con costura en pliegue de 2,5 cm.

Brazos: Fijos, con costura en pliegue de 2,5 cm.

Cojín de respaldo: suelto, con opción abierta o cerrada, sin detalle de costura, altura de 55 cm.

Cojín Decorativo: Suelto, sin detalles de costura, de 65 x 55 cm.

Soporte: Patas de polipropileno inyectado, en color negro.

Las medidas pueden variar un poco. Nos reservamos el derecho de realizar cambios sin previa consulta.

*Para más informaciones, consulte nuestro Guía de Confort.

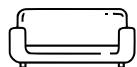

pontovírgula

Nimbus



SOFÁS
SOFAS | SOFÁS

ponto**vírgula**



Nimbus

SOFÁS
SOFAS | SOFÁS

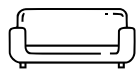

Nimbus

SOFÁS
SOFAS | SOFÁS

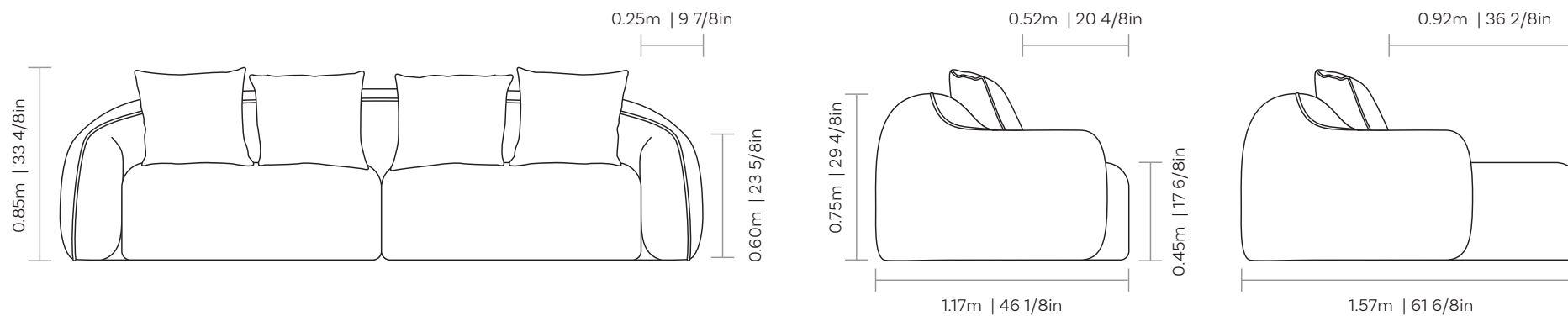

Assento retrátil sem detalhe de costura, com abertura de 40cm e opção de abertura manual ou motorizado. Almofada decorativa solta 55x55cm com costura em debrum composê. Encosto e braços fixos com costura em debrum composê. Pés em polipropileno injetado na cor preta.

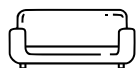

Nimbus

SOFÁS
SOFAS | SOFÁS

2 BRAÇOS 2 ASSENTOS
(MANUAL E MOTOR)

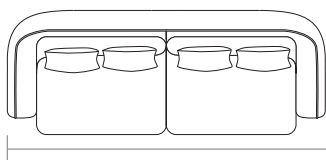

DIMENSÕES		ALMOFADAS
DIMENSIONS DIMENSIONES		CUSHIONS COJINES
2.00m x 1.17m	78 6/8in x 46 1/8in	4
2.20m x 1.17m	86 5/8in x 46 1/8in	4
2.40m x 1.17m	94 4/8in x 46 1/8in	4
2.60m x 1.17m	102 3/8in x 46 1/8in	6
2.80m x 1.17m	110 2/8in x 46 1/8in	6
3.00m x 1.17m	118 1/8in x 46 1/8in	6

1 BRAÇO 1 ASSENTO
(MANUAL E MOTOR)

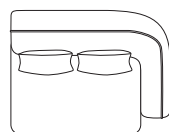

DIMENSÕES		ALMOFADAS
DIMENSIONS DIMENSIONES		CUSHIONS COJINES
1.00m x 1.17m	39 3/8in x 46 1/8in	2
1.10m x 1.17m	43 2/8in x 46 1/8in	2
1.20m x 1.17m	47 2/8in x 46 1/8in	2
1.30m x 1.17m	51 1/8in x 46 1/8in	3
1.40m x 1.17m	55 1/8in x 46 1/8in	3
1.50m x 1.17m	59in x 46 1/8in	3

SEM BRAÇO 1 ASSENTO
(MANUAL E MOTOR)



DIMENSÕES		ALMOFADAS
DIMENSIONS DIMENSIONES		CUSHIONS COJINES
0.75m x 1.17m	29 4/8in x 46 1/8in	2
0.85m x 1.17m	33 4/8in x 46 1/8in	2
0.95m x 1.17m	37 3/8in x 46 1/8in	2
1.05m x 1.17m	41 3/8in x 46 1/8in	3
1.15m x 1.17m	45 2/8in x 46 1/8in	3
1.25m x 1.17m	49 2/8in x 46 1/8in	3

CANTO (C/O)

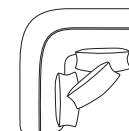

DIMENSÕES		ENCOSTO
DIMENSIONS DIMENSIONES		BACKREST RESPALDO
1.17m x 1.17m	78 6/8in x 46 1/8in	3

SEM BRAÇO 1 ASSENTO BI

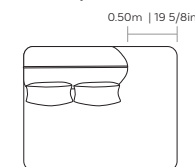

DIMENSÕES		ALMOFADAS
DIMENSIONS DIMENSIONES		CUSHIONS COJINES
1.25m x 1.17m	49 2/8in x 46 1/8in	2
1.35m x 1.17m	53 1/8in x 46 1/8in	2
1.45m x 1.17m	57 1/8in x 46 1/8in	2
1.55m x 1.17m	61in x 46 1/8in	3
1.65m x 1.17m	65in x 46 1/8in	3
1.75m x 1.17m	68 7/8in x 46 1/8in	3

Oasi



SOFÁS
SOFÁS | SOFÁS

ponto**vírgula**



Oasi

SOFÁS
SOFÁS | SOFÁS

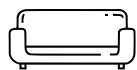

Oasi

SOFÁS
SOFÁS | SOFÁS

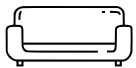
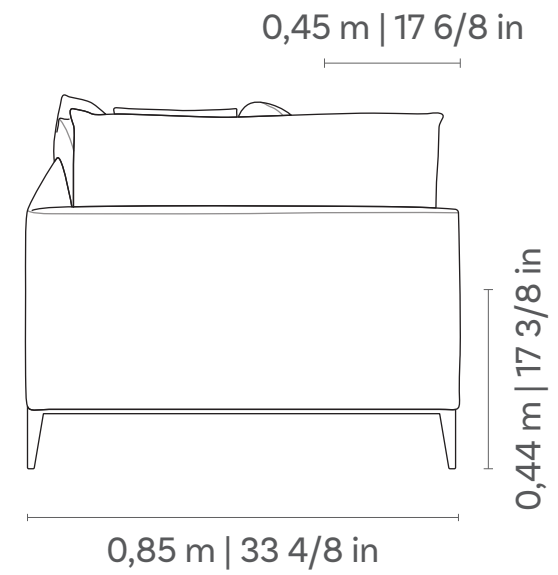
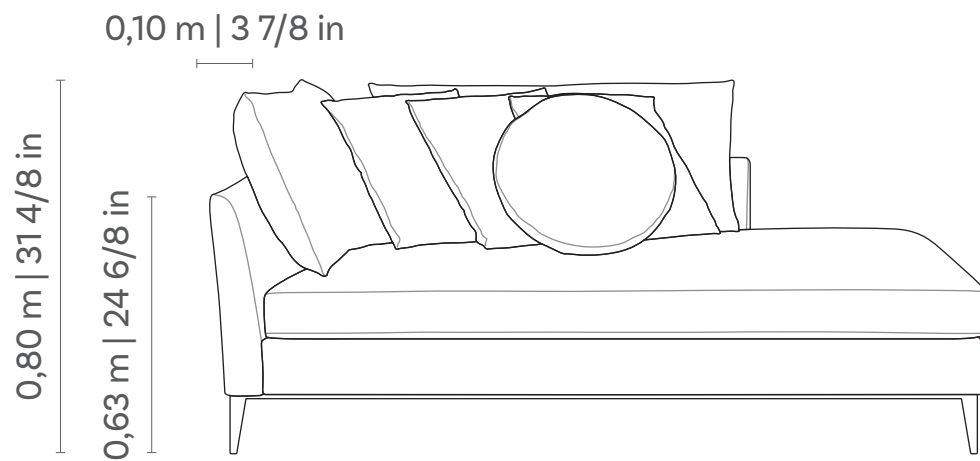

Oasi

SOFÁS
SOFÁS | SOFÁS

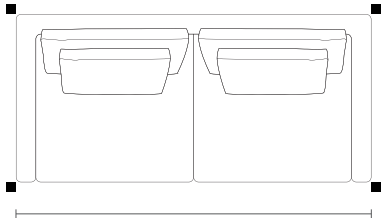

2B2	ASS	DEC	ENC
1,80 m 70 7/8 in	2	2	2
2,00 m 78 6/8 in	2	2	2
2,20 m 86 5/8 in	2	2	2
2,40 m 94 4/8 in	2	2	2
2,60 m 102 3/8 in	2	2	2
2,80 m 110 2/8 in	2	2	2
3,00 m 118 1/8 in	2	2	2

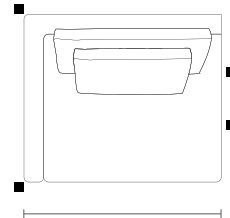

1B1	ASS	DEC	ENC
1,00 m 39 3/8 in	1	1	1
1,10 m 43 2/8 in	1	1	1
1,20 m 47 2/8 in	1	1	1
1,30 m 51 1/8 in	1	1	1
1,40 m 55 1/8 in	1	1	1
1,50 m 59 in	1	1	1

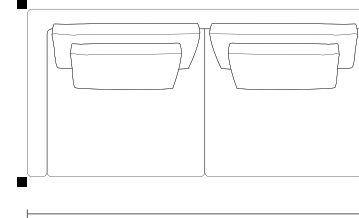

1B2 (D/E)	ASS	DEC	ENC
1,70 m 66 7/8 in	2	2	2
1,90 m 74 6/8 in	2	2	2
2,10 m 82 5/8 in	2	2	2
2,30 m 90 4/8 in	2	2	2
2,50 m 98 3/8 in	2	2	2
2,70 m 106 2/8 in	2	2	2

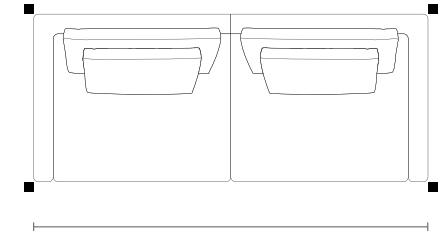

1B+1B	ASS	DEC	ENC
1,00 + 1,00 m 39 3/8 + 39 3/8 in	2	2	2
1,10 + 1,10 m 43 2/8 + 43 2/8 in	2	2	2
1,20 + 1,20 m 47 2/8 + 47 2/8 in	2	2	2
1,30 + 1,30 m 51 1/8 + 51 1/8 in	2	2	2
1,40 + 1,40 m 55 1/8 + 55 1/8 in	2	2	2
1,50 + 1,50 m 59 + 59 in	2	2	2

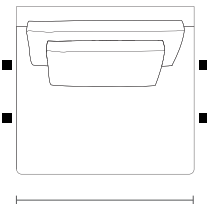

SB1	ASS	DEC	ENC
0,90 m 35 3/8 in	1	1	1
1,00 m 39 3/8 in	1	1	1
1,10 m 43 2/8 in	1	1	1
1,20 m 47 2/8 in	1	1	1
1,30 m 51 1/8 in	1	1	1
1,40 m 55 1/8 in	1	1	1

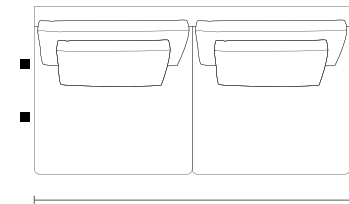

SB2	ASS	DEC	ENC
1,60 m 63 in	2	2	2
1,80 m 70 7/8 in	2	2	2
2,00 m 78 6/8 in	2	2	2
2,20 m 86 5/8 in	2	2	2
2,40 m 94 4/8 in	2	2	2
2,60 m 102 3/8 in	2	2	2

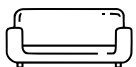

Oasi

SOFÁS
SOFÁS | SOFÁS

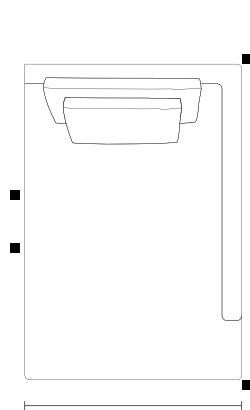

CH 1B	ASS	DEC	ENC
1,10 x 1,60 m 43 2/8 x 63 in	1	1	1
1,20 x 1,60 m 47 2/8 x 63 in	1	1	1
1,30 x 1,60 m 51 1/8 x 63 in	1	1	1
1,40 x 1,60 m 55 1/8 x 63 in	1	1	1

0,85 m | 33 4/8 in

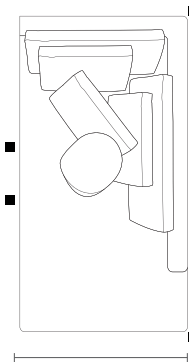

CH AV	ASS	ENC	DEC (QUA)	DEC (RED)
0,85 x 1,60 m 33 4/8 x 63 in	1	2	3	1
0,85 x 1,80 m 33 4/8 x 70 7/8 in	1	2	3	1
0,85 x 2,00 m 33 4/8 x 78 6/8 in	1	2	4	1
1,05 x 1,60 m 41 3/8 x 63 in	1	2	3	1
1,05 x 1,80 m 41 3/8 x 70 7/8 in	1	2	3	1
1,05 x 2,00 m 41 3/8 x 78 6/8	1	2	4	1

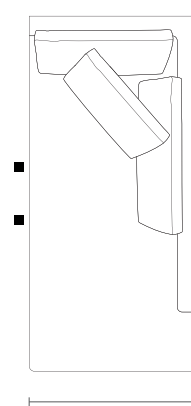

CH AV	ASS	ENC	DEC
0,85 x 1,80 m 33 4/8 x	1	2	1
0,85 x 1,90 m 33 4/8 x	1	2	1
0,85 x 2,00 m 33 4/8 x	1	2	1
0,85 x 2,10 m 33 4/8 x	1	2	1
0,85 x 2,20 m 33 4/8 x	1	2	1
0,85 x 2,30 m 33 4/8 x	1	2	1
0,85 x 2,40 m 33 4/8 x	1	2	1

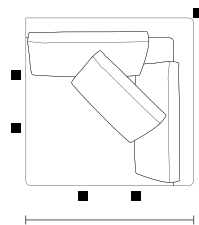

CTO	ASS	DEC	ENC
0,85 x 0,85 m 33 4/8 x 33 4/8 in	1	2	1



PUFF
0,90 x 0,75 m 35 3/8 x 29 4/8 in
1,00 x 0,75 m 39 3/8 x 29 4/8 in
1,10 x 0,75 m 43 2/8 x 29 4/8 in
1,20 x 0,75 m 47 2/8 x 29 4/8 in
1,30 x 0,75 m 51 1/8 x 29 4/8 in
1,40 x 0,75 m 55 1/8 x 29 4/8 in

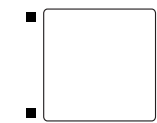

PUFF CTO	ASS	DEC	ENC
0,85 x 0,85 m 33 4/8 x 33 4/8 in	1	2	1

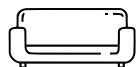

Oasi

SOFÁS
SOFÁS | SOFÁS

Assento fixo sem detalhe de costura. Encosto e braços fixos em pesponto simples e leve inclinação para fora. Almofada de assento fixa com costura em pesponto simples. Almofada de encosto solta sem detalhe de costura. Decorativa redonda com costura em pesponto simples. Decorativa quadrada sem detalhe de costura. Base aço carbono com pintura MTX e metalizada.

Medidas podem apresentar leves variações. Nos reservamos o direito de efetuar alterações sem consulta prévia.

Fixed seat. Backrest and arms fixed in simple backstitch and slightly tilted out. Seat cushion fixed in simple topstitching. Loose back cushion. Round decorative with simple topstitching. Square decorative. Carbon steel base with MTX paint and metallized.

Measures may vary slightly. We reserve the right to make changes without prior consultation.

Asiento fijo. Respaldo y brazos fijados en pespunte simple y ligeramente inclinados hacia afuera. Cojín de asiento fijado en pespuntos sencillos. Cojín de respaldo suelto. Decorativo redondo con pespuntos sencillos. Cuadrado decorativo. Base de acero al carbono con pintura MTXy metalizada.

Las medidas pueden variar un poco. Nos reservamos el derecho de realizar cambios sin previa consulta.

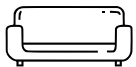

ponto**vírgula**

Otte



SOFÁS
SOFÁS | SOFÁS

ponto**vírgula**



Otte

SOFÁS
SOFÁS | SOFÁS

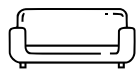

pontovirgula

Otte

SOFÁS
SOFÁS | SOFÁS

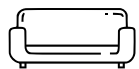
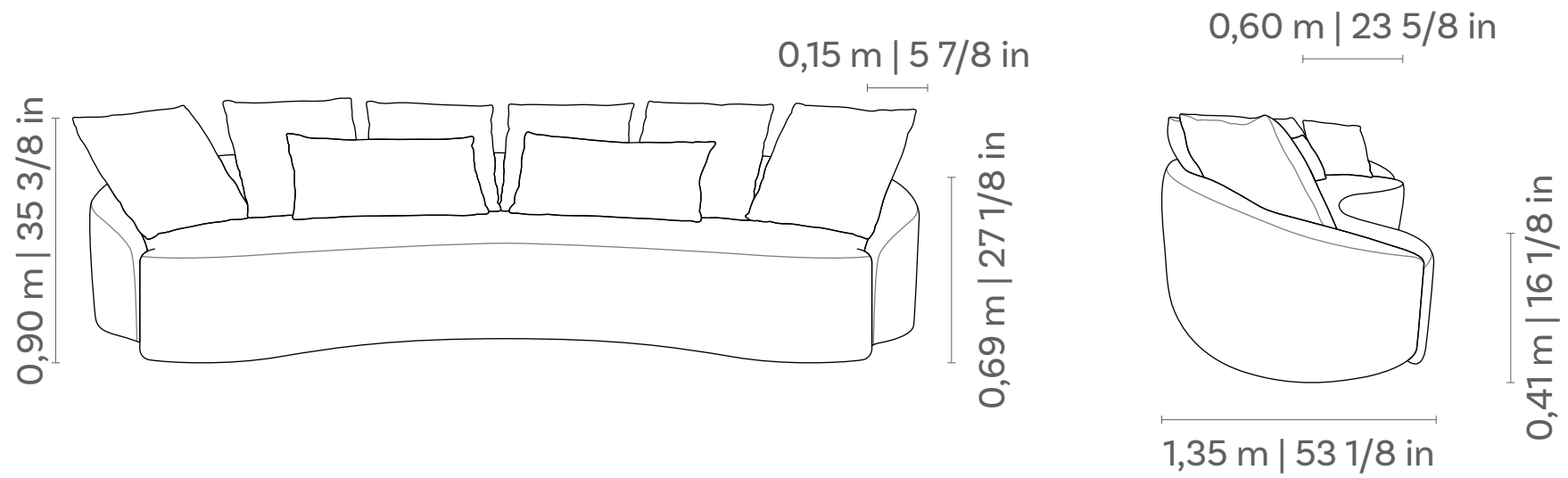

Otte

SOFÁS
SOFÁS | SOFÁS

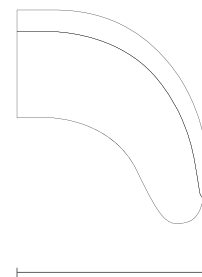
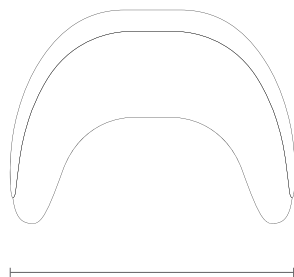

2B1	ENC	LOMB
1,80 m 70 7/8 in	4	2
2,00 m 78 6/8 in	4	2
2,20 m 86 5/8 in	4	2
2,40 m 94 4/8 in	4	2
2,60 m 102 3/8 in	6	2
2,80 m 110 2/8 in	6	2
3,00 m 118 1/8 in	6	2
3,20 m 126 in	6	2
3,40 m 133 7/8 in	6	2
3,60 m 141 6/8 in	8	2

1B1 (D/E)	ENC	LOMB
1,20 m 47 2/8 in	2	1
1,30 m 51 1/8 in	3	1
1,40 m 55 1/8 in	3	1
1,50 m 59 in	3	1
1,60 m 63 in	3	1
1,70 m 66 7/8 in	3	1
1,80 m 70 7/8 in	4	1
1,90 m 74" in	4	1
2,00 m 78 6/8 in	6	1

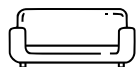

Otte

SOFÁS
SOFÁS | SOFÁS

Assento com almofada fixa costurada em pesponto simples. Encosto fixo com costura em pesponto simples. Almofadas complementares decorativa 55x55cm com costura em pesponto simples e lombar 40cm de altura sem detalhe de costura. Suporte pés em polipropileno injetado.

Medidas podem apresentar leves variações. Nos reservamos o direito de efetuar alterações sem consulta prévia.

Seat with fixed cushion in simple topstitching. Backrest fixed in simple topstitching. Complementary decorative pillows 55x55cm with simple and lumbar top 40cm. Foot support in injected polypropylene.

Measures may vary slightly. We reserve the right to make changes without prior consultation.

*For more information, see our Comfort Guide.

Asiento con cojín fijo en pespuntos sencillos. Respaldo fijado en pespuntos sencillos. Cojines decorativos complementarios 55x55cm con top simple y lumbar 40cm. Reposapiés en polipropileno inyectado.

Las medidas pueden variar un poco. Nos reservamos el derecho de realizar cambios sin previa consulta.

*Para más informaciones, consulte nuestro Guía de Confort.

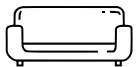

PASS

sofá articulado



ponto **vírgula**

PASS

sofá articulado

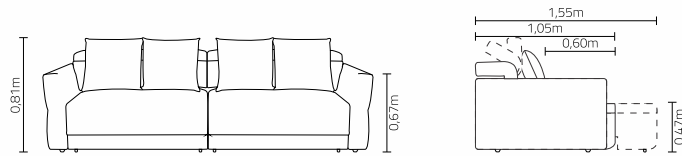

Opção de largura do braço:
0,10cm | 0,15cm | 0,20cm | 0,25cm

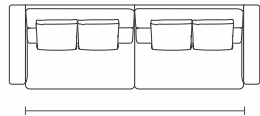

2B2	ASS	ENC	BRA
1,30 m	2	2	2
1,50 m	2	2	2
1,70 m	2	2	2
1,90 m	2	2	2
2,10 m	2	2	2
2,30 m	2	2	2

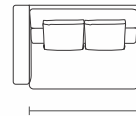

1B1 (E/D)	ASS	ENC	BRA
0,65 m	1	1	1
0,75 m	1	1	1
0,85 m	1	1	1
0,95 m	1	1	1
1,05 m	1	1	1
1,15 m	1	1	1



SB	ASS
0,65 m	1
0,75 m	1
0,85 m	1
0,95 m	1
1,05 m	1
1,15 m	1

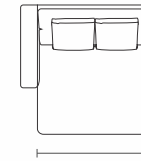

CH (E/D)	ASS	ENC	BRA
0,65 x 1,55m	1	1	1
0,75 x 1,55m	1	1	1
0,85 x 1,55m	1	1	1
0,95 x 1,55m	1	1	1
1,05 x 1,55m	1	1	1
1,15 x 1,55m	1	1	1

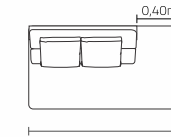

SBB(E/D)	ASS	ENC
1,05 m	1	1
1,15 m	1	1
1,25 m	1	1
1,35 m	1	1
1,45 m	1	1
1,55 m	1	1

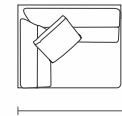

CTO	ASS	ENC	BRA
1,05 x 1,05 m	1	1	1

Assento retrátil com abertura de 50cm. Almofada de assento fixa, encosto reclinável com costura em pesponto simples. Almofada decorativa 55 x 55cm sem detalhe de costura. Pés em polipropileno injetado.

Retractable seat with a 50 cm opening. Fixed seat cushion, reclining backrest with simple stitching. Decorative pillow 55 x 55cm without sewing details. Feet in injected polypropylene.

Asiento retráctil con una apertura de 50 cm. Cojín de asiento fijo, respaldo reclinable con costura simple. Cojín decorativo 55 x 55cm sin detalles de costura. Pies en polipropileno inyectado.



PASS

sofá articulado

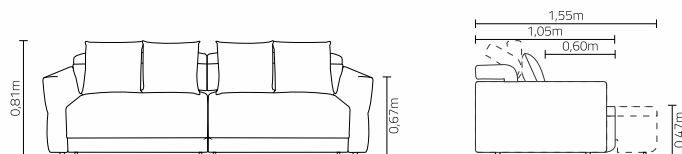

Opção de largura do braço:
0,10cm | 0,15cm | 0,20cm | 0,25cm



PUFF CTO ASS
1,05 x 1,05 m 1



PUFF ASS
0,75 X 0,60 m 1
0,85 X 0,60 m 1
0,95 X 0,60 m 1
1,05 X 0,60 m 1

Assento retrátil com abertura de 50cm. Almofada de assento fixa, encosto reclinável com costura em pesponto simples. Almofada decorativa 55 x 55cm sem detalhe de costura. Pés em polipropileno injetado.

Retractable seat with a 50 cm opening. Fixed seat cushion, reclining backrest with simple stitching. Decorative pillow 55 x 55cm without sewing details. Feet in injected polypropylene.

Asiento retráctil con una abertura de 50 cm. Cojín de asiento fijo, respaldo reclinable con costura simple. Cojín decorativo 55 x 55cm sin detalles de costura. Pies en polipropileno inyectado.



PRESLEY

sofá living



ponto **vírgula**

PRESLEY

sofá living

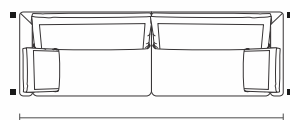
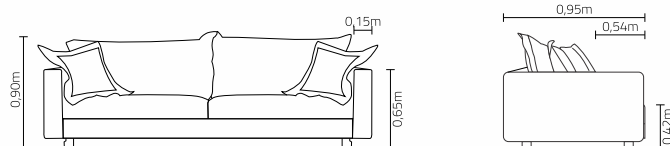

2B2	ASS	ENC	BRA
1,60 m	2	2	2
1,80 m	2	2	2
2,00 m	2	2	2
2,20 m	2	2	2
2,40 m	2	2	2
2,60 m	2	2	2
2,80 m	2	2	2

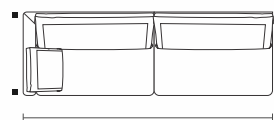

1B2 (D/E)	ASS	ENC	BRA
1,65 m	2	2	1
1,85 m	2	2	1
2,05 m	2	2	1
2,25 m	2	2	1

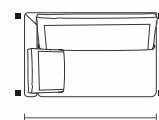

1B1 (D/E)	ASS	ENC	BRA
1,20 m	1	1	1
1,30 m	1	1	1
1,40 m	1	1	1
1,50 m	1	1	1
1,60 m	1	1	1

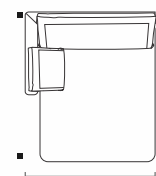

CH1B (D/E)	ASS	ENC	BRA
1,20 x 1,60 m	1	1	1
1,30 x 1,60 m	1	1	1

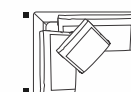

CTO	ASS	ENC	BRA
0,95 x 0,95	1	1	1



PUFF CTO
0,95 x 0,95 m

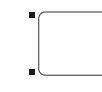

PUFF
0,70 x 0,60 m
0,80 x 0,60 m
0,90 x 0,60 m
1,00 x 0,60 m

Assento, almofada de assento, encosto e braço fixos com costura em pesponto simples. Almofada de encosto e de braços soltas com costura em fole de 7cm. Pés em madeira disponíveis no acabamento pintura verniz.

Seat, seat cushion, backrest and armrest fixed with simple stitching. Loose backrest and armrest cushion with 7cm bellows stitching. Wooden feet available in varnish painting finish.

Asiento, cojín de asiento, respaldo y reposabrazos fijados con costura simple. Cojín de respaldo y reposabrazos suelto con costuras de fuelle de 7 cm. Pies de madera disponibles en acabado pintura barniz.



Prouvé



SOFÁS
SOFÁS | SOFÁS

ponto**vírgula**



Prouvé

SOFÁS
SOFÁS | SOFÁS

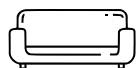

pontovírgula

Prouvé

SOFÁS
SOFÁS | SOFÁS

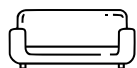
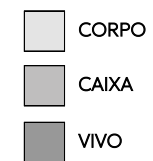
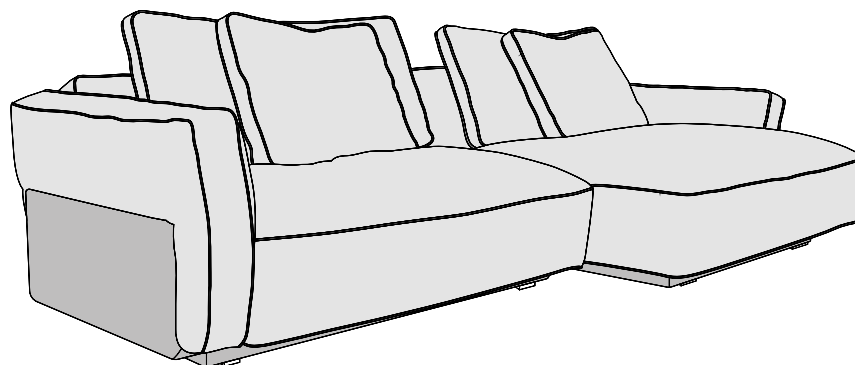
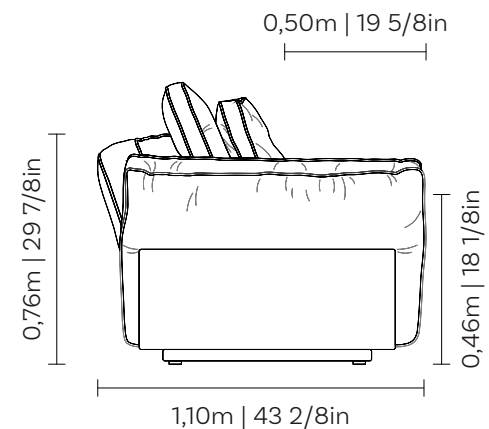
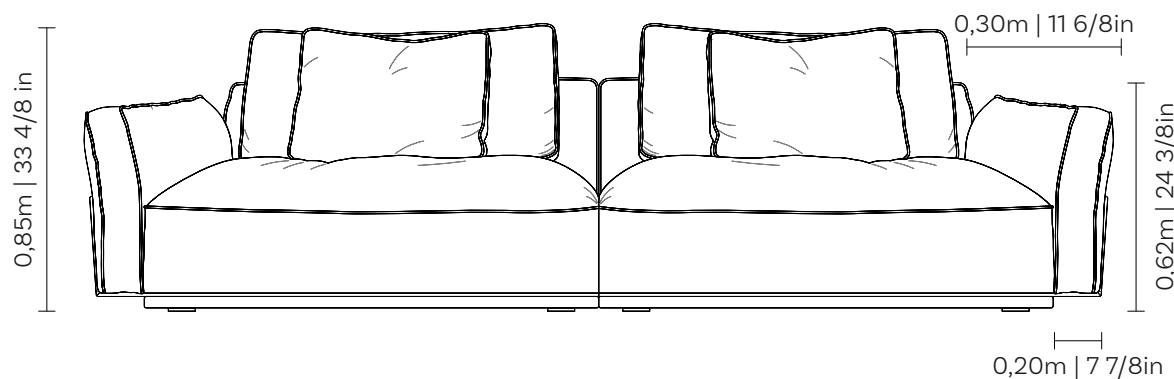

pontovírgula

Prouvé

SOFÁS
SOFÁS | SOFÁS

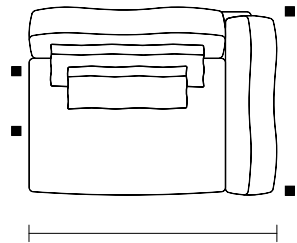

1B 1AS (D/E)	ASS	ENC	DEC
1,15 x 1,10 m 45 2/8 x 43 2/8 in	1	1	1
1,25 x 1,10 m 49 2/8 x 43 2/8 in	1	1	1
1,35 x 1,10 m 53 1/8 x 43 2/8 in	1	1	1
1,45 x 1,10 m 57 1/8 x 43 2/8 in	1	1	1
1,55 x 1,10 m 61 x 43 2/8 in	1	1	1
1,65 x 1,10 m 65 x 43 2/8 in	1	1	1
1,75 x 1,10 m 68 7/8 x 43 2/8 in	1	1	1

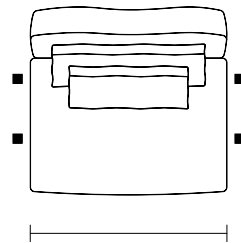

SB 1AS	ASS	ENC	DEC
0,95 x 1,10 m 37 3/8 x 43 2/8 in	1	1	1
1,05 x 1,10 m 41 3/8 x 43 2/8 in	1	1	1
1,15 x 1,10 m 45 2/8 x 43 2/8 in	1	1	1
1,25 x 1,10 m 49 2/8 x 43 2/8 in	1	1	1
1,35 x 1,10 m 53 1/8 x 43 2/8 in	1	1	1
1,45 x 1,10 m 57 1/8 x 43 2/8 in	1	1	1
1,55 x 1,10 m 61 x 43 2/8 in	1	1	1

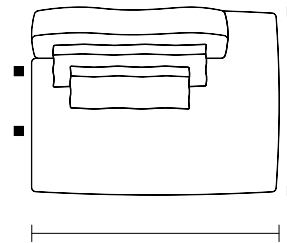

SB BI (D/E)	ASS	ENC	DEC
1,45 x 1,10 m 57 1/8 x 43 2/8 in	1	1	1
1,55 x 1,10 m 61 x 43 2/8 in	1	1	1
1,65 x 1,10 m 65 x 43 2/8 in	1	1	1
1,75 x 1,10 m 68 7/8 x 43 2/8 in	1	1	1
1,85 x 1,10 m 72 7/8 x 43 2/8 in	1	1	1
1,95 x 1,10 m 76 6/8 x 43 2/8 in	1	1	1
2,05 x 1,10 m 80 6/8 x 43 2/8 in	1	1	1

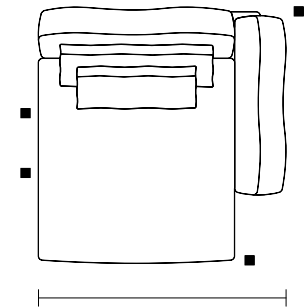

CH 1B (D/E)	ASS	ENC	DEC
1,15 x 1,50 m 45 2/8 x 59 in	1	1	1
1,25 x 1,50 m 49 2/8 x 59 in	1	1	1
1,35 x 1,50 m 53 1/8 x 59 in	1	1	1
1,45 x 1,50 m 57 1/8 x 59 in	1	1	1
1,55 x 1,50 m 61 x 59 in	1	1	1
1,65 x 1,50 m 65 x 59 in	1	1	1
1,75 x 1,50 m 68 7/8 x 59 in	1	1	1

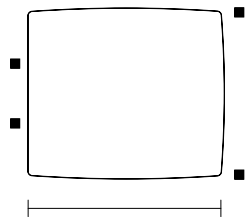

PUFF BI (D/E)	ASS
0,95 x 1,00 m 37 3/8 x 39 3/8 in	1
1,05 x 1,00 m 41 3/8 x 39 3/8 in	1
1,15 x 1,00 m 45 2/8 x 39 3/8 in	1
1,25 x 1,00 m 49 2/8 x 39 3/8 in	1
1,35 x 1,00 m 53 1/8 x 39 3/8 in	1
1,45 x 1,00 m 57 1/8 x 39 3/8 in	1
1,55 x 1,00 m 61 x 39 3/8 in	1

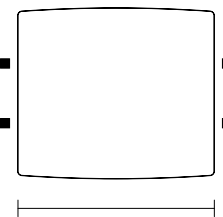

PUFF MEIO	ASS
0,95 x 1,00 m 37 3/8 x 39 3/8 in	1
1,05 x 1,00 m 41 3/8 x 39 3/8 in	1
1,15 x 1,00 m 45 2/8 x 39 3/8 in	1
1,25 x 1,00 m 49 2/8 x 39 3/8 in	1
1,35 x 1,00 m 53 1/8 x 39 3/8 in	1
1,45 x 1,00 m 57 1/8 x 39 3/8 in	1
1,55 x 1,00 m 61 x 39 3/8 in	1

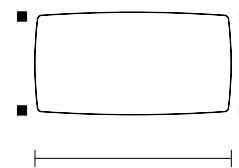

PUFF	ASS
0,95 x 0,60 m 37 3/8 x 23 5/8 in	1
1,05 x 0,60 m 41 3/8 x 23 5/8 in	1
1,15 x 0,60 m 45 2/8 x 23 5/8 in	1
1,25 x 0,60 m 49 2/8 x 23 5/8 in	1
1,35 x 0,60 m 53 1/8 x 23 5/8 in	1
1,45 x 0,60 m 57 1/8 x 23 5/8 in	1

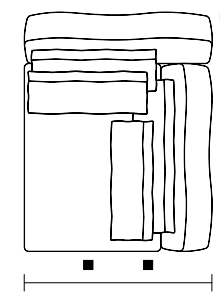

CTO (D/E) (ENC ATF)	ASS	ENC	DEC
1,10 x 1,40 m 43 2/8 x 55 1/8 in	1	2	2
1,10 x 1,60 m 43 2/8 x 63 in	1	2	2
1,10 x 1,80 m 43 2/8 x 70 7/8 in	1	2	2
1,10 x 2,00 m 43 2/8 x 78 6/8 in	1	3	3
1,10 x 2,20 m 43 2/8 x 86 5/8 in	1	3	3

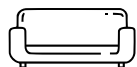

pontovírgula

Prouvé

SOFÁS
SOFÁS | SOFÁS

Assento: fixo, com costura em debrum composê.
Encosto: fixo, com costura em debrum composê.
Braço: fixo, com costura em debrum composê.
Almofada de assento: fixa, com costura em debrum composê.
Almofada de encosto: solta, com costura em debrum composê, com altura de 55cm.
Almofada decorativa: solta, com costura em debrum composê, com 70x55cm.
Suporte: pés em polipropileno injetado, na cor preta.

Medidas podem apresentar leves variações. Nos reservamos o direito de efetuar alterações sem consulta prévia.

Seat: fixed, with composê piping stitching.
Backrest: fixed, with composê piping stitching.
Arm: fixed, with composê piping stitching.
Seat cushion: fixed, with composê piping stitching.
Back cushion: loose, with composê piping stitching, 55 cm in height.
Decorative cushion: loose, with composê piping stitching, 70 x 55 cm.
Support: injected polypropylene feet, in black.

Measures may vary slightly. We reserve the right to make changes without prior consultation.

*For more information, see our Comfort Guide.

Asiento: fijo, con costura de ribete composê.
Respaldo: fijo, con costura de ribete composê.
Brazo: fijo, con costura de ribete composê.
Cojín de asiento: fijo, con costura de ribete composê.
Cojín de respaldo: suelto, con costura de ribete composê, con una altura de 55 cm.
Cojín decorativo: suelto, con costura de ribete composê, de 70 x 55 cm.
Soporte: patas de polipropileno inyectado, de color negro.

Las medidas pueden variar un poco. Nos reservamos el derecho de realizar cambios sin previa consulta.

*Para más informaciones, consulte nuestro Guía de Confort.

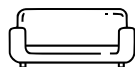

ponto**vírgula**

Quill



SOFÁS
SOFÁS | SOFÁS

ponto**vírgula**



Quill

SOFÁS ARTICULADOS
ARTICULATED SOFAS | SOFÁS ARTICULADOS

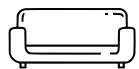

Quill

Sofá
cama

SOFÁS ARTICULADOS
ARTICULATED SOFAS | SOFÁS ARTICULADOS

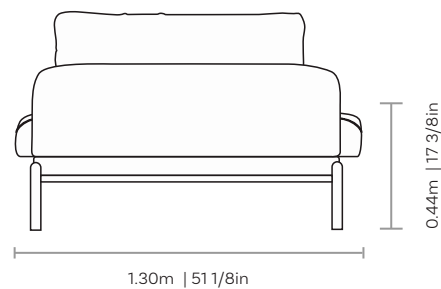
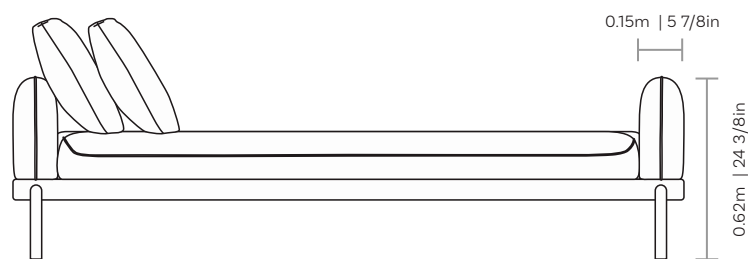
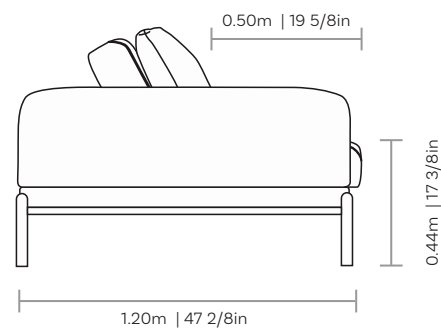
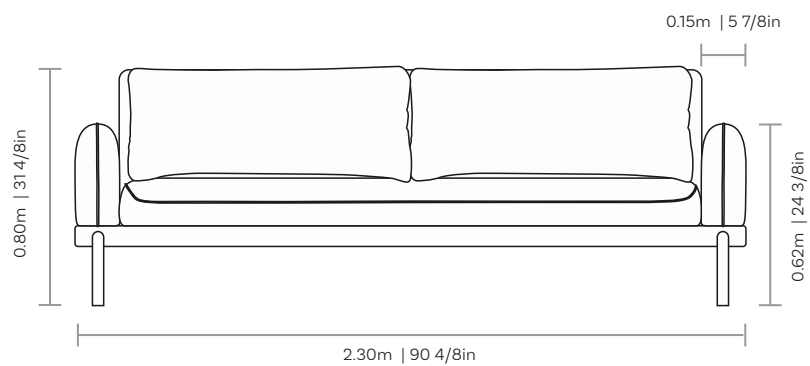

Assento e braços fixos, com costura em debrum composê. Almofada de assento com costura em debrum composê composta por espumas eco-espuma, D26 e D20 Soft, recobertas por manta siliconada. Encosto reclinável, com costura em debrum composê. Almofada de encosto solta, sem detalhe de costura, com opção de aberta ou fechada. Pés em aço carbono, com acabamentos em pintura MTX e metalizada.

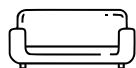

pontovírgula

Quill



SOFÁS ARTICULADOS
ARTICULATED SOFAS | SOFÁS ARTICULADOS

2 BRAÇOS 1 ASSENTO
2 ARMS 1 SEAT | 2 BRAZOS 1 ASIENTO

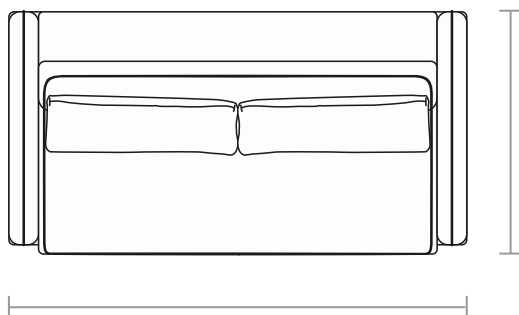

2 BRAÇOS 1 ASSENTO
2 ARMS 1 SEAT | 2 BRAZOS 1 ASIENTO

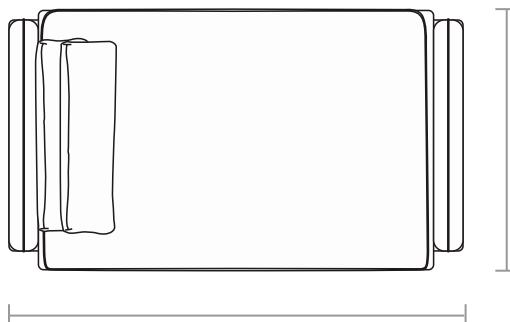

DIMENSÕES DIMENSIONS DIMENSIONES	ALMOFADAS CUSHIONS COJINES
2.20m x 1.20m 86 5/8in x 47 2/8	2
2.30m x 1.20m 90 4/8in x 47 2/8	2
2.40m x 1.20m 94 4/8in x 47 2/8	2
2.50m x 1.20m 98 3/8in x 47 2/8	2

DIMENSÕES DIMENSIONS DIMENSIONES	ALMOFADAS CUSHIONS COJINES
2.20m x 1.30m 86 5/8in x 51 1/8	2
2.30m x 1.30m 90 4/8in x 51 1/8	2
2.40m x 1.30m 94 4/8in x 51 1/8	2
2.50m x 1.30m 98 3/8in x 51 1/8	2

Assento e braços fixos, com costura em debrum composê. Almofada de assento com costura em debrum composê composta por espumas eco-espuma, D26 e D20 Soft, recobertas por manta siliconada. Encosto reclinável, com costura em debrum composê. Almofada de encosto solta, sem detalhe de costura, com opção de aberta ou fechada. Pés em aço carbono, com acabamentos em pintura MTX e metalizada.

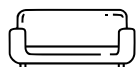

pontovírgula

System



SOFÁS
SOFÁS | SOFÁS

ponto**vírgula**
+
Persch Objects



System

SOFÁS
SOFÁS | SOFÁS

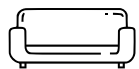

ponto**vírgula**
+
Persch Objects

System



SOFÁS
SOFÁS | SOFÁS

ponto**vírgula**
+
Persch Objects



System

SOFÁS
SOFÁS | SOFÁS

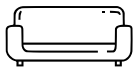

ponto**vírgula**
+ Persch Objects

System

SOFÁS
SOFÁS | SOFÁS

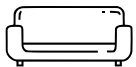
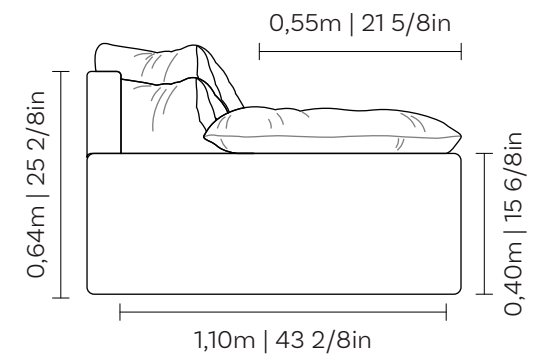
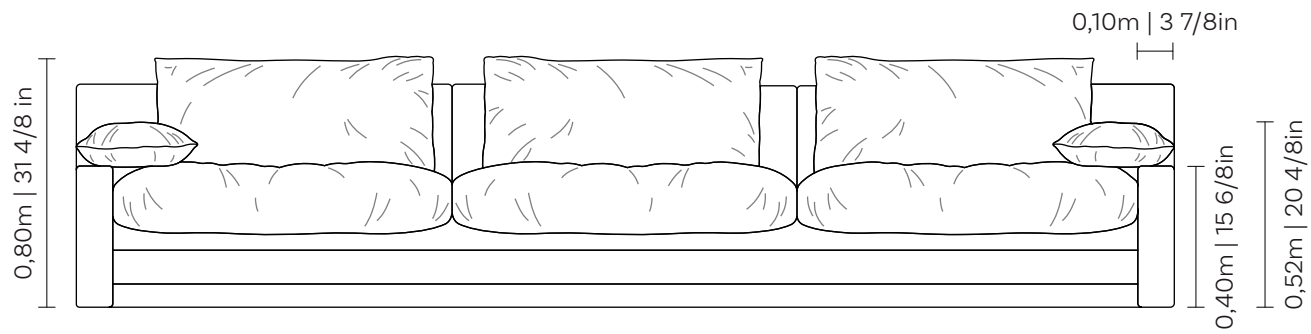

ponto **vírgula**
+ Persch Objects

System

SOFÁS
SOFÁS | SOFÁS

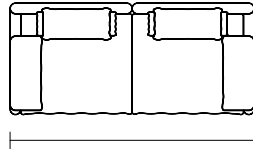

	ASS	ENC	LOMB	BRAÇO
1B 1AS + 1B 1AS				
1,05 + 1,05 x 1,05 m 41 3/8 + 41 3/8 x 41 3/8 in	2	2	2	2
1,15 + 1,15 x 1,05 m 45 2/8 + 45 2/8 x 41 3/8 in	2	2	2	2
1,25 + 1,25 x 1,05 m 49 2/8 + 49 2/8 x 41 3/8 in	2	2	2	2
1,35 + 1,35 x 1,05 m 53 1/8 + 53 1/8 x 41 3/8 in	2	2	2	2
1,45 + 1,45 x 1,05 m 57 1/8 + 57 1/8 x 41 3/8 in	2	2	2	2

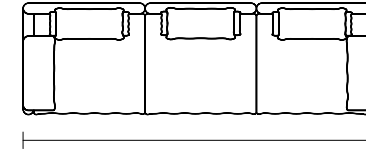

	ASS	ENC	LOMB	BRAÇO
1B 1AS + SB 1AS + 1B 1AS				
1,05 + 0,95 + 1,05 x 1,05 m 41 3/8 + 37 3/8 + 41 3/8 x 41 3/8 in	3	3	3	2
1,15 + 1,05 + 1,15 x 1,05 m 45 2/8 + 41 3/8 + 45 2/8 x 41 3/8 in	3	3	3	2

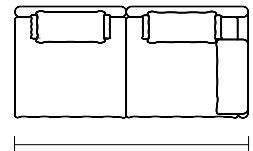

	ASS	ENC	LOMB	BRAÇO
1B 1AS + SB 1AS (D/E)				
1,05 + 0,95 x 1,05 m 37 3/8 + 37 3/8 x 41 3/8 in	2	2	2	2
1,15 + 1,05 x 1,05 m 41 3/8 + 41 3/8 x 41 3/8 in	2	2	2	2
1,25 + 1,15 x 1,05 m 45 2/8 + 45 2/8 x 41 3/8 in	2	2	2	2
1,35 + 1,25 x 1,05 m 49 2/8 + 49 2/8 x 41 3/8 in	2	2	2	2
1,45 + 1,35 x 1,05 m 53 1/8 + 53 1/8 x 41 3/8 in	2	2	2	2

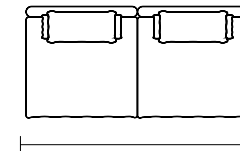

	ASS	ENC	LOMB
SB 1AS + SB 1AS			
0,95 + 0,95 x 1,05 m 37 3/8 + 37 3/8 x 41 3/8 in	2	2	2
1,05 + 1,05 x 1,05 m 41 3/8 + 41 3/8 x 41 3/8 in	2	2	2
1,15 + 1,15 x 1,05 m 45 2/8 + 45 2/8 x 41 3/8 in	2	2	2
1,25 + 1,25 x 1,05 m 49 2/8 + 49 2/8 x 41 3/8 in	2	2	2
1,35 + 1,35 x 1,05 m 53 1/8 + 53 1/8 x 41 3/8 in	2	2	2

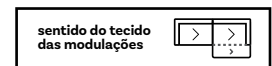
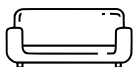

ponto**vírgula**
+ Persch Objects

System

SOFÁS
SOFÁS | SOFÁS

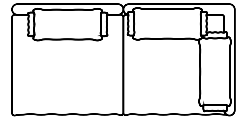

*Lado referenciado pelo lado sem braço

SB 1AS + CTO (D/E)	ASS	ENC	LOMB
0,95 + 1,05 x 1,05 m 37 3/8 + 41 3/8 x 41 3/8 in	2	2	2
1,05 + 1,05 x 1,05 m 41 3/8 + 41 3/8 x 41 3/8 in	2	2	2
1,15 + 1,05 x 1,05 m 45 2/8 + 41 3/8 x 41 3/8 in	2	2	2
1,25 + 1,05 x 1,05 m 49 2/8 + 41 3/8 x 41 3/8 in	2	2	2
1,35 + 1,05 x 1,05 m 53 1/8 + 41 3/8 x 41 3/8 in	2	2	2

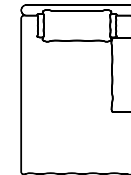

CH 1B (D/E)	ASS	ENC	LOMB	BRAÇO
1,05 x 1,60 m 41 3/8 x 63 in	1	1	1	1
1,15 x 1,60 m 45 2/8 x 63 in	1	1	1	1
1,25 x 1,60 m 49 2/8 x 63 in	1	1	1	1
1,35 x 1,60 m 53 1/8 x 63 in	1	1	1	1
1,45 x 1,60 m 57 1/8 x 63 in	1	1	1	1

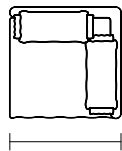

CTO	ASS	ENC	LOMB
1,05 x 1,05 m 41 3/8 x 41 3/8 in	1	2	2



PUFF CTO (ACS: AP)	ASS	ENC
1,05 x 1,05 m 41 3/8 x 41 3/8 in	1	2

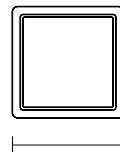

PUFF MEIO (ACS: AP)	ASS	ENC
0,95 x 1,05 m 37 3/8 x 41 3/8 in	1	1
1,05 x 1,05 m 41 3/8 x 41 3/8 in	1	1
1,15 x 1,05 m 45 2/8 x 41 3/8 in	1	1
1,25 x 1,05 m 49 2/8 x 41 3/8 in	1	1
1,35 x 1,05 m 53 1/8 x 41 3/8 in	1	1

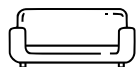

ponto **virgula**
+ Persch Objects

System

SOFÁS
SOFÁS | SOFÁS

Assento: Fixo, sem detalhe de costura.

Encosto: Fixo, com costura em em pesponto simples.

Braço: Fixo, com costura em em pesponto simples.

Almofada de Braço: Removível, sem detalhe de costura, com 30x70cm Almofada de.

Encosto: Solta, com opção de aberta ou fechada, sem detalhe de costura, com altura de 55cm Almofada.

Lombar: Solta, com opção de aberta ou fechada, sem detalhe de costura, com altura de 40cm.

Suporte: Pés niveladores em aço carbono.

Obs.: Para módulos com braço, na opção fechada, as almofadas de encosto e lombar irão até a almofada de braço. Quando aberta, elas terão 10cm a menos que o comprimento total até a almofada de braço. As demais modulações seguem a regra padrão.

Obs. 2: O modelo conta com caixa de assento compartilhada entre módulos, por isso as modulação seguem padrão bipartido.

Obs. 3: O modelo não conta com nenhum tipo de conector entre os módulos

Medidas podem apresentar leves variações. Nos reservamos o direito de efetuar alterações sem consulta prévia.

Seat: Fixed, without stitching details.

Backrest: Fixed, with single topstitching.

Armrest: Fixed, with single topstitching.

Arm Cushion: Removable, without stitching details, measuring 30 x 70 cm.

Back Cushion: Loose, available in open or closed option, without stitching details, 55 cm height.

Lumbar Cushion: Loose, available in open or closed option, without stitching details, 40 cm height.

Support: Carbon steel leveling feet.

Note: For modules with armrests, in the closed option, the back and lumbar cushions extend up to the arm cushion. In the open option, they will be 10 cm shorter than the total length up to the arm cushion. The remaining modules follow the standard rule.

Note 2: The model features a shared seat box between modules; therefore, the configurations follow a split-module standard.

Note 3: The model does not include any type of connector between modules.

Measures may vary slightly. We reserve the right to make changes without prior consultation.

*For more information, see our Comfort Guide.

Asiento: Fijo, sin detalle de costura.

Respaldo: Fijo, con costura en pespunte simple.

Braço: Fijo, con costura en pespunte simple.

Cojín de Braço: Removable, sin detalle de costura, con medidas de 30 x 70 cm.

Cojín de Respaldo: Suelto, con opción abierta o cerrada, sin detalle de costura, con altura de 55 cm.

Cojín Lumbar: Suelto, con opción abierta o cerrada, sin detalle de costura, con altura de 40 cm.

Suporte: Patas niveladoras en acero al carbono.

Obs.: Para módulos con brazo, en la opción cerrada, los cojines de respaldo y lumbar llegan hasta el cojín de brazo. En la opción abierta, tendrán 10 cm menos que la longitud total hasta el cojín de brazo. Las demás modulaciones siguen la regla estándar.

Obs. 2: El modelo cuenta con caja de asiento compartida entre módulos; por lo tanto, las modulaciones siguen un estándar bipartido.

Obs. 3: El modelo no incluye ningún tipo de conector entre los módulos.

Las medidas pueden variar un poco. Nos reservamos el derecho de realizar cambios sin previa consulta.

*Para más informaciones, consulte nuestro Guía de Confort.

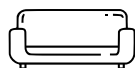

ponto**vírgula**
+
Persch Objects

Uccelli



SOFÁS
SOFÁS | SOFÁS

ponto**vírgula**



Uccelli

SOFÁS
SOFAS | SOFÁS

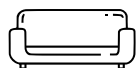

Uccelli

SOFÁS
SOFAS | SOFÁS

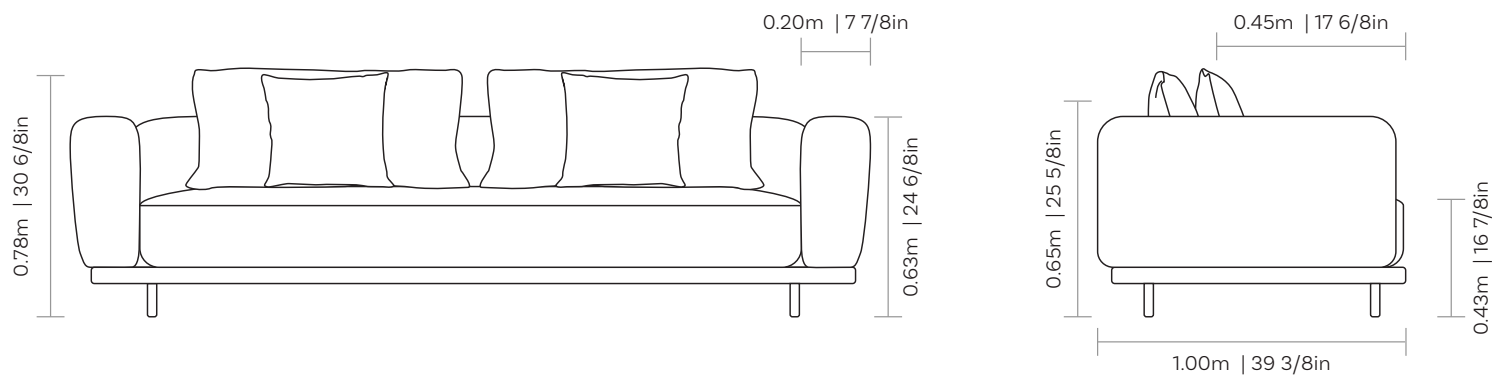

Assento, encosto e braços fixos com costura em pesponto simples. Almofada de encosto solta sem detalhes de costura. Almofada decorativa de 50x50cm, sem detalhe de costura. Pés em madeira, disponível nos acabamentos verniz e pinturas laca e laca metalizada. Aparador tapeçado com tampo disponível nos acabamentos laminado e pinturas laca e laca metalizada. Estrutura do aparador em aço carbono, disponível nos acabamentos MTX e metalizado.

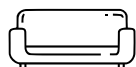

Uccelli

SOFÁS
SOFAS | SOFÁS

2 BRAÇOS 1 ASSENTO

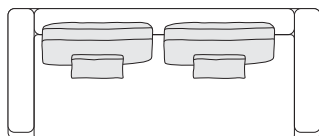

DIMENSÕES	ENCOSTO	ALMOFADA
DIMENSIONS DIMENSIONES	BACKREST RESPALDO	CUSHION COJINES
2.00m x 1.00m	2	2
2.20m x 1.00m	2	2
2.40m x 1.00m	2	2
2.60m x 1.00m	2	2
2.80m x 1.00m	2	2
3.00m x 1.00m	2	2

1 BRAÇOS 1 ASSENTO

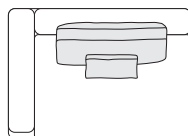

DIMENSÕES	ENCOSTO	ALMOFADA
DIMENSIONS DIMENSIONES	BACKREST RESPALDO	CUSHION COJINES
1.00m x 1.00m	1	1
1.10m x 1.00m	1	1
1.20m x 1.00m	1	1
1.30m x 1.00m	1	1
1.40m x 1.00m	1	1
1.50m x 1.00m	1	1
1.80m x 1.00m	2	2
2.00m x 1.00m	2	2
2.20m x 1.00m	2	2
2.40m x 1.00m	2	2
2.60m x 1.00m	2	2
2.80m x 1.00m	2	2

SEM BRAÇO 1 ASSENTO

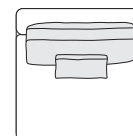

DIMENSÕES	ENCOSTO	ALMOFADA
DIMENSIONS DIMENSIONES	BACKREST RESPALDO	CUSHION COJINES
0.80m x 1.00m	1	1
0.90m x 1.00m	1	1
1.00m x 1.00m	1	1
1.10m x 1.00m	1	1
1.20m x 1.00m	1	1
1.30m x 1.00m	1	1
1.60m x 1.00m	2	2
1.80m x 1.00m	2	2
2.00m x 1.00m	2	2
2.20m x 1.00m	2	2
2.40m x 1.00m	2	2
2.60m x 1.00m	2	2

SEM BRAÇO BICO

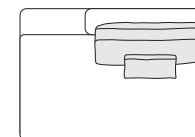

DIMENSÕES	ENCOSTO	ALMOFADA
DIMENSIONS DIMENSIONES	BACKREST RESPALDO	CUSHION COJINES
1.30m x 1.00m	1	1
1.40m x 1.00m	1	1
1.50m x 1.00m	1	1
1.60m x 1.00m	1	1
1.70m x 1.00m	1	1
1.80m x 1.00m	1	1

SEM BRAÇO BICO APARADOR

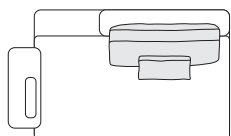

DIMENSÕES	ENCOSTO	ALMOFADA
DIMENSIONS DIMENSIONES	BACKREST RESPALDO	CUSHION COJINES
1.50m x 1.00m	1	1
1.60m x 1.00m	1	1
1.70m x 1.00m	1	1
1.80m x 1.00m	1	1
1.90m x 1.00m	1	1
2.00m x 1.00m	1	1

CANTO

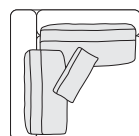

DIMENSÕES	ENCOSTO	ALMOFADA
DIMENSIONS DIMENSIONES	BACKREST RESPALDO	CUSHION COJINES
1.00m x 1.00m	2	1

SEM BRAÇO CURVO

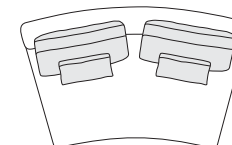

DIMENSÕES	COMP. FRENTE		ENCOSTO	ALMOFADA
DIMENSIONS DIMENSIONES	FRONT LENGHT	LONGT. DELANTERA	BACKREST RESPALDO	CUSHION COJINES
1.45m x 1.03m		1.00m	2	2
1.55m x 1.04m		1.10m	2	2
1.65m x 1.05m		1.20m	2	2
1.75m x 1.06m		1.30m	2	2
2.05m x 1.09m		1.60m	2	2
2.25m x 1.11m		1.80m	2	2
2.45m x 1.13m		2.00m	2	2

Uccelli

SOFÁS
SOFAS | SOFÁS

1 BRAÇO CURVO

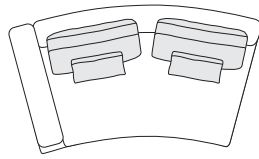

DIMENSÕES DIMENSIONS DIMENSIONES	COMP. FRENTE		ENCOSTO		ALMOFADA
	FRONT LENGTH	LONGT. DELANTERA	BACKREST	RESPALDO	CUSHION COJINES
1,65m x 1,05m	1,20m		2		2
1,75m x 1,06m	1,30m		2		2
1,85m x 1,07m	1,40m		2		2
1,95m x 1,10m	1,50m		2		2
2,25m x 1,12m	1,80m		2		2
2,45m x 1,14m	2,00m		2		2
2,65m x 1,16m	2,20m		2		2

SEM BRAÇO BICO CURVO

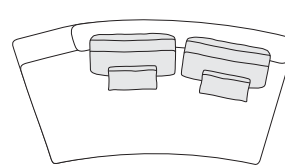

DIMENSÕES DIMENSIONS DIMENSIONES	COMP. FRENTE		ENCOSTO		ALMOFADA
	FRONT LENGTH	LONGT. DELANTERA	BACKREST	RESPALDO	CUSHION COJINES
1,95m x 1,08m	1,50m		2		2
2,05m x 1,09m	1,60m		2		2
2,15m x 1,10m	1,70m		2		2
2,25m x 1,11m	1,80m		2		2
2,35m x 1,12m	1,90m		2		2
2,45m x 1,13m	2,00m		2		2

SEM BRAÇO BICO CURVO APARADOR

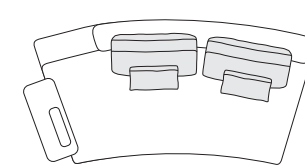

DIMENSÕES DIMENSIONS DIMENSIONES	COMP. FRENTE		ENCOSTO		ALMOFADA
	FRONT LENGTH	LONGT. DELANTERA	BACKREST	RESPALDO	CUSHION COJINES
2,15m x 1,08m	1,70m		1		2
2,25m x 1,09m	1,80m		1		2
2,35m x 1,10m	1,90m		1		2
2,45m x 1,11m	2,00m		1		2
2,55m x 1,12m	2,10m		1		2
2,65m x 1,13m	2,20m		1		2

Umfeld



SOFÁS
SOFAS | SOFÁS

ponto**vírgula**
+
Persch Objects



Umfeld

SOFÁS
SOFÁS | SOFÁS

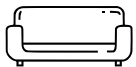

ponto**virgula**
+
Persch Objects

Umfeld

SOFÁS
SOFÁS | SOFÁS

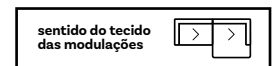
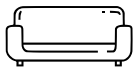
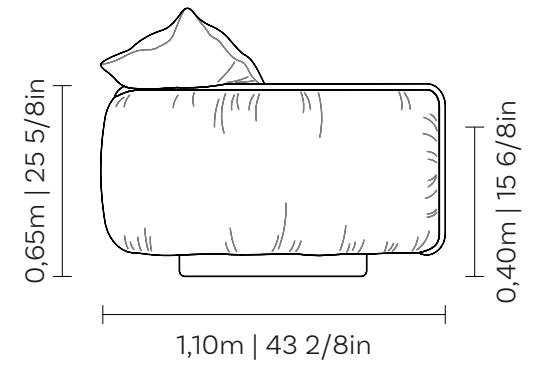
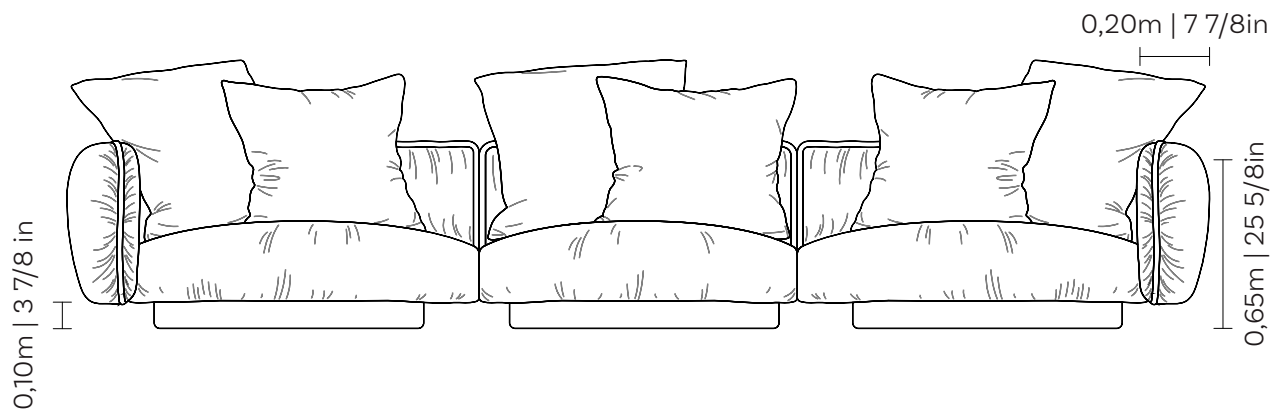

ponto**vírgula**
+ Persch Objects

Umfeld

SOFÁS
SOFÁS | SOFÁS

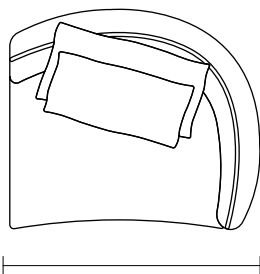

1B 1AS (D/E)	ASS	DEC MAIOR	DEC MENOR
1,25 x 1,10 m 49 2/8 x 43 2/8 in	1	1	1
1,35 x 1,10 m 53 1/8 x 43 2/8 in	1	1	1
1,45 x 1,10 m 57 1/8 x 43 2/8 in	1	1	1

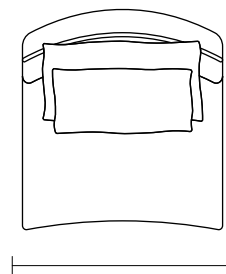

SB 1AS	ASS	DEC MAIOR	DEC MENOR
1,00 x 1,10 m 39 3/8 x 43 2/8 in	1	1	1
1,10 x 1,10 m 43 2/8 x 43 2/8 in	1	1	1
1,20 x 1,10 m 47 2/8 x 43 2/8 in	1	1	1

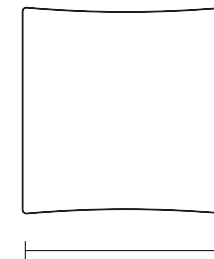

PUFF MEIO	ASS
1,00 x 0,95 m 39 3/8 x 37 3/8 in	1
1,10 x 0,95 m 43 2/8 x 37 3/8 in	1
1,20 x 0,95 m 47 2/8 x 37 3/8 in	1

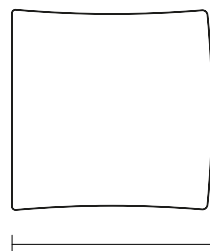

PUFF BI (D/E)	ASS
1,00 x 0,95 m 39 3/8 x 37 3/8 in	1
1,10 x 0,95 m 43 2/8 x 37 3/8 in	1
1,20 x 0,95 m 47 2/8 x 37 3/8 in	1

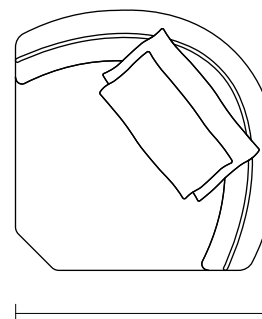

CTO CH	ASS	DEC MAIOR	DEC MENOR
1,30 x 1,30 m 51 1/8 x 51 1/8 in	1	1	1

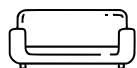
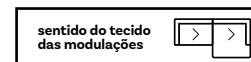

ponto**vírgula**
+ Persch Objects

Umfeld

SOFÁS
SOFÁS | SOFÁS

Assento: fixo, sem detalhe de costura e com sobra de tecido.
Encosto: fixo, com debrum e detalhes de tecido dobrado.
Braço: fixo, com debrum e detalhes de tecido dobrado.
Suporte: base em metal, disponível nos acabamentos pintura metalizada, pintura fosca, laminado e laminado.

Medidas podem apresentar leves variações. Nos reservamos o direito de efetuar alterações sem consulta prévia.

Seat: fixed, without stitching detail and with excess fabric
Backrest: fixed, with piping and folded fabric details
Armrest: fixed, with piping and folded fabric details
Support: metal base, available in metallic paint, matte paint, laminate, and special laminate finishes.

Measures may vary slightly. We reserve the right to make changes without prior consultation.
*For more information, see our Comfort Guide.

Asiento: fijo, sin detalle de costura y con excedente de tela
Respaldo: fijo, con ribete y detalles de tela doblada
Brazo: fijo, con ribete y detalles de tela doblada
Soporte: base metálica, disponible en acabados de pintura metalizada, pintura mate, laminado y laminado.

Las medidas pueden variar un poco. Nos reservamos el derecho de realizar cambios sin previa consulta.
*Para más informaciones, consulte nuestro Guía de Confort.

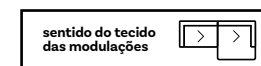
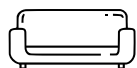

ponto**vírgula**
+
Persch Objects

POLTRONAS

ARMCHAIRS | SILLONES

ponto**vírgula**

Arlo



POLTRONAS
ARMCHAIR | SILLONES

pontovírgula



Arlo

POLTRONAS
ARMCHAIR | SILLONES



Arlo

POLTRONAS
ARMCHAIR | SILLONES

Poltrona armchair | sillone

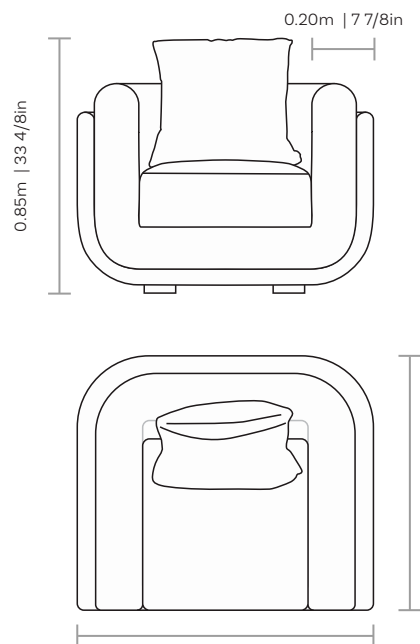

DIMENSÕES
DIMENSIONS | DIMENSIONES

1.00m x 0.85m | 39 3/8in x 33 4/8in

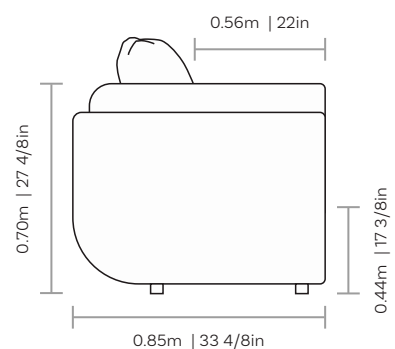

Puff ottoman | puff

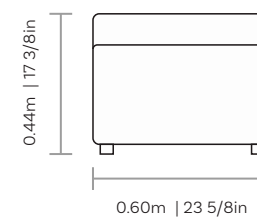
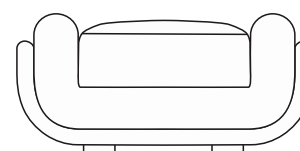

DIMENSÕES
DIMENSIONS | DIMENSIONES

1.00m x 0.60m | 39 3/8in x 23 5/8in

Assento, encosto e braços fixos, com costura em pesponto duplo. Almofada de assento com costura em pesponto duplo, espumas em eco-espuma, D26 e D20 soft, envoltas em manta siliconada. Opção de suporte fixo, com pés em polipropileno, ou base giratória, em aço carbono na cor MTX preto.



Axis



POLTRONAS
ARMCHAIR | SILLONES

ponto**vírgula**



Axis

POLTRONAS
ARMCHAIR | SILLONES



Axis

POLTRONAS
ARMCHAIR | SILLONES

base fixa

fixed base | base fija

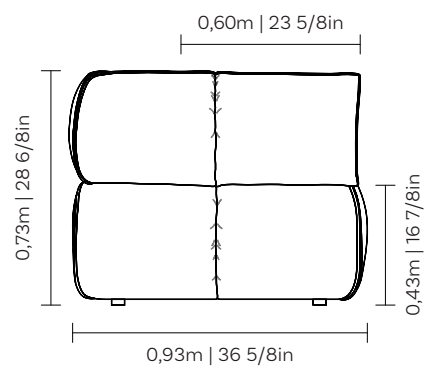
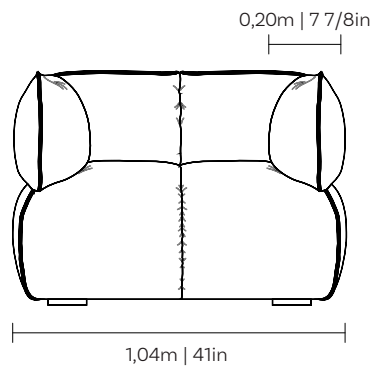

base giratória

swivel base | base giratoria

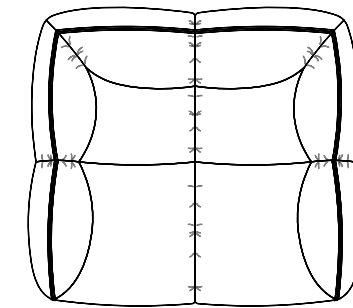
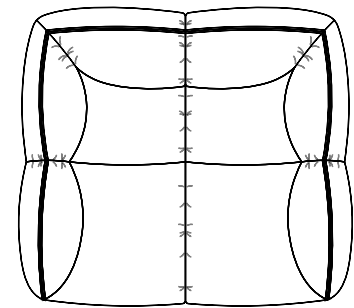
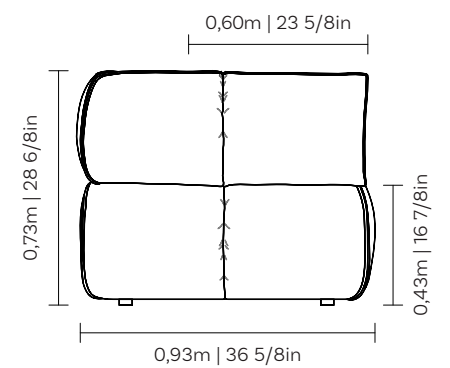
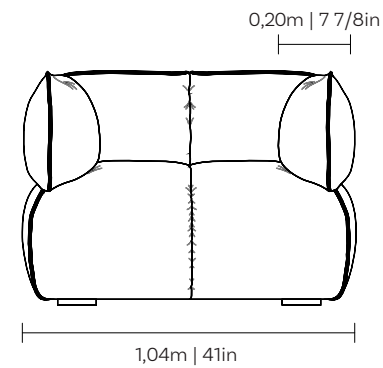

Axis

POLTRONAS
ARMCHAIR | SILLONES

Encosto: Fixo, com costura em fole.

Braço: Fixo, com costura em fole.

Assento: fixo, com costura em fole e detalhe puxado.

Suporte: Opção de suporte fixo, com pés em polipropileno injetado na cor preta, ou base giratória, em aço carbono na cor MTX preto.

Medidas podem apresentar leves variações. Nos reservamos o direito de efetuar alterações sem consulta prévia.

Backrest: Fixed, with pleated stitching.

Armrest: Fixed, with pleated stitching.

Seat: fixed, with gusseted stitching and gathered detail.

Support: Option of fixed support, with injected polypropylene feet in black, or swivel base in carbon steel with MTX black finish.

Measures may vary slightly. We reserve the right to make changes without prior consultation.

*For more information, see our Comfort Guide.

Respaldo: Fijo, con costura en pliegue.

Brazos: Fijos, con costura en pliegue.

Asiento: fijo, con costura en fuelle y detalle fruncido.

Soporte: Opción de soporte fijo, con patas de polipropileno inyectado en color negro, o base giratoria de acero al carbono en color negro MTX.

Las medidas pueden variar un poco. Nos reservamos el derecho de realizar cambios sin previa consulta.

*Para más informaciones, consulte nuestro Guía de Comfort.



ponto**vírgula**

Bauen



POLTRONAS
ARMCHAIR | SILLONES

pontovírgula



Bauen

POLTRONAS
ARMCHAIR | SILLONES



Bauen

POLTRONAS
ARMCHAIR | SILLONES

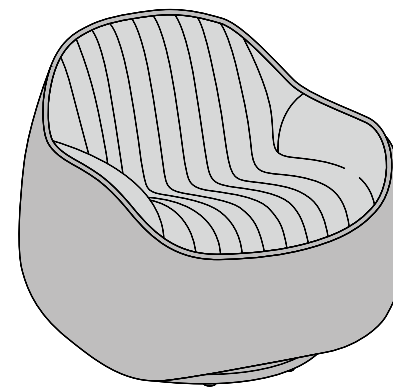
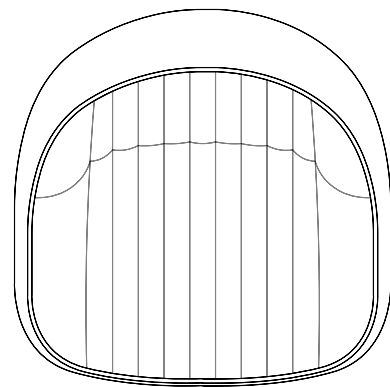
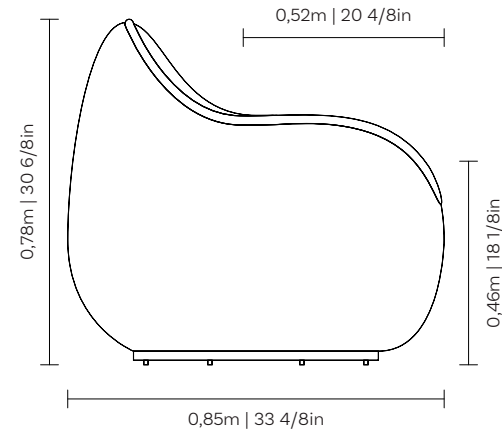
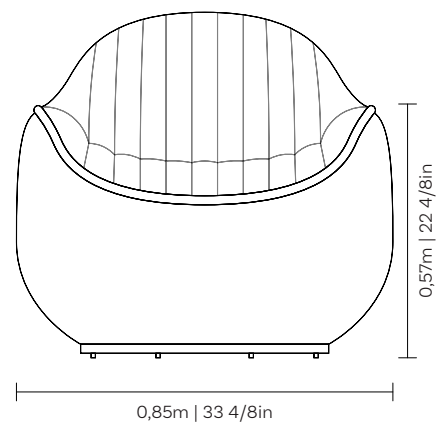

Bauen

POLTRONAS
ARMCHAIR | SILLONES

Assento: Fixo, com costura em debrum.
Encosto: Fixo, com costura em debrum e pesponto duplo e zíper.
Braço: Fixo, com costura em debrum.
Suporte: Opção de suporte fixo, com pés em polipropileno injetado na cor preta, ou base giratória, em aço carbono na cor MTX preto, revestida com tecido.

Medidas podem apresentar leves variações. Nos reservamos o direito de efetuar alterações sem consulta prévia.

Seat: Fixed, with piping trim stitching.
Backrest: Fixed, with piping trim stitching, double topstitching, and zipper.
Arm: Fixed, with piping trim stitching.
Support: Option of a fixed support with injected polypropylene feet in black, or a swivel base in carbon steel in MTX black, upholstered in fabric.

Measures may vary slightly. We reserve the right to make changes without prior consultation.
*For more information, see our Comfort Guide.

Asiento: Fijo, con costura en vivo (ribete).
Respaldo: Fijo, con costura en vivo (ribete), pespunte doble y cremallera.
Brazo: Fijo, con costura en vivo (ribete).
Soporte: Opción de soporte fijo con patas de polipropileno inyectado en color negro, o base giratoria en acero al carbono en color MTX negro, revestida en tela.

Las medidas pueden variar un poco. Nos reservamos el derecho de realizar cambios sin previa consulta.
*Para más informaciones, consulte nuestro Guía de Confort.



Belle



POLTRONAS
ARMCHAIR | SILLONES

pontovírgula



Belle

POLTRONAS
ARMCHAIR | SILLONES



Belle

POLTRONAS
ARMCHAIR | SILLONES

base giratória

swivel base | base giratoria

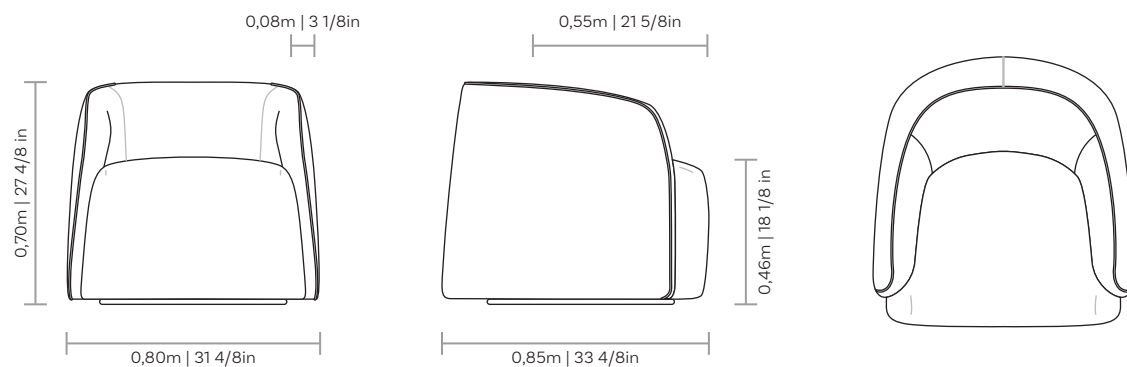

base fixa

fixed base | base fija

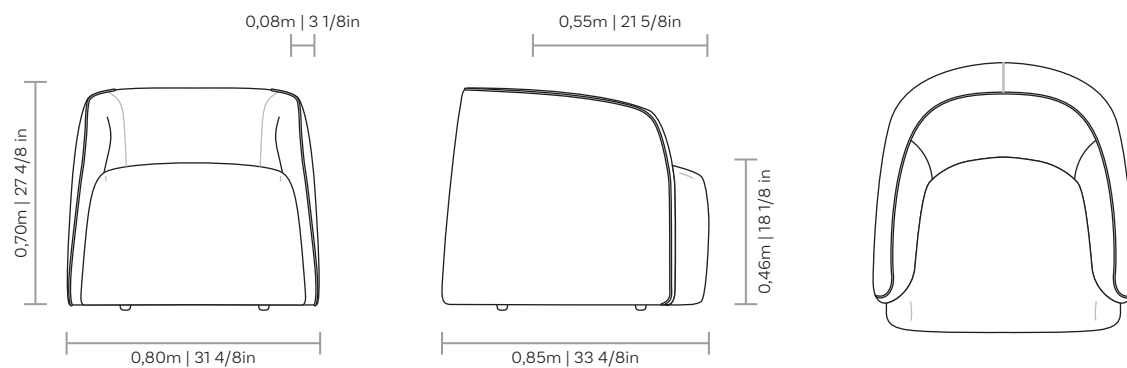

● DEBRUM COMPOSÊ

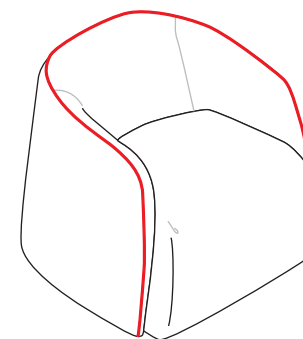

Belle

POLTRONAS
ARMCHAIR | SILLONES

Assento: Fixo, sem detalhe de costura.

Encosto: Fixo, com costura em debrum composê, com opção em linho ou veludo.

Braço: Fixo, com costura em debrum composê, com opção em linho ou veludo.

Suporte: Opção de base giratória, em aço carbono no acabamento MTX na cor preta ou pé em polipropileno injetado na cor preta.

Medidas podem apresentar leves variações. Nos reservamos o direito de efetuar alterações sem consulta prévia.

Seat: Fixed, without seam detail.

Backrest: Fixed, with composite piping stitching, with linen or velvet option.

Armrest: Fixed, with composite piping stitching, with a linen or velvet option.

Support: Option of swivel base, in carbon steel in MTX finish in black color or foot in injected polypropylene in black color.

Measures may vary slightly. We reserve the right to make changes without prior consultation.

*For more information, see our Comfort Guide.

Asiento: Fijo, sin detalle de costuras.

Respaldo: Fijo, con costuras de ribete compuesto, con opción de lino o terciopelo.

Reposabrazos: Fijo, con costuras de ribete compuesto, con opción de lino o terciopelo.

Soporte: Opción de base giratoria, en acero al carbono en acabado MTX en color negro o pie en polipropileno inyectado en color negro.

Las medidas pueden variar un poco. Nos reservamos el derecho de realizar cambios sin previa consulta.

*Para más informaciones, consulte nuestro Guía de Confort.



Dezza



POLTRONAS
ARMCHAIR | SILLONES

pontovírgula



Dezza

POLTRONAS
ARMCHAIR | SILLONES



Dezza

POLTRONAS
ARMCHAIR | SILLONES

base giratória

swivel base | base giratoria

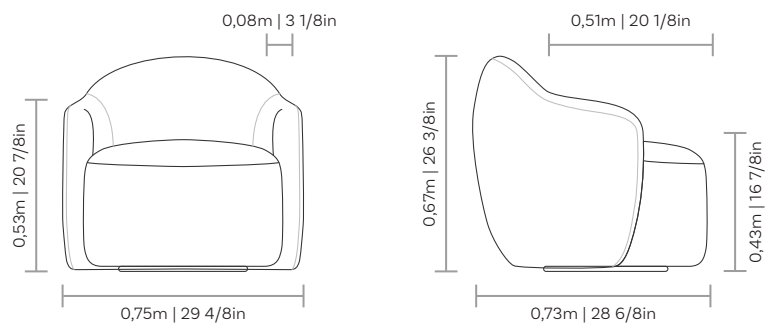

base fixa

fixed base | base fija

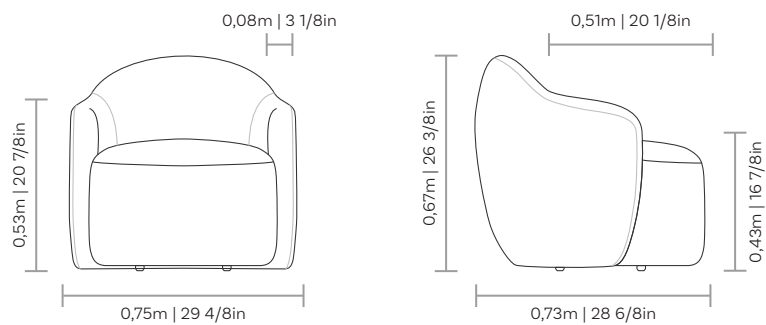

Dezza

POLTRONAS
ARMCHAIR | SILLONES

Assento: Fixo, com costura em pesponto simples.
Encosto: Fixo, com costura em pesponto simples e pesponto duplo.
Braço: Fixo, com costura em pesponto simples.
Suporte: Opção de base giratória, em aço carbono no acabamento MTX na cor preta ou pé em polipropileno injetado na cor preta.

Medidas podem apresentar leves variações. Nos reservamos o direito de efetuar alterações sem consulta prévia.

Seat: fixed, with simple stitching.
Backrest: fixed, with simple stitching and double stitching.
Armrests: fixed, with simple stitching.
Support: swivel base in carbon steel in MTX finish in black color or foot in injected polypropylene in black color.

Measures may vary slightly. We reserve the right to make changes without prior consultation.
*For more information, see our Comfort Guide.

Asiento: fijo, con costuras simples.
Respaldo: fijo, con costuras simples e doble pespunte.
Brazos: fijo, con costuras simples.
Soporte: base giratoria en acero al carbono en acabado MTX en color negro o pata en polipropileno inyectado en color negro.

Las medidas pueden variar un poco. Nos reservamos el derecho de realizar cambios sin previa consulta.
*Para más informaciones, consulte nuestro Guía de Confort.



Domia



POLTRONAS
ARMCHAIR | SILLONES

ponto**vírgula**



Domia

POLTRONAS
ARMCHAIR | SILLONES



Domia

POLTRONAS
ARMCHAIR | SILLONES

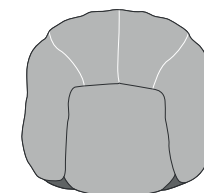
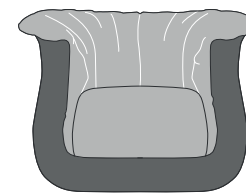
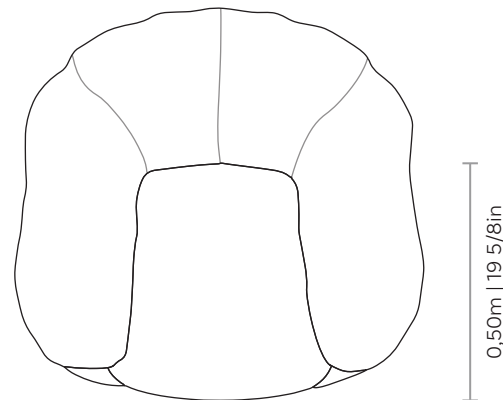
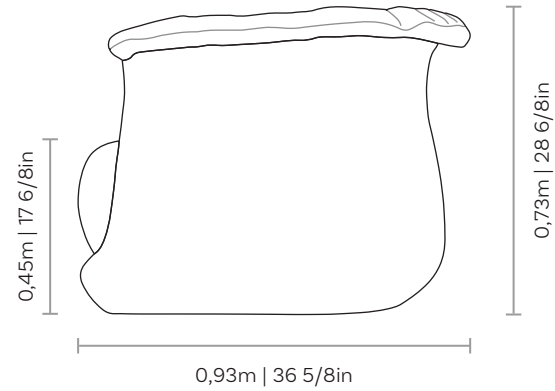
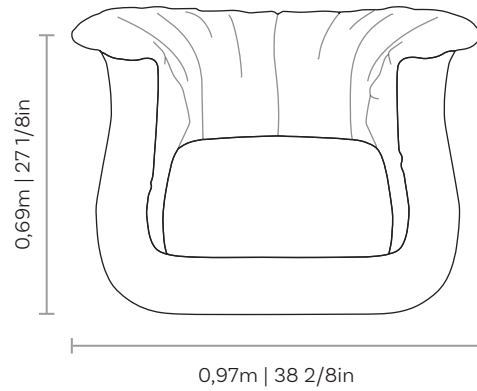

caixa
corpo



Domia

POLTRONAS
ARMCHAIR | SILLONES

Assento e encosto fixos com costura em pesponto duplo. Almofada de assento, encosto e braços sem detalhe de costura, com sobra de tecido. Opção de pé em polipropileno injetado preto ou base giratória na cor MTX preto.

Medidas podem apresentar leves variações. Nos reservamos o direito de efetuar alterações sem consulta prévia.

Fixed seat and backrest with doble backstitch. Seat, backrest and armrests cushion without seam detail, with excess of fabric. Black injected polypropylene feet or swivel base in black microtextured electrostatic painting.

Measures may vary slightly. We reserve the right to make changes without prior consultation.

*For more information, see our Comfort Guide.

Asiento y respaldo fijos con doble pespunte. Cojín de asiento, respaldo y brazos sin detalle de costura, con arugas de tejido. Patas en polipropileno inyectado color negro o base giratoria con pintura electroestática microtexturada color negro.

Las medidas pueden variar un poco. Nos reservamos el derecho de realizar cambios sin previa consulta.

*Para más informaciones, consulte nuestro Guía de Confort.



Harper



POLTRONAS
ARMCHAIR | SILLONES

ponto**vírgula**



Harper

POLTRONAS
ARMCHAIR | SILLONES



Harper



POLTRONAS
ARMCHAIR | SILLONES

Base giratória

swivel base | base giratoria

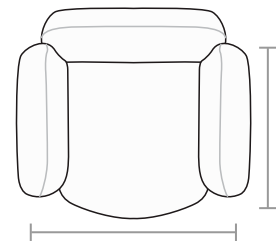
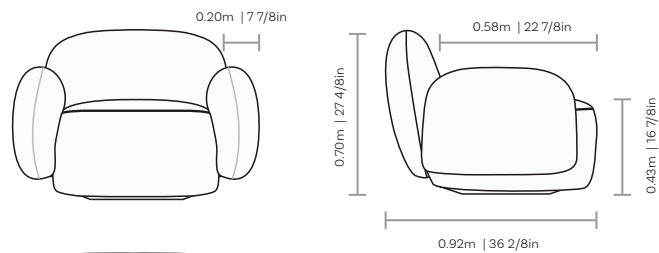

DIMENSÕES
DIMENSIONS | DIMENSIONES

1.02m x 0.92m | 40 1/8in x 36 2/8in

Pés injetados

injected feet | patas inyectados

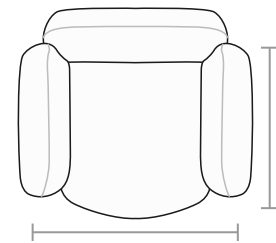
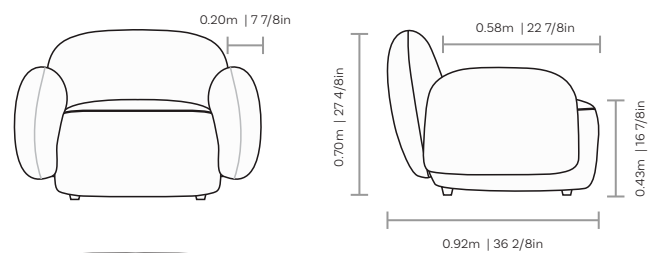

DIMENSÕES
DIMENSIONS | DIMENSIONES

1.02m x 0.92m | 40 1/8in x 36 2/8in

Puff

ottoman | puff

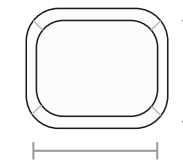
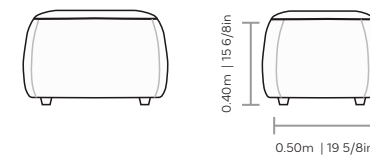

DIMENSÕES
DIMENSIONS | DIMENSIONES

0.62m x 0.50m | 24 3/8in x 19 5/8in

Assento, encosto e braços fixos, com costura em pesponto duplo. Almofada de assento com costura em pesponto duplo, espumas em eco-espuma, D26 e D20 soft, envoltas em manta siliconada. Opção de suporte fixo, com pés em polipropileno, ou base giratória, em aço carbono na cor MTX preto.



Harry



POLTRONAS
ARMCHAIRS | SILLONES

ponto**vírgula**



Harry

POLTRONAS
ARMCHAIRS | SILLONES



Harry

Tecido
3D

POLTRONAS
ARMCHAIRS | SILLONES

Poltrona
armchair | sillone

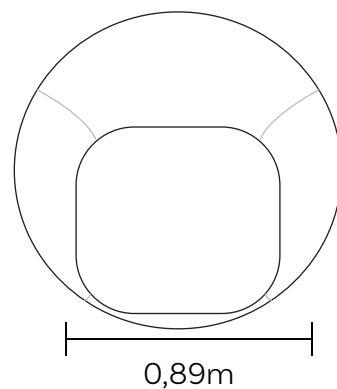
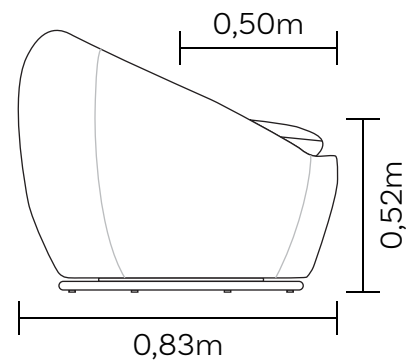
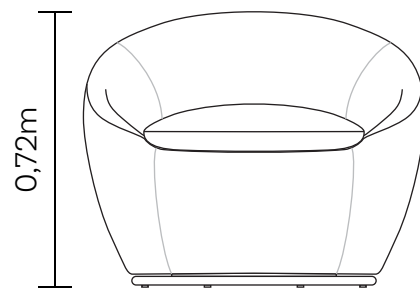

Assento, almofada de assento, encosto e braço fixos com costura em pesponto duplo. Pés em polipropileno injetado ou base giratória em aço carbono no acabamento MTX preto.



pontovírgula

Iris



POLTRONAS
ARMCHAIR | SILLONES

ponto**vírgula**



Iris

POLTRONAS
ARMCHAIR | SILLONES



Iris

POLTRONAS
ARMCHAIR | SILLONES

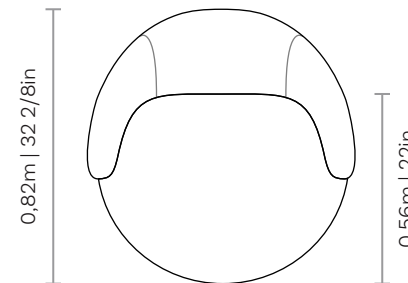
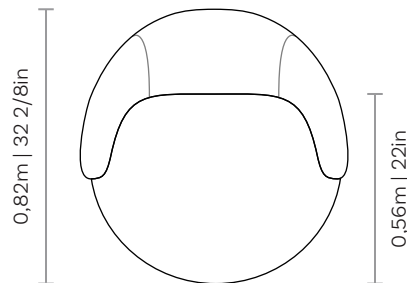
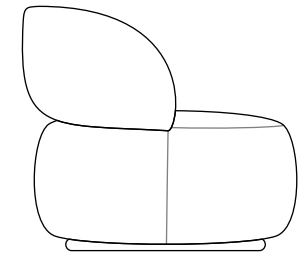
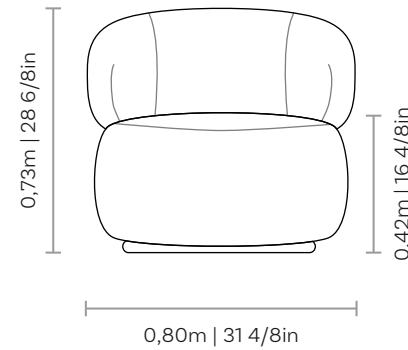
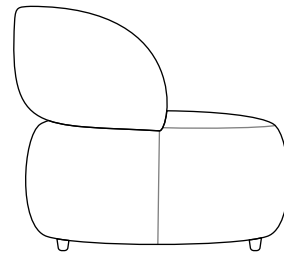
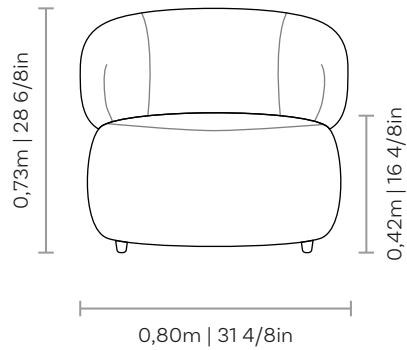

Iris

POLTRONAS
ARMCHAIR | SILLONES

Assento e encosto fixos com costura em pesponto simples.
Almofada de assento fixa com costura em simples. Opção
de base giratória ou pé em polipropileno injetado.

Medidas podem apresentar leves variações. Nos reservamos o direito de efetuar alterações sem consulta prévia.

Fixed seat and backrest with simple backstitch.
Fixed seat cushion with simple
backstitch. Polypropylene feet or swivel base.

Measures may vary slightly. We reserve the right to make changes without prior consultation.

Asiento y respaldo fijos con costura simples.
Cojín de asiento fijo con costura simple. Patas
en polipropileno inyectado o base giratoria.

Las medidas pueden variar un poco. Nos reservamos el derecho de realizar cambios sin previa consulta.



Ivy



POLTRONAS
ARMCHAIR | SILLONES

pontovírgula



Ivy

POLTRONAS
ARMCHAIR | SILLONES



pontovírgula

Ivy

POLTRONAS ARMCHAIR | SILLONES

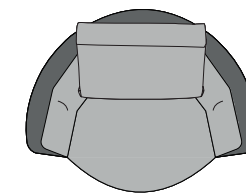
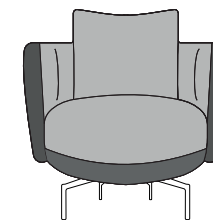
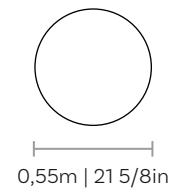
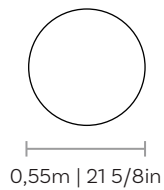
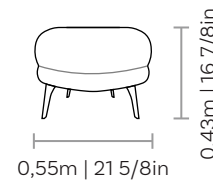
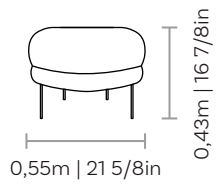
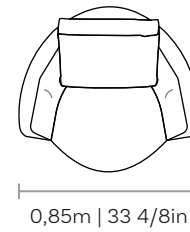
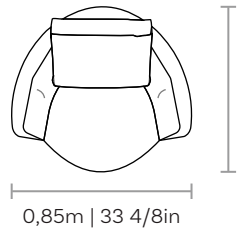
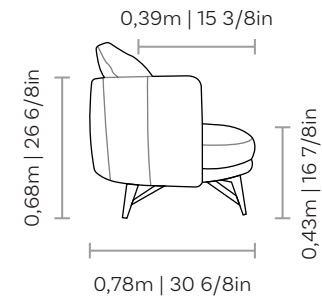
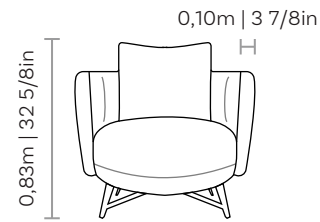
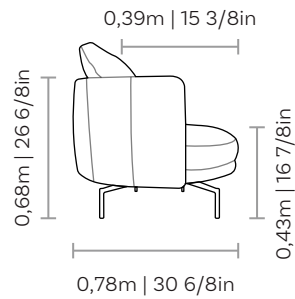
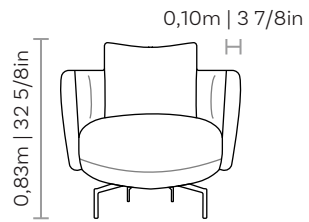

Ivy

POLTRONAS
ARMCHAIR | SILLONES

Assento fixo, com costura em pesponto simples. Encosto e braços fixos, com costura em pesponto duplo e debrum. Base e pés em madeira, disponíveis nos acabamentos: pintura laca, laca metalizada e pintura verniz. Base e pés em aço carbono, disponíveis em pintura MTX e pintura metalizada.

Medidas podem apresentar leves variações. Nos reservamos o direito de efetuar alterações sem consulta prévia.

Seat, backrest and fixed arms. Wooden base and feet, available in lacquer paint, metallic lacquer and varnish paint finishes. Base and feet in carbon steel, available in MTX paint and metallic paint.

Measures may vary slightly. We reserve the right to make changes without prior consultation.

*For more information, see our Comfort Guide.

Asiento, respaldo y brazos fijos. Base y pies de madera, disponibles en acabados: pintura lacada, laca metalizada y pintura barniz. Base y pies en acero al carbono, disponibles en pintura MTX y pintura metalizada.

Las medidas pueden variar un poco. Nos reservamos el derecho de realizar cambios sin previa consulta.

*Para más informaciones, consulte nuestro Guía de Confort.



ponto**vírgula**

Jenny



POLTRONAS
ARMCHAIR | SILLONES

pontovírgula



Jenny

POLTRONAS
ARMCHAIR | SILLONES



Jenny

POLTRONAS
ARMCHAIR | SILLONES

base giratória

swivel base | base giratoria

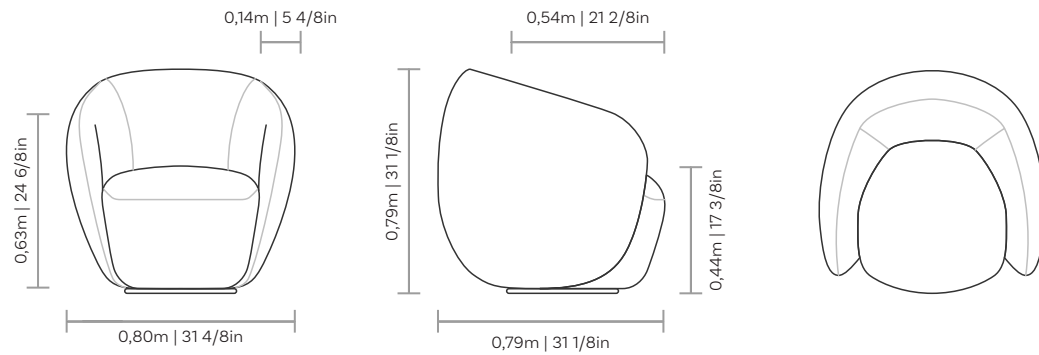

base fixa

fixed base | base fija

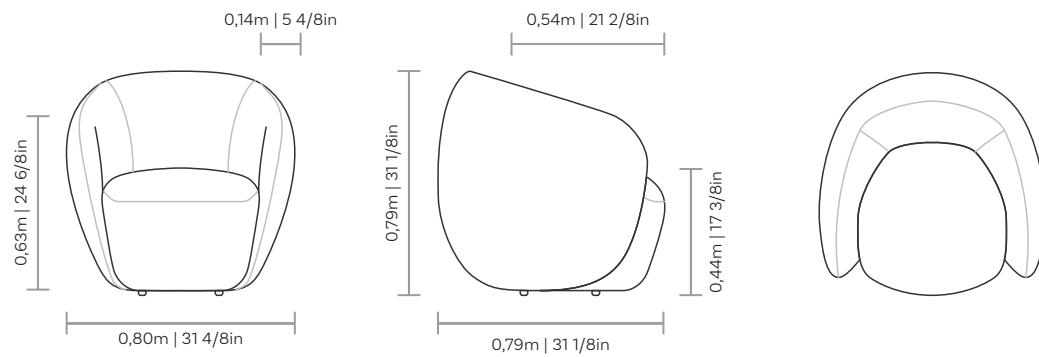

Jenny

POLTRONAS
ARMCHAIR | SILLONES

Assento: Fixo, com costura em pesponto simples
Encosto: Fixo, com costura em pesponto duplo
Braço: Fixo, com costura em pesponto duplo
Suporte: Opção de base giratória, em aço carbono no acabamento MTX na cor preta ou pé em polipropileno injetado na cor preta.

Medidas podem apresentar leves variações. Nos reservamos o direito de efetuar alterações sem consulta prévia.

Seat: fixed, with simple backstich.
Backrest: fixed, with double backstich.
Armrests: fixed, with double backstich.
Support: fixed, with black injected polypropylene feet, or swivel base in carbon steel in black microtextured electrostatic painting.

Measures may vary slightly. We reserve the right to make changes without prior consultation.

*For more information, see our Comfort Guide.

Asiento: fijo con costuras simples.
Respaldo: fijo con doble pespunte.
Brazos: fijo con doble pespunte.
Soporte: fijo, con pies en polipropileno inyectado en color negro, o base giratoria en acero al carbono en color negro MTX, recubierta de tela.

Las medidas pueden variar un poco. Nos reservamos el derecho de realizar cambios sin previa consulta.

*Para más informaciones, consulte nuestro Guía de Confort.



Klaris



POLTRONAS
ARMCHAIR | SILLONES

pontovírgula



Klaris

POLTRONAS
ARMCHAIR | SILLONES



Klaris

POLTRONAS
ARMCHAIR | SILLONES

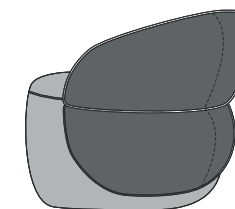
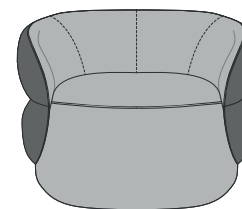
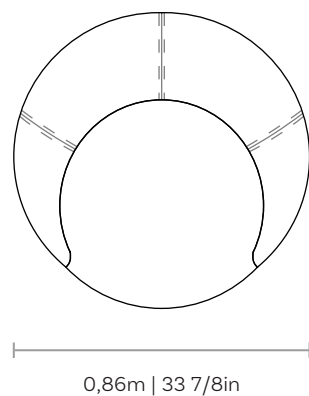
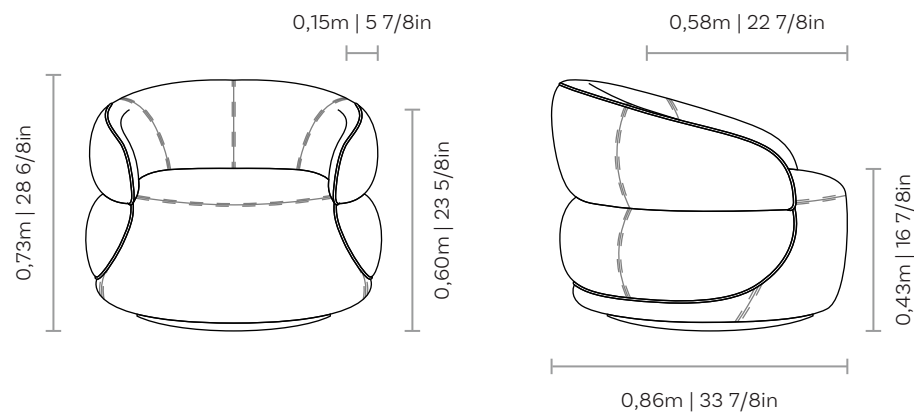

caixa
corpo



Klaris

POLTRONAS
ARMCHAIR | SILLONES

Assento, encosto e Braço com costura em pesponto duplo.
Base giratória em aço carbono disponível na cor preta ou
pés em polipropileno injetado na cor preta.

Medidas podem apresentar leves variações. Nos reservamos o direito de efetuar alterações sem consulta prévia.

Seat, backrest and armrest with double topstitching. Swivel
base in carbon steel available in black or feet in injected
polypropylene in black.

Measures may vary slightly. We reserve the right to make changes without prior consultation.

Asiento, respaldo y reposabrazos con doble pespunte.
Base giratoria en acero al carbono disponible en negro
o pies en polipropileno inyectado en negro.

Las medidas pueden variar un poco. Nos reservamos el derecho de realizar cambios sin previa consulta.



Liesel



POLTRONAS
ARMCHAIR | SILLONES

ponto**vírgula**



Liessel

POLTRONAS
ARMCHAIR | SILLONES



Liessel

POLTRONAS
ARMCHAIR | SILLONES

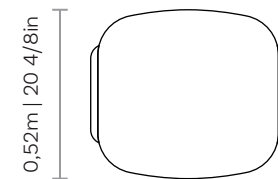
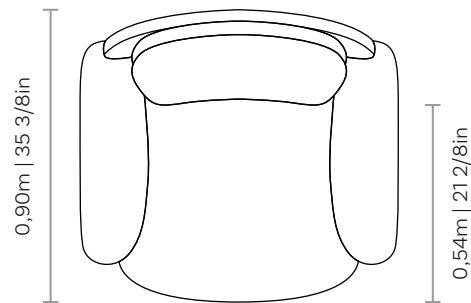
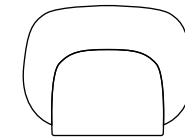
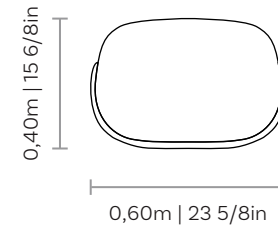
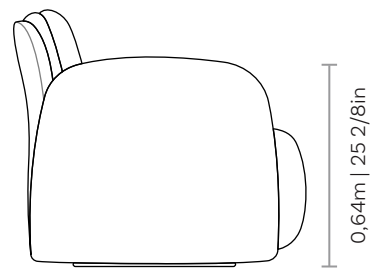
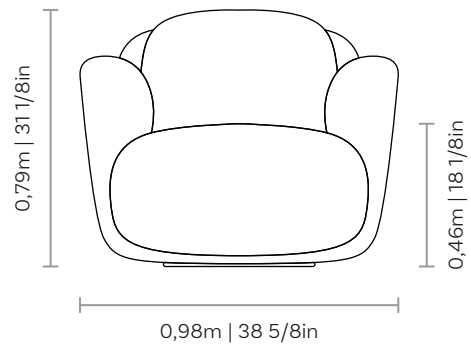

Liessel

POLTRONAS
ARMCHAIR | SILLONES

Assento, encosto, braços e almofada de assento fixos com costura em pesponto duplo. Pés em polipropileno injetado na cor preta ou base giratória na cor MTX preto.

Medidas podem apresentar leves variações. Nos reservamos o direito de efetuar alterações sem consulta prévia.

Fixed seat, backrest and armrests with double backstitch stitching. Black injected polypropylene feet or swivel base in black microtextured electrostatic painting.

Measures may vary slightly. We reserve the right to make changes without prior consultation.

Asiento, respaldo y brazos fijos con doble pespunte. Patas em polipropileno injectado color negro o base giratória com pintura electrostática microtexturada color negro.

Las medidas pueden variar un poco. Nos reservamos el derecho de realizar cambios sin previa consulta.



Lina



POLTRONAS
ARMCHAIR | SILLONES

ponto**vírgula**



Lina

POLTRONAS
ARMCHAIR | SILLONES



Lina

POLTRONAS
ARMCHAIR | SILLONES

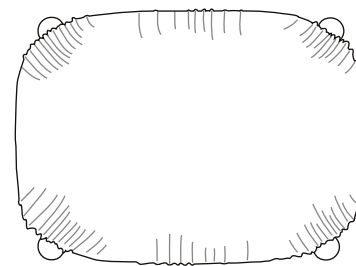
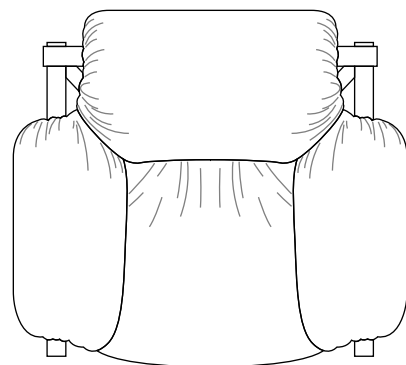
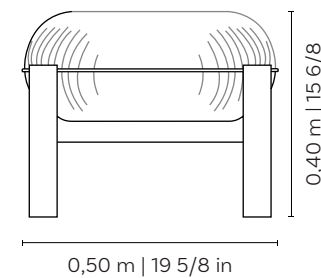
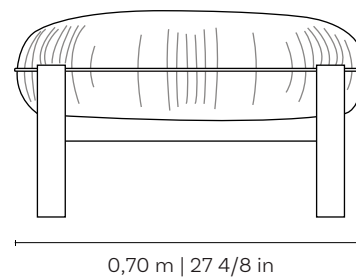
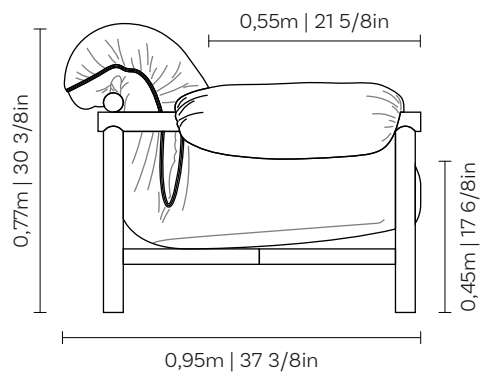
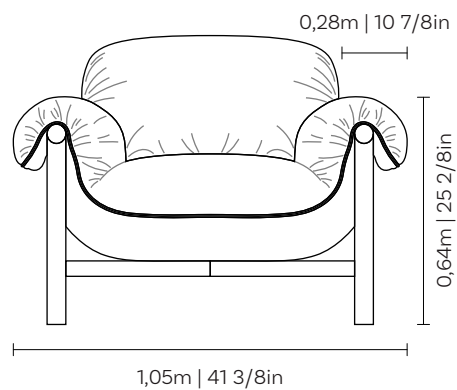

Lina

POLTRONAS
ARMCHAIR | SILLONES

Assento: Fixo, com costura em debrum e sobra de tecido
Encosto: Fixo, com costura em debrum e sobra de tecido
Braço: Fixo, com costura em debrum e sobra de tecido
Suporte: Base em madeira, disponível no acabamento verniz.

Medidas podem apresentar leves variações. Nos reservamos o direito de efetuar alterações sem consulta prévia.

Seat: Fixed, with piping stitching and fabric allowance.
Backrest: Fixed, with piping stitching and fabric allowance.
Armrest: Fixed, with piping stitching and fabric allowance.
Support: Wooden base, available in a varnish finish.

Measures may vary slightly. We reserve the right to make changes without prior consultation.
*For more information, see our Comfort Guide.

Asiento: Fijo, con costura con vivo y sobrante de tela.
Respaldo: Fijo, con costura con vivo y sobrante de tela.
Brazo: Fijo, con costura con vivo y sobrante de tela.
Soporte: Base de madera, disponible en acabado barnizado.

Las medidas pueden variar un poco. Nos reservamos el derecho de realizar cambios sin previa consulta.
*Para más informaciones, consulte nuestro Guía de Confort.



Miya



POLTRONAS
ARMCHAIR | SILLONES

pontovírgula



Miya

POLTRONAS
ARMCHAIR | SILLONES



Miya

POLTRONAS
ARMCHAIR | SILLONES

base giratória

swivel base | base giratoria

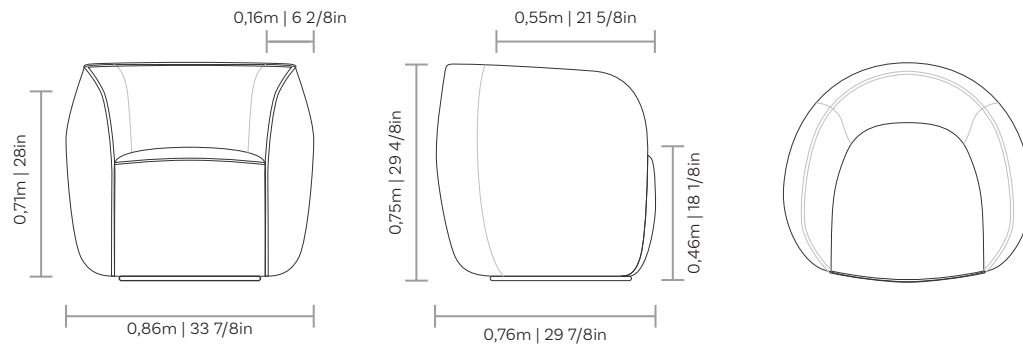

base fixa

fixed base | base fija

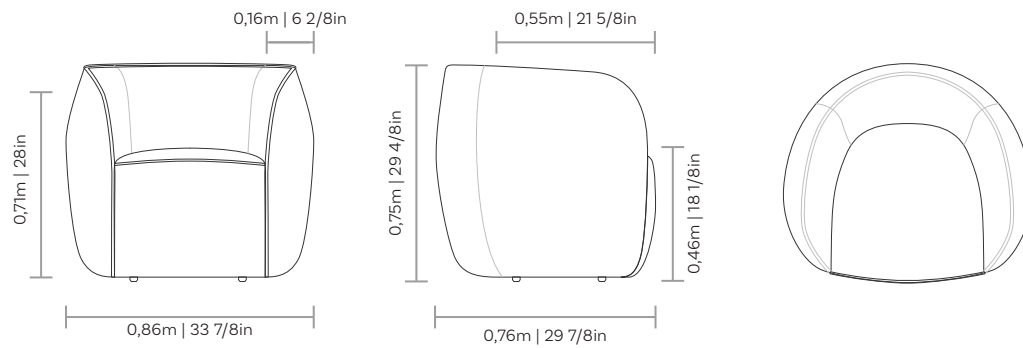

Miya

POLTRONAS
ARMCHAIR | SILLONES

Assento: Fixo, com costura em pesponto simples.
Encosto: Fixo, com costura em pesponto simples e debrum.
Braço: Fixo, com costura em debrum.
Suporte: Opção de base giratória, em aço carbono no acabamento MTX na cor preta ou pé em polipropileno injetado na cor preta.

Medidas podem apresentar leves variações. Nos reservamos o direito de efetuar alterações sem consulta prévia.

Seat: fixed, with simple backstich.
Backrest: fixed, with simple backstich and piping.
Armrests: fixed with piping stitching.
Support: fixed, with black injected polypropylene feet, or swivel base in carbon steel in black microtextured electrostatic painting.

Measures may vary slightly. We reserve the right to make changes without prior consultation.
*For more information, see our Comfort Guide.

Asiento: fijo con costuras simples.
Respaldo: fijo, con costura simples y ribetes sencillos.
Braço: fijo, con costuras ribeteadas.
Soporte: fijo, con pies en polipropileno inyectado en color negro, o base giratoria en acero al carbono en color negro MTX, recubierta de tela.

Las medidas pueden variar un poco. Nos reservamos el derecho de realizar cambios sin previa consulta.
*Para más informaciones, consulte nuestro Guía de Comfort.



NICKS

poltrona



ponto **vírgula**

NICKS

poltrona

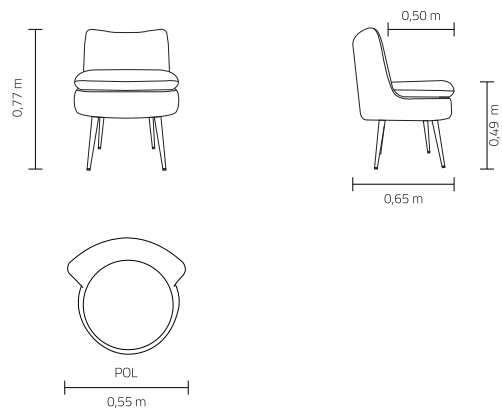

Assento, encosto e braço fixos com costura em pesponto simples. Poltrona e puff com pés em aço carbono disponíveis no acabamento pintura MTX.

Seat, backrest fixed. Fixed seat cushion. Carbon steel feet available in MTX paint finish.

Asiento, respaldo fijo. Cojín de asiento fijo. Pies de acero al carbono disponibles en acabado de pintura MTX.

•pV

Odisseia



POLTRONAS
ARMCHAIRS | SILLONES

ponto**vírgula**



Odisseia

POLTRONAS
ARMCHAIRS | SILLONES



Odisseia

POLTRONAS
ARMCHAIRS | SILLONES

Poltrona
armchair | sillone

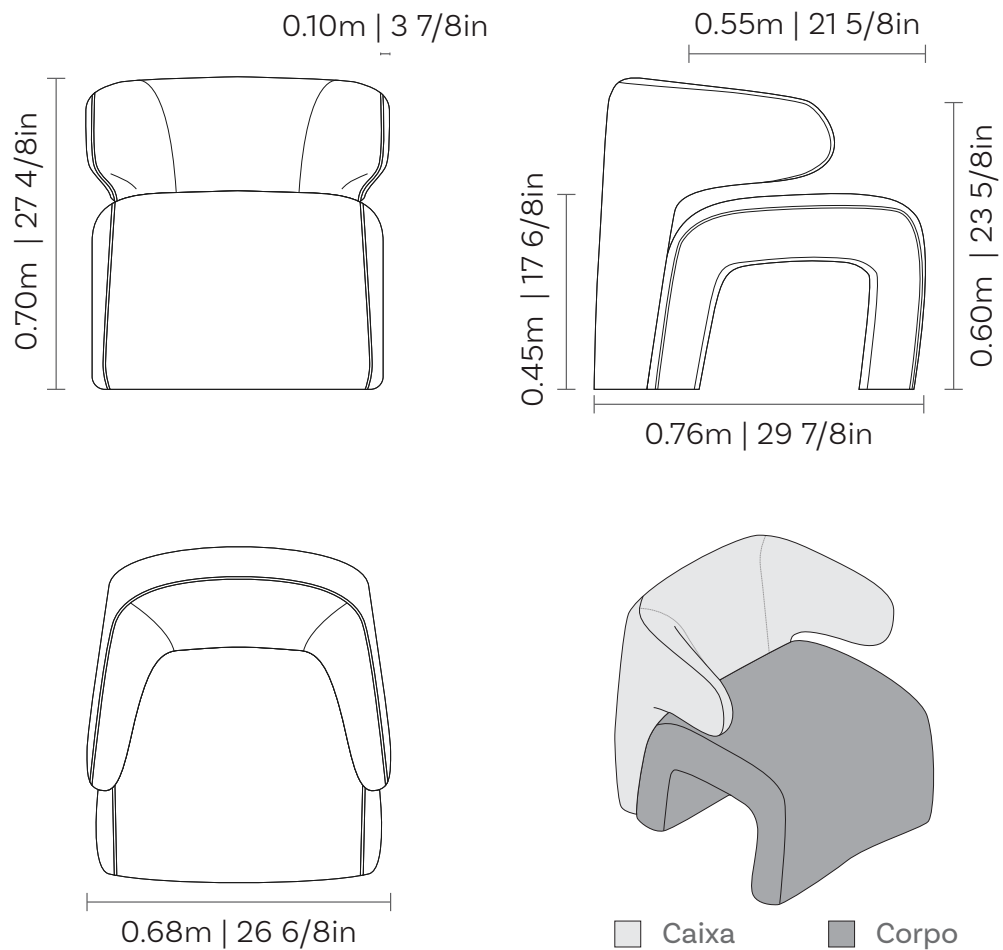

Assento, encosto e braços fixos. Assento com costura em pesponto simples. Encosto e braços com costura em pesponto duplo e pesponto simples. Pés niveladores em aço carbono.



Orbe



POLTRONAS
ARMCHAIR | SILLONES

ponto**vírgula**



Orbe

POLTRONAS
ARMCHAIR | SILLONES



Orbe

POLTRONAS
ARMCHAIR | SILLONES

TECIDO 3D

Poltrona armchair | sillone

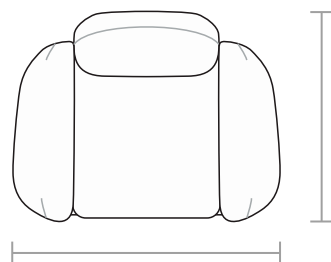
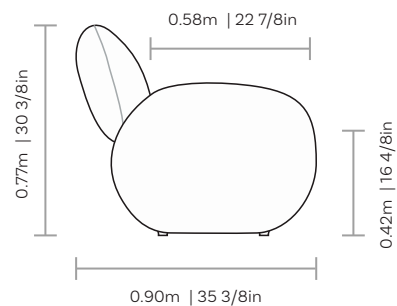

DIMENSÕES
DIMENSIONS | DIMENSIONES

1.17m x 0.90m | 46 1/8in x 35 3/8in

Puff ottoman | puff

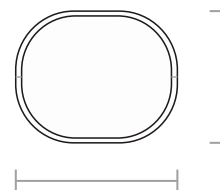
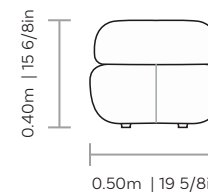
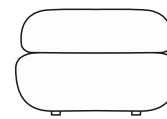

DIMENSÕES
DIMENSIONS | DIMENSIONES

0.62m x 0.50m | 24 3/8in x 19 5/8in

Assento fixos com costura em pesponto simples. Encosto fixo com costura em pesponto simples, pesponto duplo e fechamento com zíper. Braços fixos, com costura em pesponto simples e duplo. Almofada de assento com costura em pesponto simples, espumas em eco-espuma, D26 e D20 soft, envoltas em manta siliconada. Opção de suporte fixo, com pés em polipropileno, ou base giratória, em aço carbono na cor MTX preto.



Orbe

POLTRONAS
ARMCHAIR | SILLONES

COSTURA NO TECIDO PADRÃO

Poltrona armchair | sillone

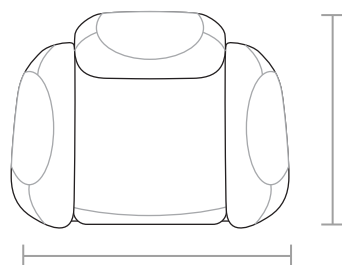
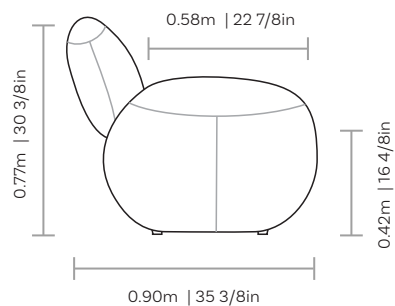

DIMENSÕES
DIMENSIONS | DIMENSIONES

1.17m x 0.90m | 46 1/8in x 35 3/8in

Puff ottoman | puff

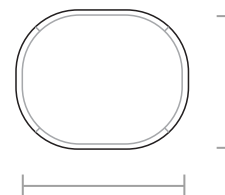
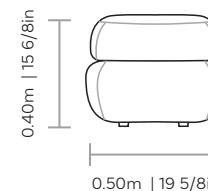
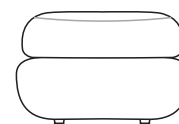

DIMENSÕES
DIMENSIONS | DIMENSIONES

0.62m x 0.50m | 24 3/8in x 19 5/8in

Assento fixos com costura em pesponto simples. Encosto fixo com costura em pesponto simples, pesponto duplo e fechamento com zíper. Braços fixos, com costura em pesponto simples e duplo. Almofada de assento com costura em pesponto simples, espumas em eco-espuma, D26 e D20 soft, envoltas em manta siliconada. Opção de suporte fixo, com pés em polipropileno, ou base giratória, em aço carbono na cor MTX preto.



Oris



POLTRONAS
ARMCHAIR | SILLONES

pontovírgula



Oris

POLTRONAS
ARMCHAIR | SILLONES



Oris

POLTRONAS
ARMCHAIR | SILLONES

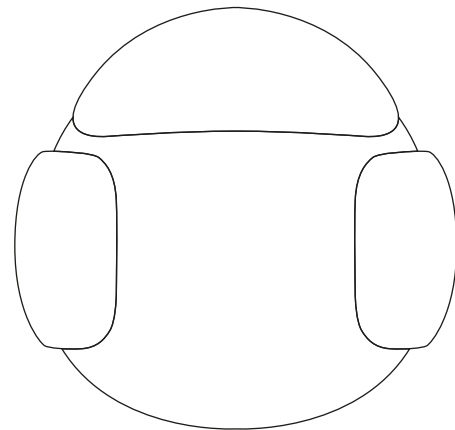
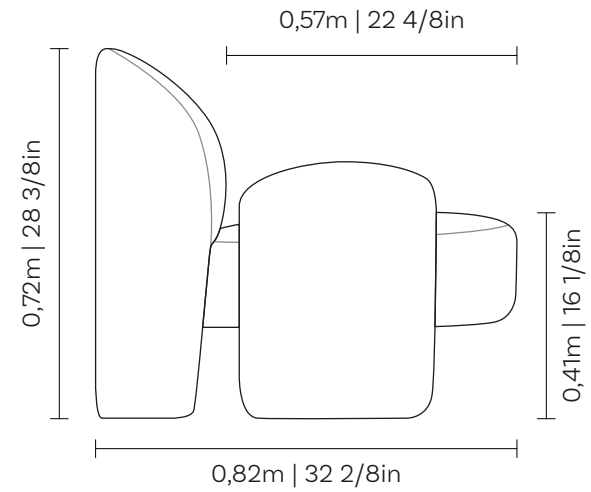
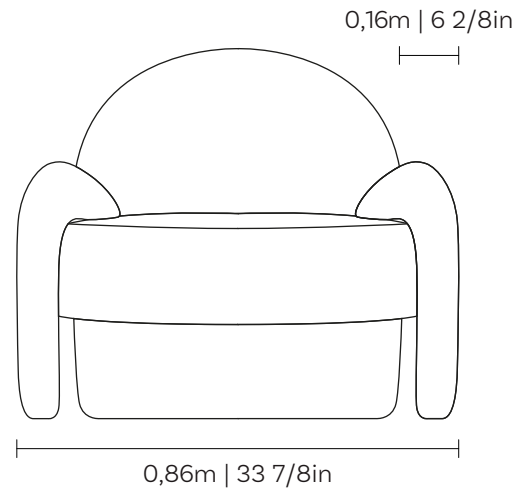

Oris

POLTRONAS
ARMCHAIR | SILLONES

Encoto: Fixo, com costura em pesponto simples.

Braço: Fixo, com costura em pesponto simples.

Assento: Fixo, com costura em pesponto simples.

Medidas podem apresentar leves variações. Nos reservamos o direito de efetuar alterações sem consulta prévia.

Backrest: Fixed, with simple topstitching.

Arm: Fixed, with simple topstitching.

Seat: Fixed, with simple topstitching.

Measures may vary slightly. We reserve the right to make changes without prior consultation.

*For more information, see our Comfort Guide.

Respaldo: Fijo, con costura de pespunte simple.

Braço: Fijo, con costura de pespunte simple.

Asiento: Fijo, con costura de pespunte simple.

Las medidas pueden variar un poco. Nos reservamos el derecho de realizar cambios sin previa consulta.

*Para más informaciones, consulte nuestro Guía de Confort.



Perry



POLTRONAS
ARMCHAIR | SILLONES

ponto**vírgula**



Perry

POLTRONAS
ARMCHAIR | SILLONES



Perry

POLTRONAS
ARMCHAIR | SILLONES

base giratória

swivel base | base giratoria

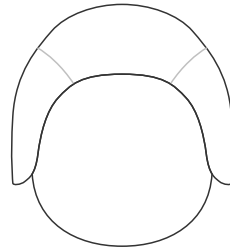
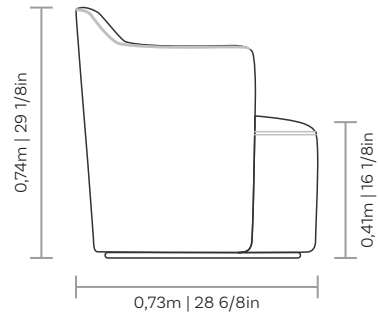
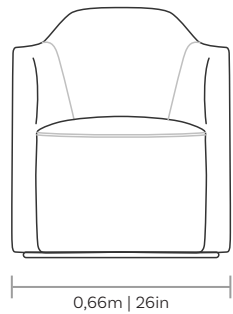

base fixa

fixed base | base fija

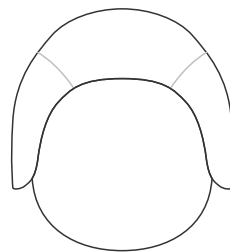
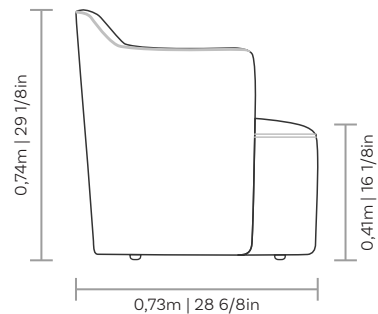
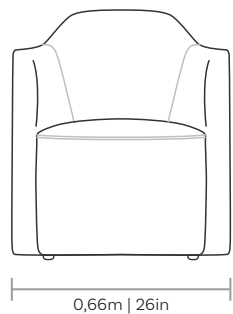

Perry

POLTRONAS
ARMCHAIR | SILLONES

Assento: fixo, com costura em pesponto simples
Encosto: fixo, com costura em pesponto duplo e debrum.
Braço: fixo, com costura em pesponto duplo e debrum.
Suporte: base giratória em aço carbono no acabamento MTX na cor preta ou pé em polipropileno injetado na cor preta.

Medidas podem apresentar leves variações. Nos reservamos o direito de efetuar alterações sem consulta prévia.

Seat: fixed, with simple stitching.
Backrest: fixed, with double stitching and piping.
Armrests: fixed, with double stitching and piping.
Support: swivel base in carbon steel in MTX finish in black color or foot in injected polypropylene in black color.

Measures may vary slightly. We reserve the right to make changes without prior consultation.
*For more information, see our Comfort Guide.

Asiento: fijo, con costuras simples.
Respaldo: Fijo, con doble pespunte y ribete.
Brazo: Fijo, con doble pespunte y ribete.
Soporte: base giratoria en acero al carbono en acabado MTX en color negro o pata en polipropileno inyectado en color negro.

Las medidas pueden variar un poco. Nos reservamos el derecho de realizar cambios sin previa consulta.
*Para más informaciones, consulte nuestro Guía de Comfort.



Sense



POLTRONAS
ARMCHAIR | SILLONES

ponto**vírgula**



Sense

POLTRONAS
ARMCHAIR | SILLONES

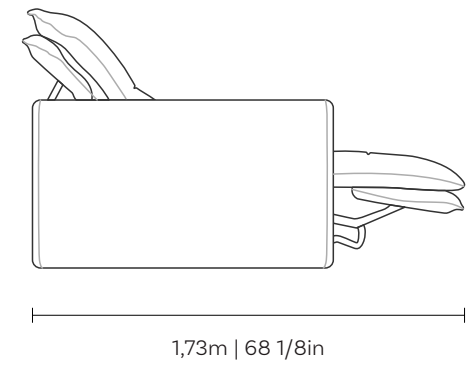
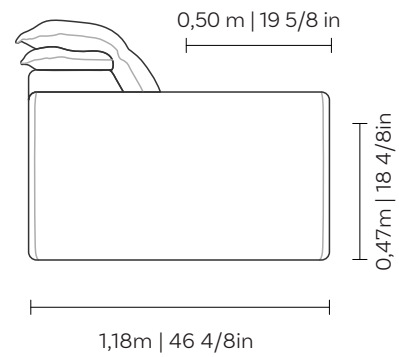
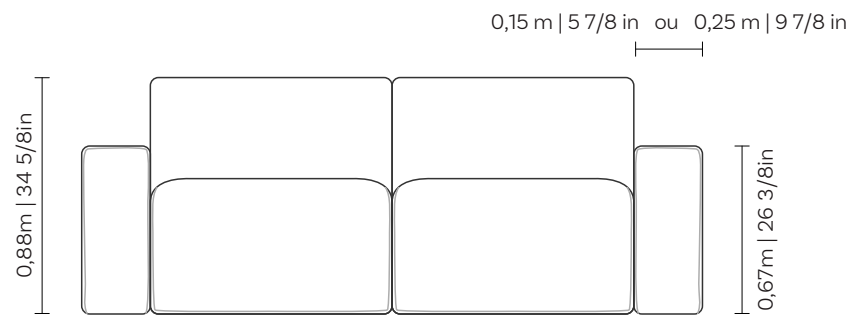

Sense

POLTRONAS
ARMCHAIR | SILLONES

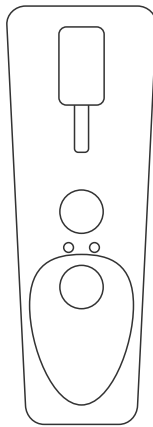

Console Angular
40 cm | 15 6/8 in
com ou sem acessórios

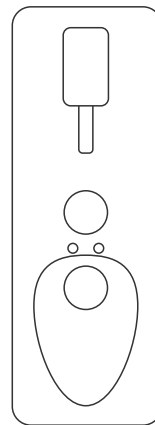

Console Reto
40 cm | 15 6/8 in
com ou sem acessórios

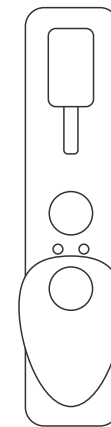

Console Reto
25 cm | 15 6/8 in
com ou sem acessórios



Sense

POLTRONAS
ARMCHAIR | SILLONES

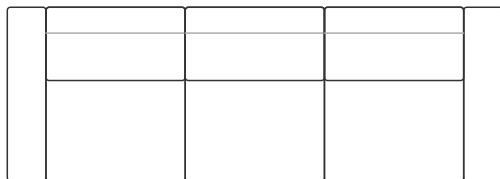

1B 1AS + SB 1AS + 1B 1AS (BRAÇO: 15 OU 25CM) ASS
0,80 x 1,12 m | 31 4/8 in x 44 1/8 in 3
0,90 x 1,12 m | 35 3/8 in x 44 1/8 in 3
1,10 x 1,12 m | 43 2/8 in x 44 1/8 in 3

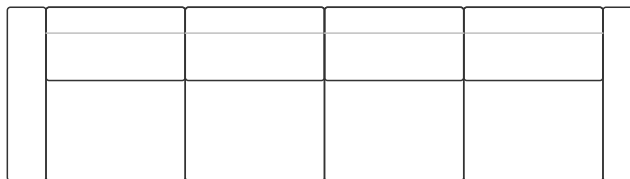

1B 1AS + SB 1AS + SB 1AS + 1B 1AS (BRAÇO: 15 OU 25CM) ASS
0,80 x 1,12 m | 31 4/8 in x 44 1/8 in 4
0,90 x 1,12 m | 35 3/8 in x 44 1/8 in 4
1,10 x 1,12 m | 43 2/8 in x 44 1/8 in 4

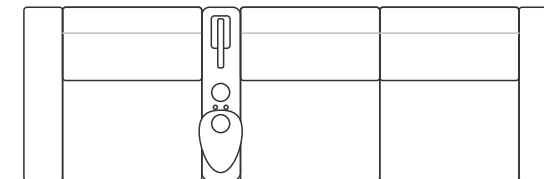

1B + SB CONSOLE + 1B (BRAÇO: 15 OU 25CM) (FORM. CONSOLE: RETO OU ANGULAR) (COMP. CONSOLE: 25 OU 40CM) (LAD. CONSOLE: DIREITO OU ESQUERDO) ASS
0,80 x 1,12 m | 31 4/8 in x 44 1/8 in 3
0,90 x 1,12 m | 35 3/8 in x 44 1/8 in 3
1,10 x 1,12 m | 43 2/8 in x 44 1/8 in 3

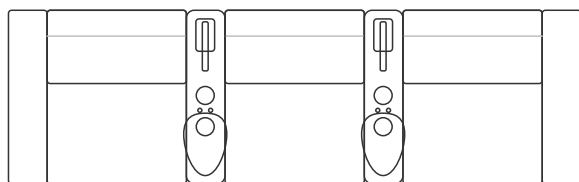

1B + SB CONSOLE + CONSOLE + 1B (BRAÇO: 15 OU 25CM) (FORM. CONSOLE: RETO OU ANGULAR) (COMP. CONSOLE: 25 OU 40CM) ASS
0,80 x 1,12 m | 31 4/8 in x 44 1/8 in 3
0,90 x 1,12 m | 35 3/8 in x 44 1/8 in 3
1,10 x 1,12 m | 43 2/8 in x 44 1/8 in 3

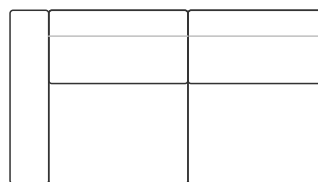

1B 1AS + SB 1AS (BRAÇO: 15 OU 25 CM) ASS
0,80 x 1,12 m | 31 4/8 in x 44 1/8 in 2
0,90 x 1,12 m | 35 3/8 in x 44 1/8 in 2
1,10 x 1,12 m | 43 2/8 in x 44 1/8 in 2

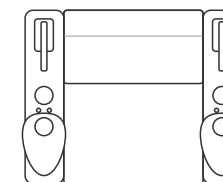

SB CONSOLE + CONSOLE (FORM. CONSOLE: RETO OU ANGULAR) (COMP. CONSOLE: 25 OU 40CM) ASS
0,80 x 1,12 m | 31 4/8 in x 44 1/8 in 1
0,90 x 1,12 m | 35 3/8 in x 44 1/8 in 1
1,10 x 1,12 m | 43 2/8 in x 44 1/8 in 1



Sense

POLTRONAS
ARMCHAIR | SILLONES

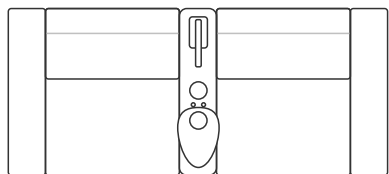

1B + CONSOLE + 1B (BRAÇO: 15 OU 25CM) (FORM. CONSOLE: RETO OU ANGULAR) (COMP. CONSOLE: 25 OU 40CM)

0,80 x 1,12 m | 31 4/8 in x 44 1/8 in
0,90 x 1,12 m | 35 3/8 in x 44 1/8 in
1,10 x 1,12 m | 43 2/8 in x 44 1/8 in

ASS
1
1
1

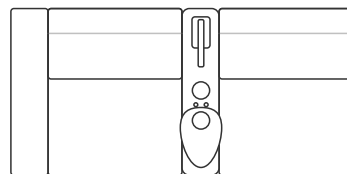

1B + SB CONSOLE (LAD. BRAÇO: DIREITO OU ESQUERDO) (BRAÇO: 15 OU 25CM) (FORM. CONSOLE: RETO OU ANGULAR) (COMP. CONSOLE: 25 OU 40CM) (LAD. CONSOLE: DIREITO OU ESQUERDO)

0,80 x 1,12 m | 31 4/8 in x 44 1/8 in
0,90 x 1,12 m | 35 3/8 in x 44 1/8 in
1,10 x 1,12 m | 43 2/8 in x 44 1/8 in

ASS
2
2
2

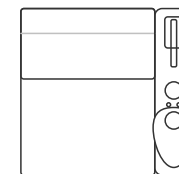

SB CONSOLE (FORM. CONSOLE: RETO OU ANGULAR) (COMP. CONSOLE: 25 OU 40CM) (LAD. CONSOLE: DIREITO OU ESQUERDO)

0,80 x 1,12 m | 31 4/8 in x 44 1/8 in
0,90 x 1,12 m | 35 3/8 in x 44 1/8 in
1,10 x 1,12 m | 43 2/8 in x 44 1/8 in

ASS
1
1
1

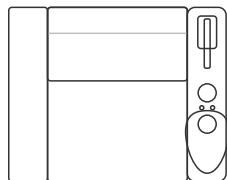

1B + CONSOLE (LAD. BRAÇO: DIREITO OU ESQUERDO) (BRAÇO: 15 OU 25CM) (FORM. CONSOLE: RETO OU ANGULAR) (COMP. CONSOLE: 25 OU 40CM) (LAD. CONSOLE: DIREITO OU ESQUERDO)

0,80 x 1,12 m | 31 4/8 in x 44 1/8 in
0,90 x 1,12 m | 35 3/8 in x 44 1/8 in
1,10 x 1,12 m | 43 2/8 in x 44 1/8 in

ASS
1
1
1

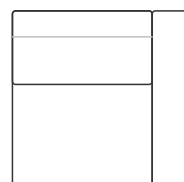

1B 1AS (LAD. BRAÇO: DIREITO OU ESQUERDO) (BRAÇO: 15 OU 25CM)

0,80 x 1,12 m | 31 4/8 in x 44 1/8 in
0,90 x 1,12 m | 35 3/8 in x 44 1/8 in
1,10 x 1,12 m | 43 2/8 in x 44 1/8 in

ASS
1
1
1

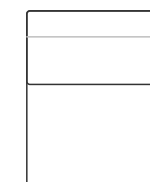

SB 1AS

0,80 x 1,12 m | 31 4/8 in x 44 1/8 in
0,90 x 1,12 m | 35 3/8 in x 44 1/8 in
1,10 x 1,12 m | 43 2/8 in x 44 1/8 in

ASS
1
1
1



Sense

POLTRONAS
ARMCHAIR | SILLONES

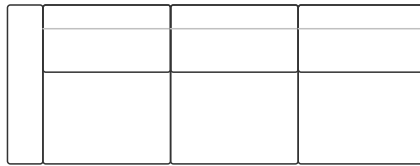

**1B 1AS + SB 1AS + SB 1AS (LAD. BRAÇO: DIREITO OU ESQUERDO)
(BRAÇO: 15 OU 25CM)**

0,80 x 1,12 m | 31 4/8 in x 44 1/8 in
0,90 x 1,12 m | 35 3/8 in x 44 1/8 in
1,10 x 1,12 m | 43 2/8 in x 44 1/8 in

ASS
3
3
3

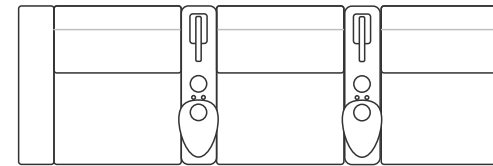

**1B + SB CONSOLE + SB CONSOLE (LAD. BRAÇO: DIREITO OU
ESQUERDO) (BRAÇO: 15 OU 25CM) (FORM. CONSOLE: RETO OU
ANGULAR) (COMP. CONSOLE: 25 OU 40CM)**

0,80 x 1,12 m | 31 4/8 in x 44 1/8 in
0,90 x 1,12 m | 35 3/8 in x 44 1/8 in
1,10 x 1,12 m | 43 2/8 in x 44 1/8 in

ASS
3
3
3



**CONSOLE (FORM. CONSOLE: RETO OU ANGULAR) (COMP.
CONSOLE: 25 OU 40CM)**



Sense

POLTRONAS
ARMCHAIR | SILLONES

Assento: reclinável e costura em pesponto simples e fole.

Encosto: reclinável com costura em fole.

Braço: fixo com costura em fole.

Observações:

O console apresenta vários opcionais:

Opção sem ou com mesa, essa podendo ser manual ou motorizada, disponível nos acabamentos laminado e laminado especial.

Opção de luminária.

Opção de porta copo.

Esses itens opcionais serão posicionados sempre no mesmo lugar definido.

Medidas podem apresentar leves variações. Nos reservamos o direito de efetuar alterações sem consulta prévia.

Seat: reclining and stitching in simple topstitching and bellows.

Backrest: reclining with bellows stitching.

Armrest: fixed with bellows stitching.

Observations:

The console features several options:

Option without or with table, this can be manual or motorized, available in laminate and special laminate finishes.

Lamp option.

Cup holder option.

These optional items will always be positioned in the same defined place.

Measures may vary slightly. We reserve the right to make changes without prior consultation.

*For more information, see our Comfort Guide.

Asiento: reclinable y cosido en pespuntos y fuelles sencillos.

Respaldo: reclinable con costuras de fuelle.

Brazo: fijo con costuras de fuelle.

Observaciones:

La consola cuenta con varias opciones:

Opción sin o con mesa, puede ser manual o motorizada, disponible en laminado y acabados laminados especiales.

Opción de lámpara.

Opción de portavasos.

Estos elementos opcionales siempre se colocarán en el mismo lugar definido.

Las medidas pueden variar un poco. Nos reservamos el derecho de realizar cambios sin previa consulta.

*Para más informaciones, consulte nuestro Guía de Confort.



Sense



POLTRONAS
ARMCHAIR | SILLONES

ponto**vírgula**



Sense

POLTRONAS
ARMCHAIR | SILLONES

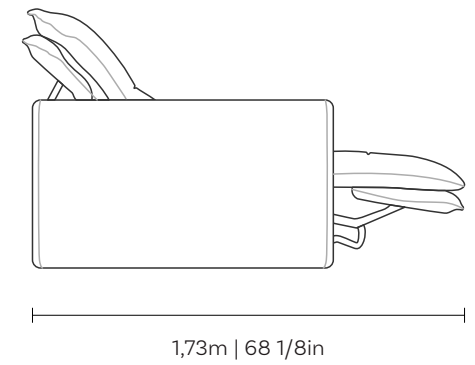
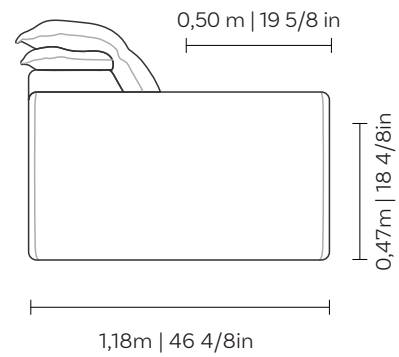
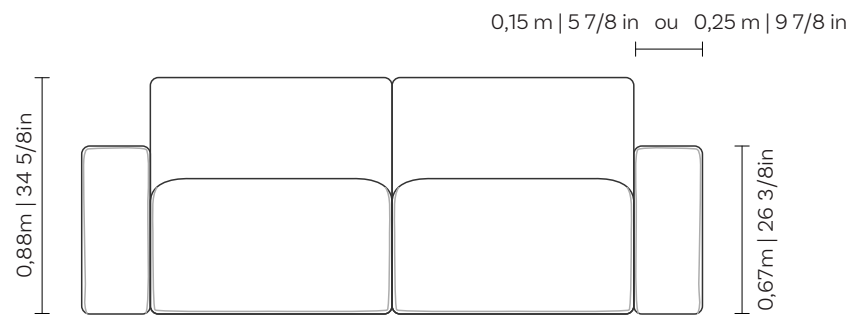

Sense

POLTRONAS
ARMCHAIR | SILLONES

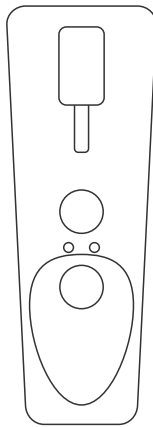

Console Angular
40 cm | 15 6/8 in
com ou sem acessórios

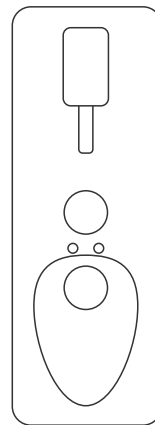

Console Reto
40 cm | 15 6/8 in
com ou sem acessórios

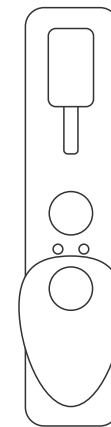

Console Reto
25 cm | 15 6/8 in
com ou sem acessórios



Sense

POLTRONAS
ARMCHAIR | SILLONES

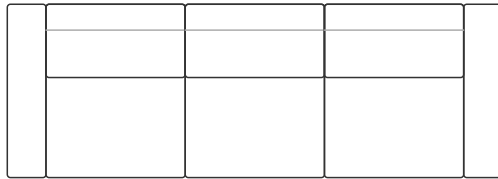

1B 1AS + SB 1AS + 1B 1AS (BRAÇO: 15 OU 25CM) ASS
 0,80 x 1,12 m | 31 4/8 in x 44 1/8 in 3
 0,90 x 1,12 m | 35 3/8 in x 44 1/8 in 3
 1,10 x 1,12 m | 43 2/8 in x 44 1/8 in 3

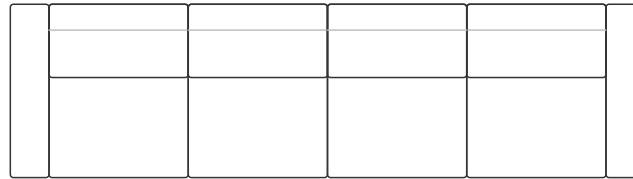

1B 1AS + SB 1AS + SB 1AS + 1B 1AS (BRAÇO: 15 OU 25CM) ASS
 0,80 x 1,12 m | 31 4/8 in x 44 1/8 in 4
 0,90 x 1,12 m | 35 3/8 in x 44 1/8 in 4
 1,10 x 1,12 m | 43 2/8 in x 44 1/8 in 4

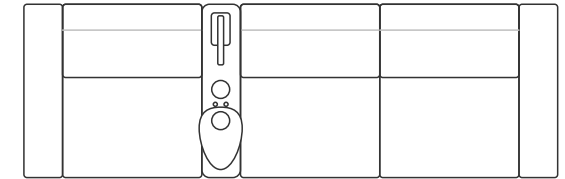

1B + SB CONSOLE + 1B (BRAÇO: 15 OU 25CM) (FORM. CONSOLE: RETO OU ANGULAR) (COMP. CONSOLE: 25 OU 40CM) (LAD. CONSOLE: DIREITO OU ESQUERDO) ASS
 0,80 x 1,12 m | 31 4/8 in x 44 1/8 in 3
 0,90 x 1,12 m | 35 3/8 in x 44 1/8 in 3
 1,10 x 1,12 m | 43 2/8 in x 44 1/8 in 3

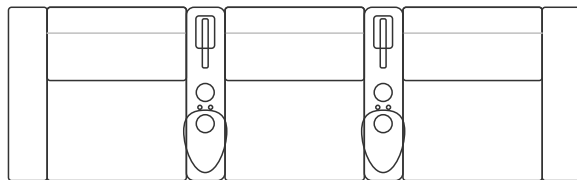

1B + SB CONSOLE + CONSOLE + 1B (BRAÇO: 15 OU 25CM) (FORM. CONSOLE: RETO OU ANGULAR) (COMP. CONSOLE: 25 OU 40CM) ASS
 0,80 x 1,12 m | 31 4/8 in x 44 1/8 in 3
 0,90 x 1,12 m | 35 3/8 in x 44 1/8 in 3
 1,10 x 1,12 m | 43 2/8 in x 44 1/8 in 3

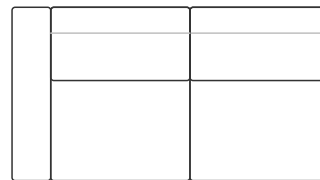

1B + CONSOLE + 1B (BRAÇO: 15 OU 25CM) (FORM. CONSOLE: RETO OU ANGULAR) (COMP. CONSOLE: 25 OU 40CM) ASS
 0,80 x 1,12 m | 31 4/8 in x 44 1/8 in 2
 0,90 x 1,12 m | 35 3/8 in x 44 1/8 in 2
 1,10 x 1,12 m | 43 2/8 in x 44 1/8 in 2

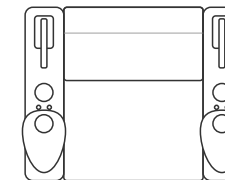

SB CONSOLE + CONSOLE (FORM. CONSOLE: RETO OU ANGULAR) (COMP. CONSOLE: 25 OU 40CM) ASS
 0,80 x 1,12 m | 31 4/8 in x 44 1/8 in 1
 0,90 x 1,12 m | 35 3/8 in x 44 1/8 in 1
 1,10 x 1,12 m | 43 2/8 in x 44 1/8 in 1



Sense

POLTRONAS ARMCHAIR | SILLONES

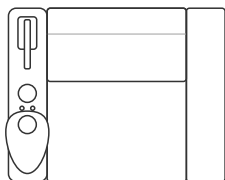

1B + CONSOLE + 1B (BRAÇO: 15 OU 25CM) (FORM. CONSOLE: RETO OU ANGULAR) (COMP. CONSOLE: 25 OU 40CM)

0,80 x 1,12 m | 31 4/8 in x 44 1/8 in
0,90 x 1,12 m | 35 3/8 in x 44 1/8 in
1,10 x 1,12 m | 43 2/8 in x 44 1/8 in

ASS
1
1
1

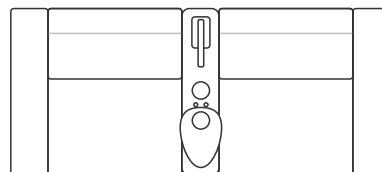

1B + SB CONSOLE (LAD. BRAÇO: DIREITO OU ESQUERDO) (BRAÇO: 15 OU 25CM) (FORM. CONSOLE: RETO OU ANGULAR) (COMP. CONSOLE: 25 OU 40CM) (LAD. CONSOLE: DIREITO OU ESQUERDO)

0,80 x 1,12 m | 31 4/8 in x 44 1/8 in
0,90 x 1,12 m | 35 3/8 in x 44 1/8 in
1,10 x 1,12 m | 43 2/8 in x 44 1/8 in

ASS
2
2
2

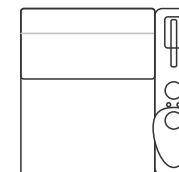

SB CONSOLE (FORM. CONSOLE: RETO OU ANGULAR) (COMP. CONSOLE: 25 OU 40CM) (LAD. CONSOLE: DIREITO OU ESQUERDO)

0,80 x 1,12 m | 31 4/8 in x 44 1/8 in
0,90 x 1,12 m | 35 3/8 in x 44 1/8 in
1,10 x 1,12 m | 43 2/8 in x 44 1/8 in

ASS
1
1
1

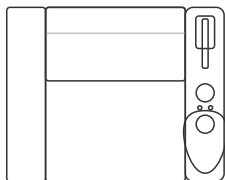

1B + CONSOLE (LAD. BRAÇO: DIREITO OU ESQUERDO) (BRAÇO: 15 OU 25CM) (FORM. CONSOLE: RETO OU ANGULAR) (COMP. CONSOLE: 25 OU 40CM) (LAD. CONSOLE: DIREITO OU ESQUERDO)

0,80 x 1,12 m | 31 4/8 in x 44 1/8 in
0,90 x 1,12 m | 35 3/8 in x 44 1/8 in
1,10 x 1,12 m | 43 2/8 in x 44 1/8 in

ASS
1
1
1

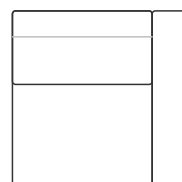

1B 1AS (LAD. BRAÇO: DIREITO OU ESQUERDO) (BRAÇO: 15 OU 25CM)

0,80 x 1,12 m | 31 4/8 in x 44 1/8 in
0,90 x 1,12 m | 35 3/8 in x 44 1/8 in
1,10 x 1,12 m | 43 2/8 in x 44 1/8 in

ASS
1
1
1

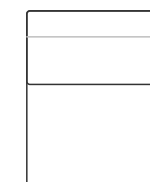

SB 1AS

0,80 x 1,12 m | 31 4/8 in x 44 1/8 in
0,90 x 1,12 m | 35 3/8 in x 44 1/8 in
1,10 x 1,12 m | 43 2/8 in x 44 1/8 in

ASS
1
1
1



Sense

POLTRONAS
ARMCHAIR | SILLONES

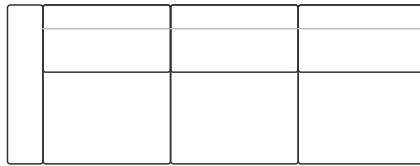

**1B 1AS + SB 1AS + SB 1AS (LAD. BRAÇO: DIREITO OU ESQUERDO)
(BRAÇO: 15 OU 25CM)**

0,80 x 1,12 m | 31 4/8 in x 44 1/8 in
0,90 x 1,12 m | 35 3/8 in x 44 1/8 in
1,10 x 1,12 m | 43 2/8 in x 44 1/8 in

ASS
3
3
3

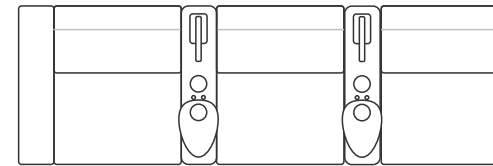

**1B + SB CONSOLE + SB CONSOLE (LAD. BRAÇO: DIREITO OU
ESQUERDO) (BRAÇO: 15 OU 25CM) (FORM. CONSOLE: RETO OU
ANGULAR) (COMP. CONSOLE: 25 OU 40CM)**

0,80 x 1,12 m | 31 4/8 in x 44 1/8 in
0,90 x 1,12 m | 35 3/8 in x 44 1/8 in
1,10 x 1,12 m | 43 2/8 in x 44 1/8 in

ASS
3
3
3



**CONSOLE (FORM. CONSOLE: RETO OU ANGULAR) (COMP.
CONSOLE: 25 OU 40CM)**



Sense

POLTRONAS
ARMCHAIR | SILLONES

Assento: reclinável e costura em pesponto simples e fole.
Encosto: reclinável com costura em fole.
Braço: fixo com costura em fole.
Observações:
O console apresenta vários opcionais:
Opção sem ou com mesa, essa podendo ser manual ou motorizada, disponível nos acabamentos laminado e laminado especial.
Opção de luminária.
Opção de porta copo.
Esses itens opcionais serão posicionados sempre no mesmo lugar definido.

Seat: reclining and stitching in simple topstitching and bellows.
Backrest: reclining with bellows stitching.
Armrest: fixed with bellows stitching.
Observations:
The console features several options:
Option without or with table, this can be manual or motorized, available in laminate and special laminate finishes.
Lamp option.
Cup holder option.
These optional items will always be positioned in the same defined place.

Measures may vary slightly. We reserve the right to make changes without prior consultation.

*For more information, see our Comfort Guide.

Medidas podem apresentar leves variações. Nos reservamos o direito de efetuar alterações sem consulta prévia.

Asiento: reclinable y cosido en pespuntos y fuelles sencillos.
Respaldo: reclinable con costuras de fuelle.
Brazo: fijo con costuras de fuelle.
Observaciones:
La consola cuenta con varias opciones:
Opción sin o con mesa, puede ser manual o motorizada, disponible en laminado y acabados laminados especiales.
Opción de lámpara.
Opción de portavasos.
Estos elementos opcionales siempre se colocarán en el mismo lugar definido.

Las medidas pueden variar un poco. Nos reservamos el derecho de realizar cambios sin previa consulta.

*Para más informaciones, consulte nuestro Guía de Confort.



ponto**vírgula**

Sona



POLTRONAS
ARMCHAIR | SILLONES

ponto**vírgula**
+
Persch Objects



Sona

POLTRONAS
ARMCHAIR | SILLONES



ponto**vírgula**
+ Persch Objects

Sona

POLTRONAS
ARMCHAIR | SILLONES

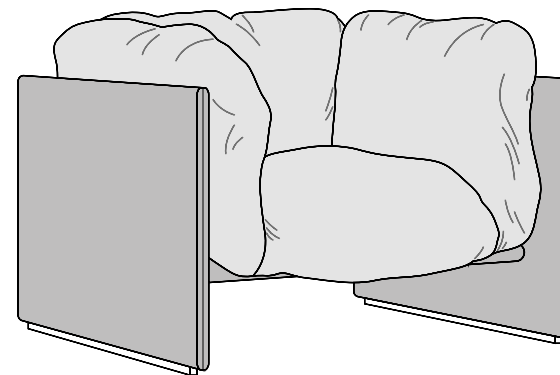
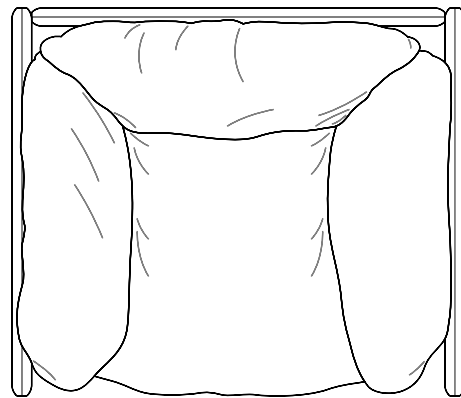
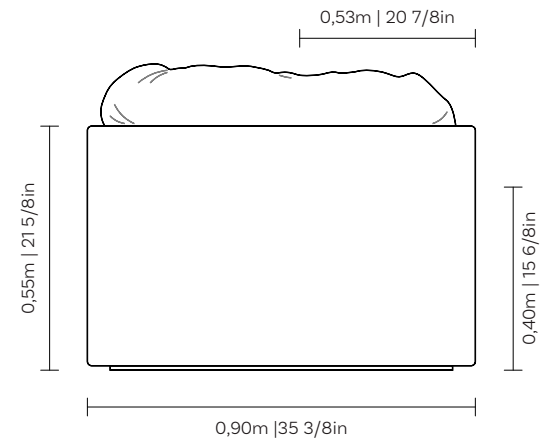
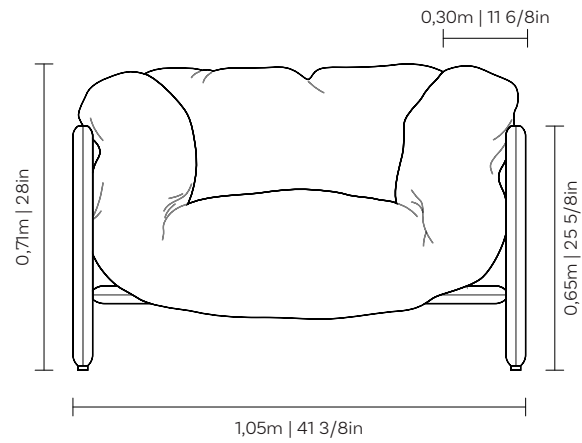

ponto**vírgula**
+ Persch Objects

Sona

POLTRONAS
ARMCHAIR | SILLONES

Caixa de Assento: Fixa, sem detalhe de costura.

Caixa de Encosto: Fixa, sem detalhe de costura.

Braço: Fixo, com costura em debrum.

Imofadas de Assento: Solta, dem detlahe de costura.

Almofadas de Encosto: Solta, dem detlahe de costura.

Almofadas de Braço: Solta, dem detlahe de costura.

Suporte: em aço carbono, disponível no acabamento pintura MTX preta.

Obs.: almofadas unidas entre elas e soltas da estrutura, possibilitando ser removida e recolocada no lugar, podendo haver divergências dimensionais.

Medidas podem apresentar leves variações. Nos reservamos o direito de efetuar alterações sem consulta prévia.



Seat Box: Fixed, without stitching details.

Backrest Box: Fixed, without stitching details.

Arm: Fixed, with piping trim stitching.

Seat Cushions: Loose, without stitching details.

Back Cushions: Loose, without stitching details.

Arm Cushions: Loose, without stitching details.

Support: Carbon steel, available in MTX paint, metallic paint, and matte paint finishes.

Note: The cushions are attached to each other but loose from the structure, allowing them to be removed and repositioned; dimensional variations may occur.

Measures may vary slightly. We reserve the right to make changes without prior consultation.

*For more information, see our Comfort Guide.

Caja de Asiento: Fija, sin detalle de costura.

Caja de Respaldo: Fija, sin detalle de costura.

Brazo: Fijo, con costura en vivo (ribete).

Cojines de Asiento: Suelos, sin detalle de costura.

Cojines de Respaldo: Suelos, sin detalle de costura.

Cojines de Brazo: Suelos, sin detalle de costura.

Soporte: En acero al carbono, disponible en acabados pintura MTX, pintura metalizada y pintura mate.

Obs.: Los cojines están unidos entre sí y sueltos de la estructura, lo que permite retirarlos y volver a colocarlos en su lugar; pueden existir divergencias dimensionales.

Las medidas pueden variar un poco. Nos reservamos el derecho de realizar cambios sin previa consulta.

*Para más informaciones, consulte nuestro Guía de Confort.

ponto**vírgula**
+
Persch Objects

Spur



POLTRONAS
ARMCHAIR | SILLONES

ponto**vírgula**
+
Persch Objects



Spur

POLTRONAS
ARMCHAIR | SILLONES



ponto**vírgula**
+ Persch Objects

Spur

POLTRONAS
ARMCHAIR | SILLONES

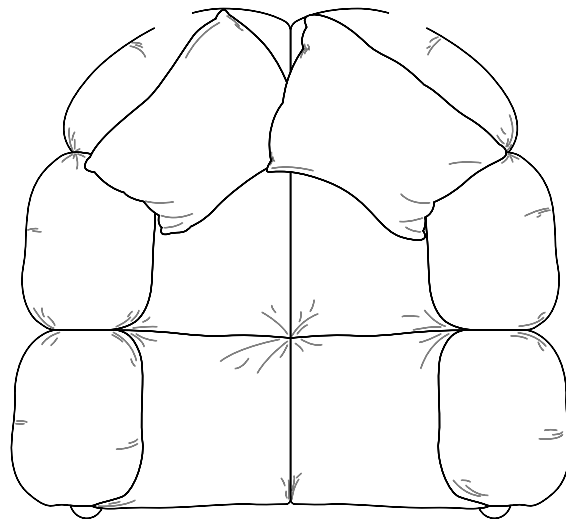
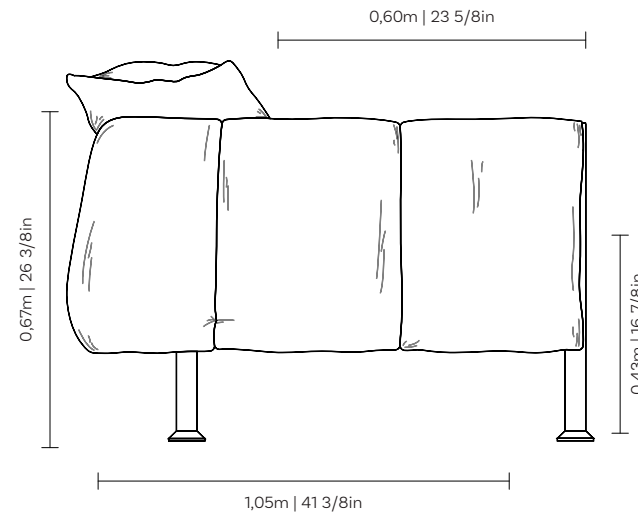
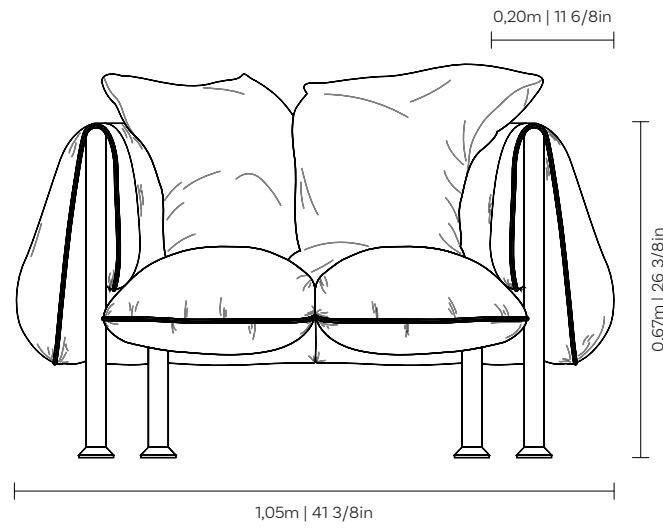

Spur

POLTRONAS
ARMCHAIR | SILLONES

Assento: Solto, com costura em fole
Encosto: Solto, com costura em fole
Braço: Solto, com costura em fole
Almofada Decorativa: Solta, sem detalhe de costura
Suporte: Base em aço carbono, disponível nos acabamentos pintura MTX, pintura fosca e pintura metalizada.

Medidas podem apresentar leves variações. Nos reservamos o direito de efetuar alterações sem consulta prévia.

Seat: Loose, with boxed stitching.
Backrest: Loose, with boxed stitching.
Armrest: Loose, with boxed stitching.
Decorative Cushion: Loose, without stitching details.
Support: Carbon steel base, available in MTX paint, matte paint, and metallic paint finishes.

Measures may vary slightly. We reserve the right to make changes without prior consultation.
*For more information, see our Comfort Guide.

Asiento: Suelto, con costura tipo fuelle.
Respaldo: Suelto, con costura tipo fuelle.
Brazo: Suelto, con costura tipo fuelle.
Cojín Decorativo: Suelto, sin detalle de costura.
Soporte: Base en acero al carbono, disponible en acabados pintura MTX, pintura mate y pintura metalizada.

Las medidas pueden variar un poco. Nos reservamos el derecho de realizar cambios sin previa consulta.
*Para más informaciones, consulte nuestro Guía de Comfort.



Stolz



POLTRONAS
ARMCHAIR | SILLONES

pontovírgula



Stolz

POLTRONAS
ARMCHAIR | SILLONES



Stolz

POLTRONAS
ARMCHAIR | SILLONES

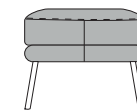
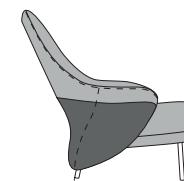
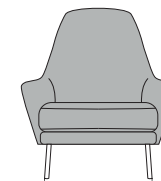
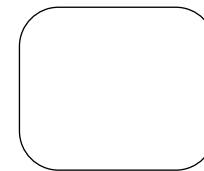
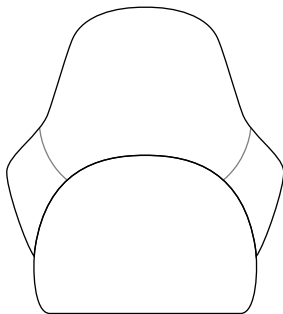
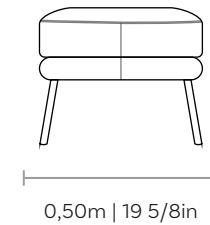
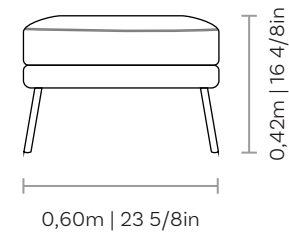
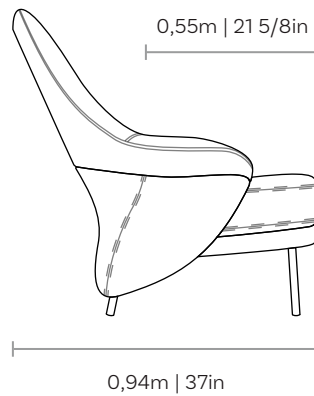
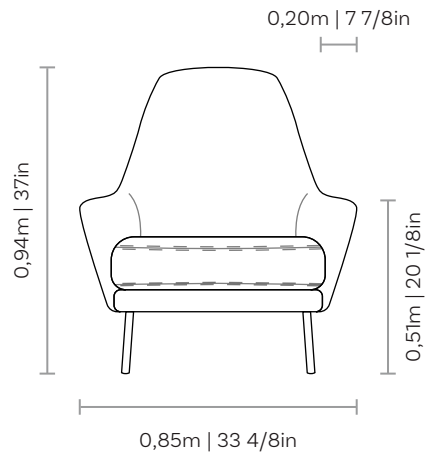

caixa
corpo



pontovírgula

Stolz

POLTRONAS
ARMCHAIR | SILLONES

Assento, encosto e braço com costura em pesponto simples. Casca em fibra revestida nas opções: couro com costura em pesponto duplo ou tecido com costura em pesponto simples. Pés em aço carbono disponíveis nos acabamentos pintura MTX e pintura metalizada.

Medidas podem apresentar leves variações. Nos reservamos o direito de efetuar alterações sem consulta prévia.

Seat, back and arm with simple topstitching. Coated fiber shell in the options: leather with double topstitching or fabric with single topstitching. Carbon steel feet available in MTX paint and metallic paint finishes.

Measures may vary slightly. We reserve the right to make changes without prior consultation.

Asiento, respaldo y brazo con pespuntos sencillos. Exterior de fibra revestida en las opciones: piel con doble pespunte o tela con pespunte simple. Pies de acero al carbono disponibles en acabados de pintura MTX y pintura metalizada.

Las medidas pueden variar un poco. Nos reservamos el derecho de realizar cambios sin previa consulta.



Tess



POLTRONAS
ARMCHAIR | SILLONES

pontovírgula



Tess

POLTRONAS
ARMCHAIR | SILLONES



Tess

POLTRONAS
ARMCHAIR | SILLONES

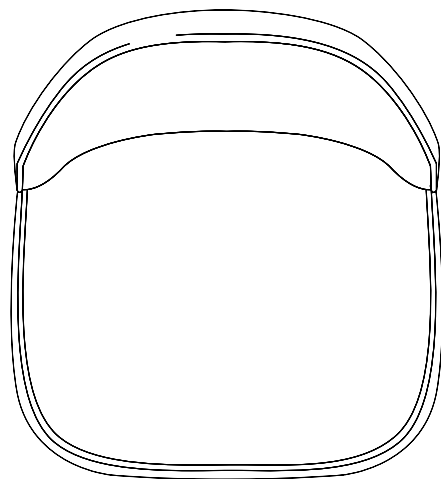
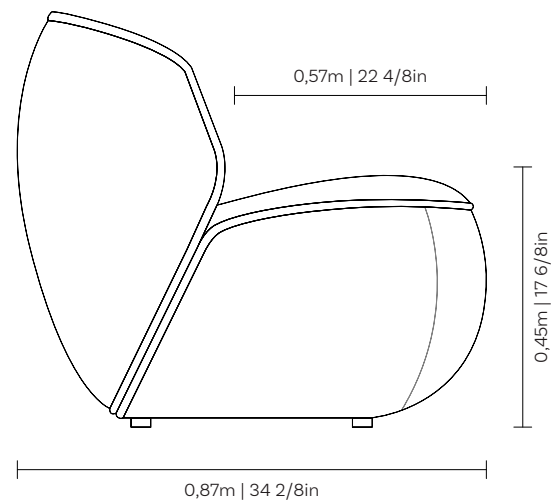
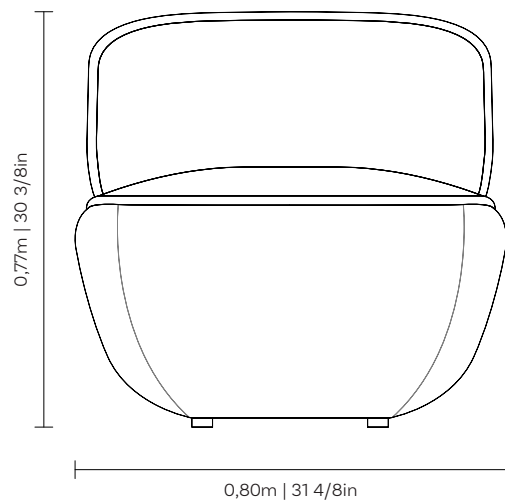

Tess

POLTRONAS
ARMCHAIR | SILLONES

Assento: Fixo, com costura em debrum e pesponto duplo.
Encosto: Fixo, com costura em debrum e pesponto duplo.
Braço: Fixo, com costura em debrum.
Suporte: Opção de suporte fixo, com pés em polipropileno injetado na cor preta, ou base giratória, em aço carbono na cor MTX preto, revestida com tecido

Medidas podem apresentar leves variações. Nos reservamos o direito de efetuar alterações sem consulta prévia.

Seat: Fixed, with piping trim stitching and double topstitching.
Backrest: Fixed, with piping trim stitching and double topstitching.
Arm: Fixed, with piping trim stitching.
Support: Option of a fixed support with injected polypropylene feet in black, or a swivel base in carbon steel in MTX black, upholstered in fabric.

Measures may vary slightly. We reserve the right to make changes without prior consultation.

*For more information, see our Comfort Guide.

Asiento: Fijo, con costura en vivo (ribete) y pespunte doble.
Respaldo: Fijo, con costura en vivo (ribete) y pespunte doble.
Brazo: Fijo, con costura en vivo (ribete).
Soporte: Opción de soporte fijo con patas de polipropileno inyectado en color negro, o base giratoria en acero al carbono en color MTX negro, revestida en tela.

Las medidas pueden variar un poco. Nos reservamos el derecho de realizar cambios sin previa consulta.

*Para más informaciones, consulte nuestro Guía de Confort.



Wass



POLTRONAS
ARMCHAIR | SILLONES

pontovírgula



Wass

POLTRONAS
ARMCHAIR | SILLONES



Wass

POLTRONAS
ARMCHAIR | SILLONES

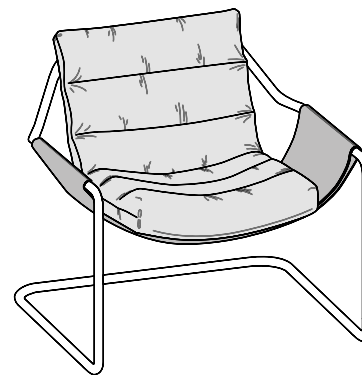
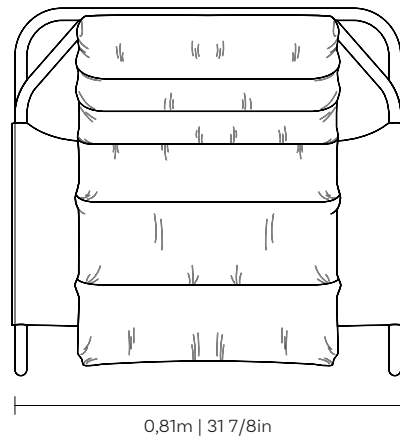
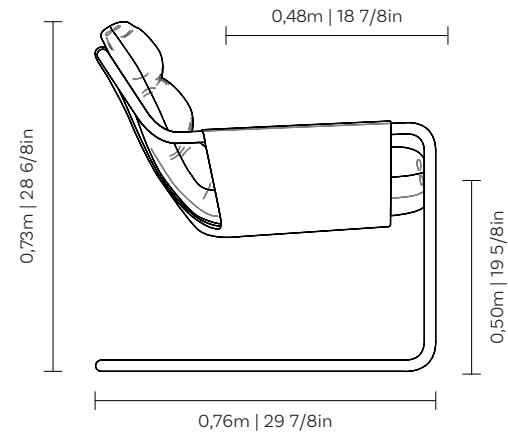
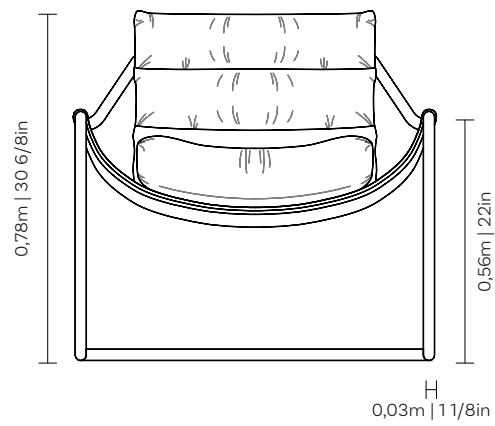

Wass

POLTRONAS
ARMCHAIR | SILLONES

Estrutura: Capa de tecido ou couro, com costura em pesponto simples.

Almofada: Em gomos, sem detalhe de costura.

Suporte: Base em aço carbono, disponível nos acabamentos pintura MTX, pintura fosca e pintura Metalizada.

Obs.: Modelo não apresenta possibilidade de medidas especiais.

Medidas podem apresentar leves variações. Nos reservamos o direito de efetuar alterações sem consulta prévia.

Estrutura: Cubierta de tela o couro, con costura en pespunte simple.

Almohadilla: En gajos, sin detalle de costura.

Suporte: Base de acero al carbono, disponible en acabados pintura MTX, pintura mate y pintura metalizada.

Obs.: El modelo no ofrece posibilidad de medidas especiales.

Measures may vary slightly. We reserve the right to make changes without prior consultation.

*For more information, see our Comfort Guide.

Structure: Fabric or leather cover, with simple topstitching.

Cushion: Channel-stitched, without visible stitching details.

Support: Carbon steel base, available in MTX paint, matte paint, and metallic paint finishes.

Note: This model does not offer the possibility of custom dimensions.

Las medidas pueden variar un poco. Nos reservamos el derecho de realizar cambios sin previa consulta.

*Para más informaciones, consulte nuestro Guía de Confort.



Weg



POLTRONAS
ARMCHAIR | SILLONES

pontovírgula



Weg

POLTRONAS
ARMCHAIR | SILLONES



pontovírgula

Weg

POLTRONAS
ARMCHAIR | SILLONES

base giratória

swivel base | base giratoria

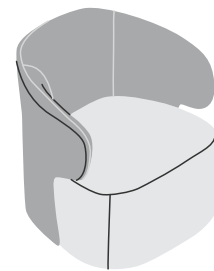
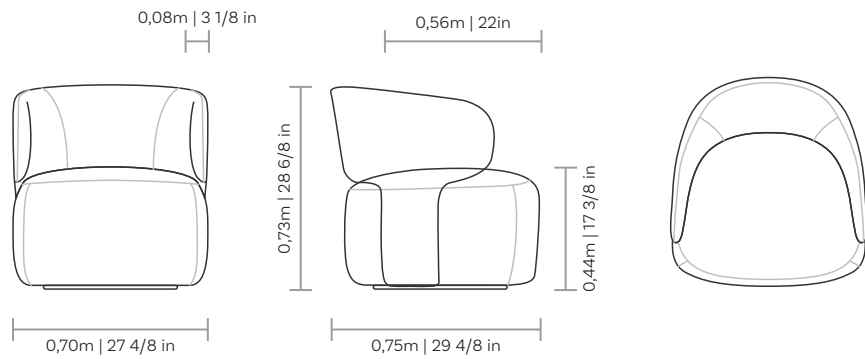

base fixa

fixed base | base fija

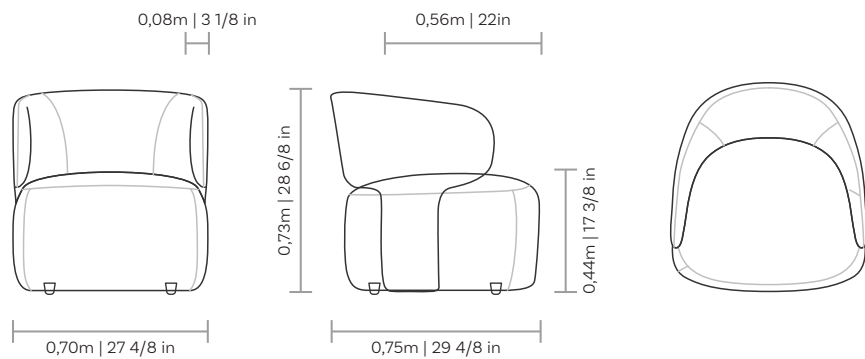

Weg

POLTRONAS
ARMCHAIR | SILLONES

Assento: Fixo, com costura em pesponto simples
Encosto: Fixo, com costura em pesponto simples
Braço: Fixo, com costura em pesponto simples
Suporte: Opção de base giratória, em aço carbono no acabamento MTX na cor preta ou pé em polipropileno injetado na cor preta.

Medidas podem apresentar leves variações. Nos reservamos o direito de efetuar alterações sem consulta prévia.

Seat: fixed, with simple backstich.
Backrest: fixed, with simple backstich.
Armrest: fixed, with simple backstich.
Support: fixed, with black injected polypropylene feet, or swivel base in carbon steel in black microtextured electrostatic painting.

Measures may vary slightly. We reserve the right to make changes without prior consultation.

*For more information, see our Comfort Guide.

Asiento: fijo con costuras simples.
Respaldo: fijo con costuras simples.
Brazos: fijo con costuras simples.
Soporte: fijo, con pies en polipropileno inyectado en color negro, o base giratoria en acero al carbono en color negro MTX, recubierta de tela.

Las medidas pueden variar un poco. Nos reservamos el derecho de realizar cambios sin previa consulta.

*Para más informaciones, consulte nuestro Guía de Confort.



CADEIRAS

CHAIRS | SILLAS

ponto**vírgula**

Sillage



CADEIRAS
CHAIRS | SILLAS

ponto**vírgula**



Sillage

CADEIRAS
CHAIRS | SILLAS



Sillage

CADEIRAS
CHAIRS | SILLAS

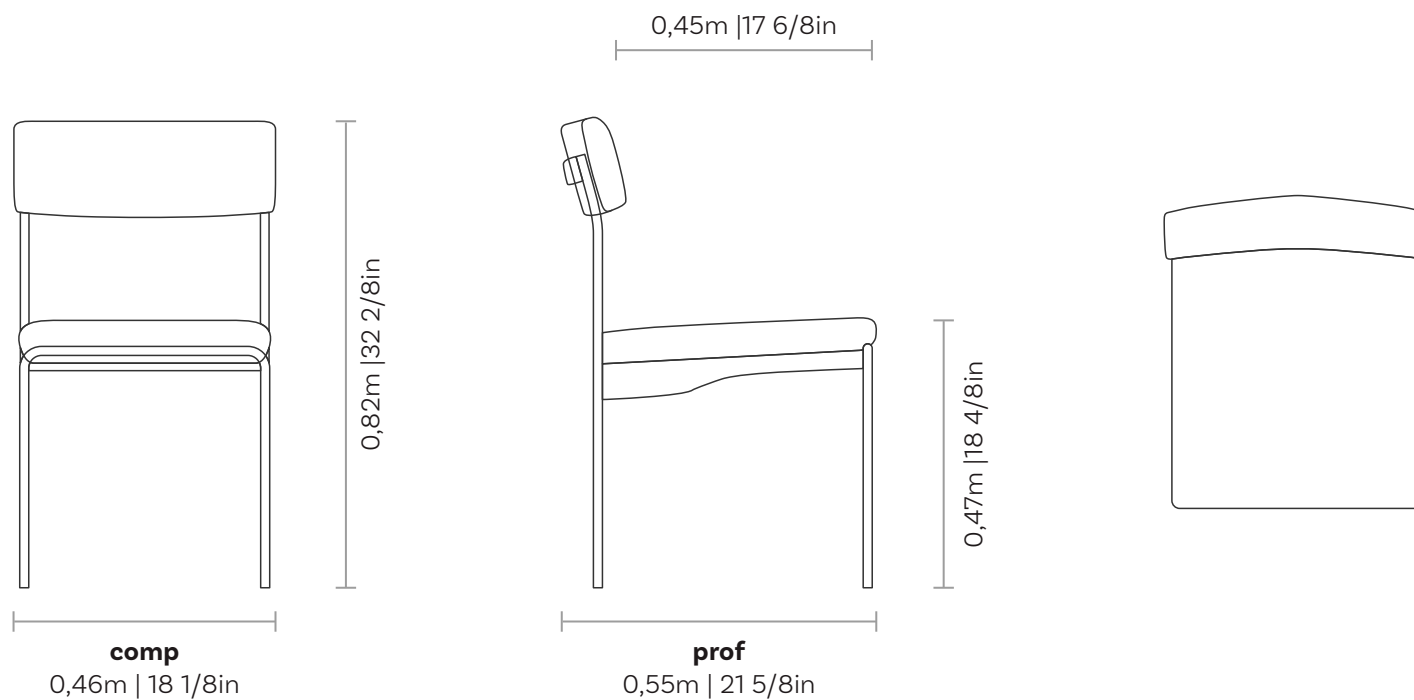

Sillage

CADEIRAS
CHAIRS | SILLAS

Assento: fixo, sem detalhe de costura.

Encosto: fixo, com costura em pesponto pastel.

Base: em aço carbono, disponível nos acabamentos pintura MTX, pintura metalizada e pintura fosca.

Detalhe: em madeira, disponível nos acabamentos verniz, laqueado e laqueado metalizado.

Medidas podem apresentar leves variações. Nos reservamos o direito de efetuar alterações sem consulta prévia.

Base and top: Seat: fixed, without seam detail.

Backrest: fixed, with pastel topstitching.

Base: in carbon steel, available in MTX paint finishes, metallic paint and matte paint.

Detail: in wood, available in varnish, lacquered and metallic lacquered finishes.

Measures may vary slightly. We reserve the right to make changes without prior consultation.

*For more information, see our Comfort Guide.

Asiento: fijo, sin detalle de costura.

Respaldo: fijo, con costuras de pespuntos pastel.

Base: en acero al carbono, disponible en acabados de pintura MTX, pintura metalizada y pintura mate.

Detalle: en madera, disponible en acabados barnizados, lacados y lacados metalizados.

Las medidas pueden variar un poco. Nos reservamos el derecho de realizar cambios sin previa consulta.

*Para más informaciones, consulte nuestro Guía de Confort.



PUFFS E BANCOS

OTTOMANS AND BENCHES | PUFOS Y BANCOS

ponto**vírgula**

Dessau

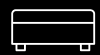

PUFFS
OTTOMANS | PUFFS

ponto**vírgula**



Dessau

PUFFS
OTTOMANS | PUFFS

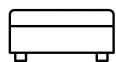

pontovírgula

Dessau

PUFFS
OTTOMANS | PUFFS

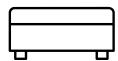
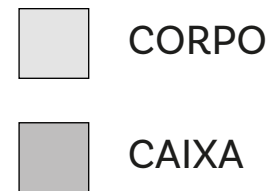
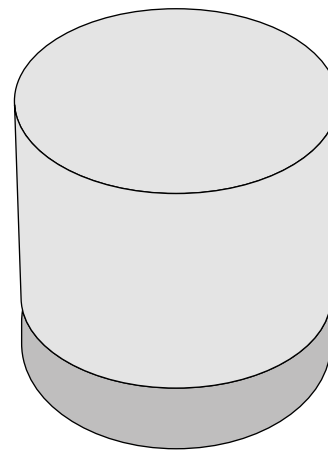
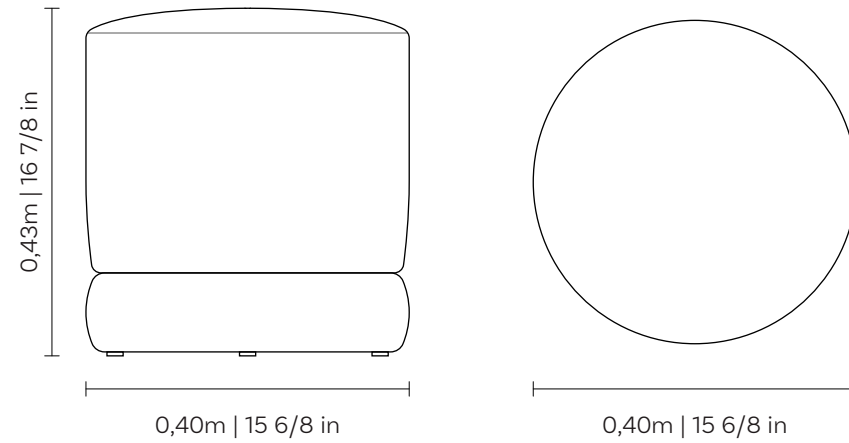

Dessau

PUFFS
OTTOMANS | PUFFS

Assento: Fixo, com costura em pesponto simples.
Suporte: pés niveladores em aço carbono.

Medidas podem apresentar leves variações. Nos reservamos o direito de efetuar alterações sem consulta prévia.

Seat: Fixed, with simple topstitching.
Support: Leveling feet made of carbon steel.

Measures may vary slightly. We reserve the right to make changes without prior consultation.
*For more information, see our Comfort Guide.

Asiento: Fijo, con costura de pespunte simple.
Soporte: Pies niveladores de acero al carbono.

Las medidas pueden variar un poco. Nos reservamos el derecho de realizar cambios sin previa consulta.
*Para más informaciones, consulte nuestro Guía de Confort.

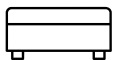

Nuvia



PUFFS
OTTOMANS | PUFFS

pontovirgula



Nuvia

PUFFS
OTTOMANS | PUFFS

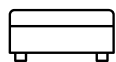

ponto**vírgula**

Nuvia

PUFFS
OTTOMANS | PUFFS

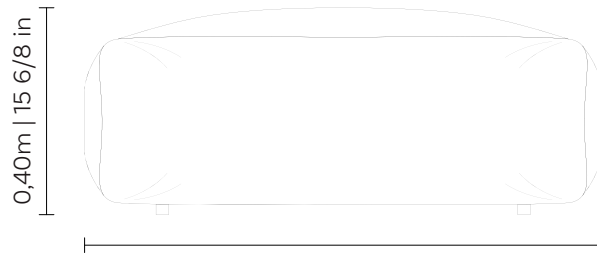

0,60m | 23 5/8 in
0,80 m | 31 4/8 in
1,00 m | 39 3/8 in

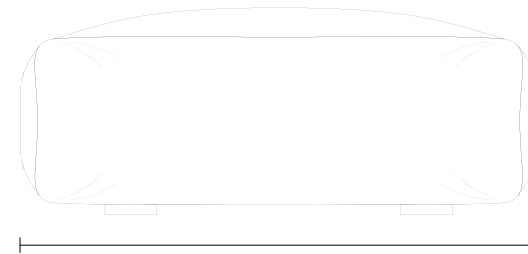

0,60m | 23 5/8 in
0,80 m | 31 4/8 in
1,00 m | 39 3/8 in

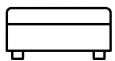
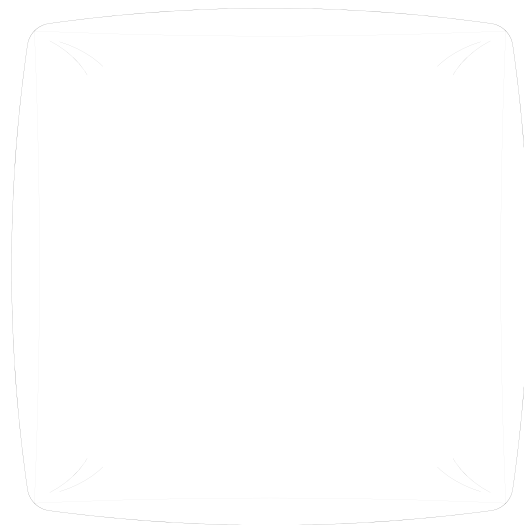

Nuvia

PUFFS
OTTOMANS | PUFFS

Assento: Fixo, sem detalhe de costura e com sobra de tecido.
Suporte: pés em polipropileno injetado na cor preta.

Medidas podem apresentar leves variações. Nos reservamos o direito de efetuar alterações sem consulta prévia.

Seat: Fixed, without stitching details and with extra fabric allowance. Support: Injection-molded polypropylene legs in black.

Measures may vary slightly. We reserve the right to make changes without prior consultation.

Asiento: Fijo, sin detalle de costura y con sobrante de tejido. Soporte: Patas de polipropileno inyectado en color negro.

Las medidas pueden variar un poco. Nos reservamos el derecho de realizar cambios sin previa consulta.

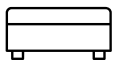

MESAS DE CENTRO E LATERAL

COFFEE AND SIDE TABLES | MESAS DE CENTRO Y AUXILIARES

ponto**vírgula**

Bardot



MESAS
TABLES | MESAS

pontovírgula



Bardot

MESAS
TABLES | MESAS



Bardot

MESAS
TABLES | MESAS

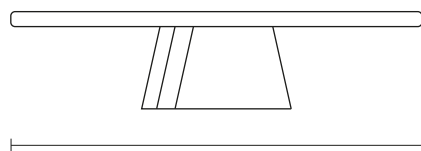
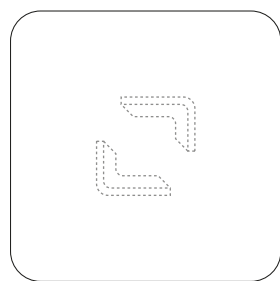

1,10 m | 43 2/8 in

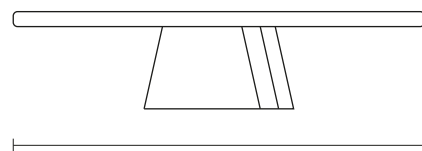

1,10 m | 43 2/8 in

0,26 m | 10 2/8 in

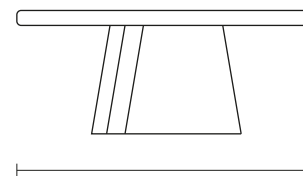
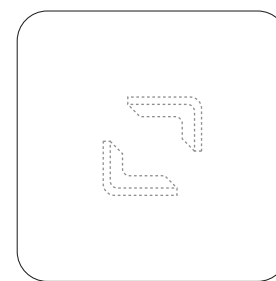

0,80 m | 31 4/8 in
1,00 m | 39 3/8 in
1,10 m | 43 2/8 in

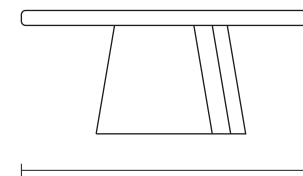

0,80 m | 31 4/8 in
1,00 m | 39 3/8 in
1,10 m | 43 2/8 in

0,33 m | 13 in



Bardot

MESAS
TABLES | MESAS

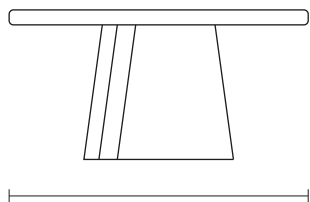

0,80 m | 31 4/8 in
1,00 m | 39 3/8 in

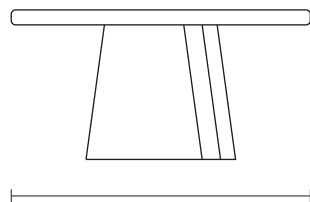

0,80 m | 31 4/8 in
1,00 m | 39 3/8 in

0,40 m | 15 6/8 in

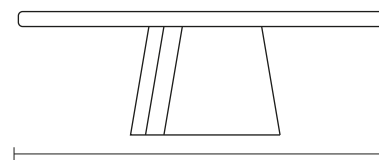
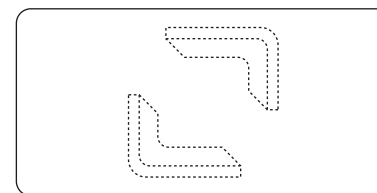

1,00 m | 39 3/8 in

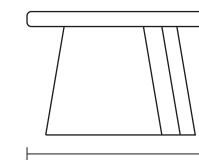

0,50 m | 19 5/8 in

0,33 m | 13 in
0,40 m | 15 6/8 in



Bardot

MESAS
TABLES | MESAS

DESIGN PADRÃO

STANDARD DESIGN | DISEÑO ESTÁNDAR

BORDAS INFERIORES

UNDERTOP BORDERS | BORDES INFERIORES



BOLD



SMOOTH R50 INVERTED

BORDAS DE PEDRA

STONE BORDERS | BORDES DE PIEDRA



DEMI BULLNOSE

Acabamentos do tampo:

Laminado, laminado especial e laminado laqueado, laca, recouro.

Acabamentos da base:

Laminado, laminado especial e laminado laqueado, laca, recouro.

Medidas podem apresentar leves variações. Nos reservamos o direito de efetuar alterações sem consulta prévia.

Top finishes:

Laminate, special laminate and lacquered laminate , lacquer, reconstituted leather.

Bases finishes:

Laminate, special laminate and lacquered laminate, lacquer, reconstituted leather.

Measures may vary slightly. We reserve the right to make changes without prior consultation.

Acabados de la tapa:

Laminado, laminado especial y laminado lacado, laca, cuero reconstituido.

Acabados de las bases:

Laminado, laminado especial y laminado lacado, laca, cuero reconstituido.

Las medidas pueden variar un poco. Nos reservamos el derecho de realizar cambios sin previa consulta.



ponto**vírgula**

Brick



MESAS DE CENTRO E LATERAL
COFFEE AND SIDE TABLES | MESAS DE CENTRO Y AUXILIARES

pontovírgula



Brick

MESAS DE CENTRO E LATERAL
COFFEE AND SIDE TABLES | MESAS DE CENTRO Y AUXILIARES

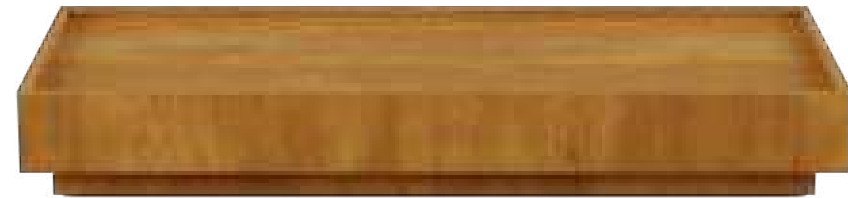

Brick

MESAS DE CENTRO E LATERAL
COFFEE AND SIDE TABLES | MESAS DE CENTRO Y AUXILIARES

MESA LATERAL

SIDE TABLE | MESA DE ARRIMO

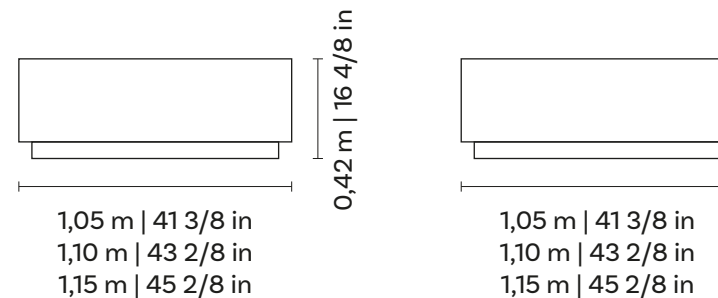
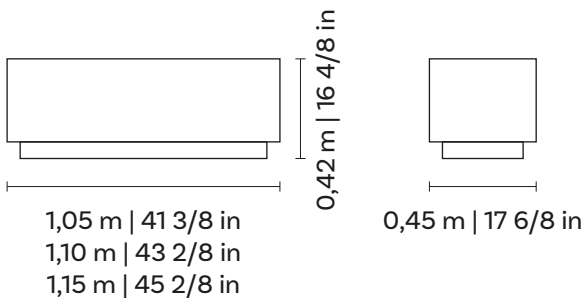
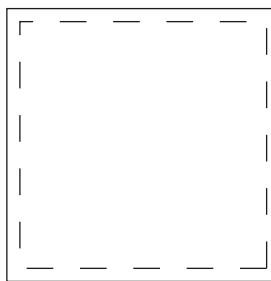
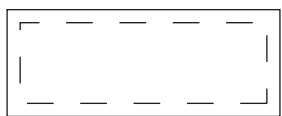

Brick

MESAS DE CENTRO E LATERAL
COFFEE AND SIDE TABLES | MESAS DE CENTRO Y AUXILIARES

MESA DE CENTRO

COFFEE TABLE | MESA DE CENTRO

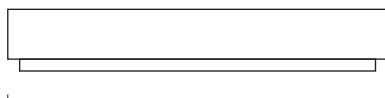

1,60 m | 63 in
1,80 m | 70 7/8 in

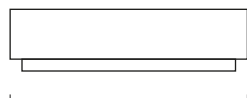

1,00 m | 39 3/8 in
0,80 m | 31 4/8 in

0,26 m | 10 2/8 in

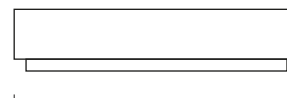
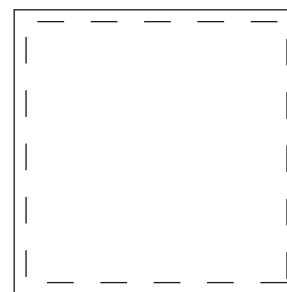

0,90 m | 35 3/8 in
1,00 m | 39 3/8 in
1,20 m | 47 2/8 in

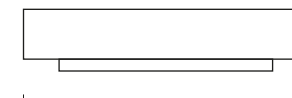

0,90 m | 35 3/8 in
1,00 m | 39 3/8 in
1,20 m | 47 2/8 in

0,26 m | 10 2/8 in



Brick

MESAS DE CENTRO E LATERAL
COFFEE AND SIDE TABLES | MESAS DE CENTRO Y AUXILIARES

DESIGN PADRÃO

STANDARD DESIGN | DISEÑO ESTÁNDAR

BORDAS DE PEDRA

STONE BORDERS | BORDES DE PIEDRA



RETO
STRAIGHT
RETO

Acabamentos do tampo:

Laminado, laminado especial e laminado laqueado, laca, vidro pintado/fosco, espelho, mármore e mármore levigado.

Acabamentos da base:

Laminado, laminado especial e laminado laqueado, laca, recouro.

Medidas podem apresentar leves variações. Nos reservamos o direito de efetuar alterações sem consulta prévia.

Top finishes:

Laminate, special laminate and lacquered laminate, lacquer, painted/frosted glass, mirror, marble and honed marble.

Bases finishes:

Laminate, special laminate and lacquered laminate, lacquer, reconstituted leather.

Measures may vary slightly. We reserve the right to make changes without prior consultation.

Acabados de la tapa:

Laminado, laminado especial y laminado lacado, laca, vidrio pintado/escarchado, espejo, mármol y mármol alisado.

Acabados de las bases:

Laminado, laminado especial y laminado lacado, laca, cuero reconstituido.

Las medidas pueden variar un poco. Nos reservamos el derecho de realizar cambios sin previa consulta.



ponto**vírgula**

Calyx



MESAS DE CENTRO E LATERAL
COFFEE AND SIDE TABLES | MESAS DE CENTRO Y AUXILIARES

pontovírgula



Calyx

MESAS DE CENTRO E LATERAL
COFFEE AND SIDE TABLES | MESAS DE CENTRO Y AUXILIARES



Calyx

MESAS DE CENTRO E LATERAL
COFFEE AND SIDE TABLES | MESAS DE CENTRO Y AUXILIARES

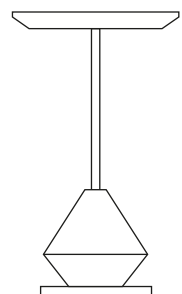
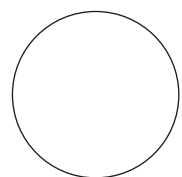

0,30 m | 11 6/8 in

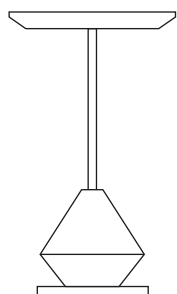

0,30 m | 11 6/8 in

0,51 m | 20 1/8 in

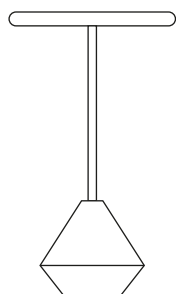
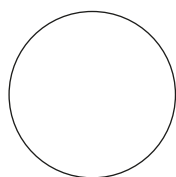

0,30 m | 11 6/8 in

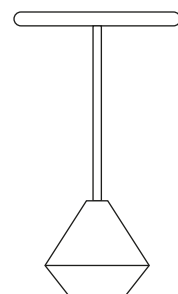

0,30 m | 11 6/8 in

0,53 m | 20 7/8 in

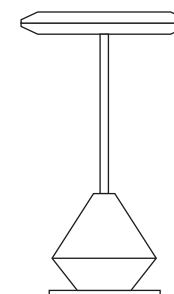
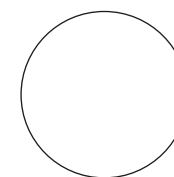

0,30 m | 11 6/8 in

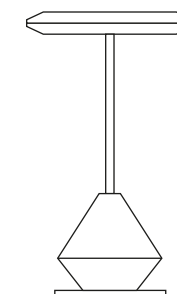

0,30 m | 11 6/8 in

0,51 m | 20 1/8 in



DESIGN PADRÃO

STANDARD DESIGN | DISEÑO ESTÁNDAR

BORDAS INFERIORES

UNDERTOP BORDERS | BORDES INFERIORES



CHAMFER 60°
CHANFRO 60°
CHAFLÁN 60°



DOIS CHAMFROS LATERAIS
TWO SIDE CHAMFERS
DOS CHAFLANES LATERALES

BORDAS DE PEDRA

STONE BORDERS | BORDES DE PIEDRA



FULL BULLNOSE

Acabamentos do tampo:

Laminado, laminado especial e laminado laqueado,
laca, vidro pintado/fosco, espelho, mármore,
mármore levigado e recouro.

Acabamentos da base:

Laminado, laminado especial e laminado laqueado, laca.

Medidas podem apresentar leves variações. Nos reservamos o direito de efetuar alterações sem consulta prévia.

Top finishes:

Laminate, special laminate and lacquered laminate,
lacquer, painted/frosted glass, mirror, marble, honed
marble and reconstituted leather.

Bases finishes:

Laminate, special laminate and lacquered laminate, lacquer.

Measures may vary slightly. We reserve the right to make changes without prior consultation.

Acabados de la tapa:

Laminado, laminado especial y laminado lacado, laca,
vidrio pintado/escarchado, espejo, mármol, mármol alisado,
cuero reconstituido.

Acabados de las bases:

Laminado, laminado especial y laminado lacado, laca.

Las medidas pueden variar un poco. Nos reservamos el derecho de realizar cambios sin previa consulta.



Colonna



MESAS DE CENTRO E LATERAL
COFFEE AND SIDE TABLES | MESAS DE CENTRO Y AUXILIARES

pontovírgula



Colonna

MESAS DE CENTRO E LATERAL
FFEE AND SIDE TABLES | MESAS DE CENTRO Y AUXILIARES



Colonna

MESAS DE CENTRO E LATERAL
COFFEE AND SIDE TABLES | MESAS DE CENTRO Y AUXILIARES

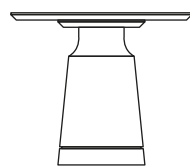
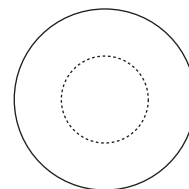
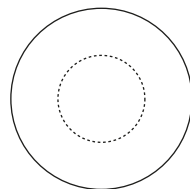

0,60m | 19 5/8 in

0,42m | 16 4/8 in

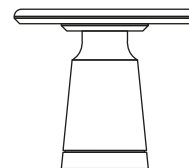

0,60m | 19 5/8 in

0,42m | 16 4/8 in

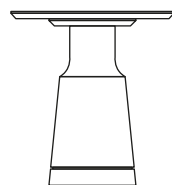
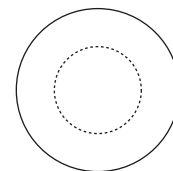
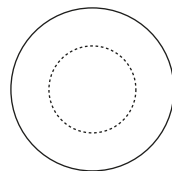

0,45m | 17 6/8 in

0,48m | 18 7/8 in

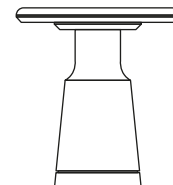

0,45m | 17 6/8 in

0,48m | 18 7/8 in



Colonna

MESAS DE CENTRO E LATERAL
COFFEE AND SIDE TABLES | MESAS DE CENTRO Y AUXILIARES

DESIGN PADRÃO

STANDARD DESIGN | DISEÑO ESTÁNDAR

BORDAS DE PEDRA
STONE BORDERS | BORDES DE PIEDRA



RETO
STRAIGHT
RETO

Acabamentos do tampo:

Laminado, laminado especial e laminado laqueado,
laca, vidro pintado/fosco, espelho, mármore, mármore levigado.

Acabamentos da base:

Laminado, laminado especial e laminado laqueado, laca.

Medidas podem apresentar leves variações. Nos reservamos o direito de efetuar alterações sem consulta prévia.

Top finishes:

Laminate, special laminate and lacquered laminate,
lacquer, painted/frosted glass, mirror, marble, honed marble.

Bases finishes:

Laminate, special laminate and lacquered laminate, lacquer.

Measures may vary slightly. We reserve the right to make changes without prior consultation.

Acabados de la tapa:

Laminado, laminado especial y laminado lacado, laca,
vidrio pintado/escarchado, espejo, mármol, mármol alisado.

Acabados de las bases:

Laminado, laminado especial y laminado lacado, laca.

Las medidas pueden variar un poco. Nos reservamos el derecho de realizar cambios sin previa consulta.



Dune



MESAS DE CENTRO E LATERAL
COFFEE AND SIDE TABLES | MESAS DE CENTRO Y AUXILIARES

pontovírgula



Dune

MESAS DE CENTRO E LATERAL
COFFEE AND SIDE TABLES | MESAS DE CENTRO Y AUXILIARES



Dune

MESAS DE CENTRO E LATERAL
COFFEE AND SIDE TABLES | MESAS DE CENTRO Y AUXILIARES

MESA DE CENTRO

COFFEE TABLE | MESA DE CENTRO

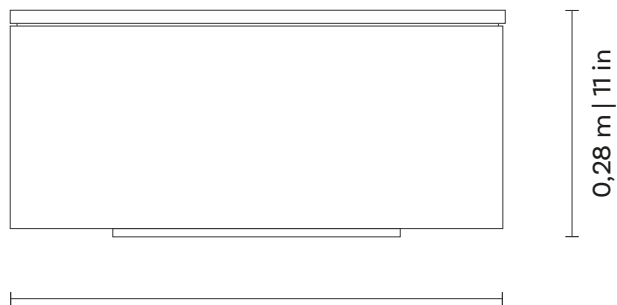

0,90 m | 35 3/8 in
1,00 m | 39 3/8 in
1,10 m | 43 2/8 in
1,20 m | 47 2/8 in

MESA LATERAL

SIDE TABLE | MESA DE ARRIMO

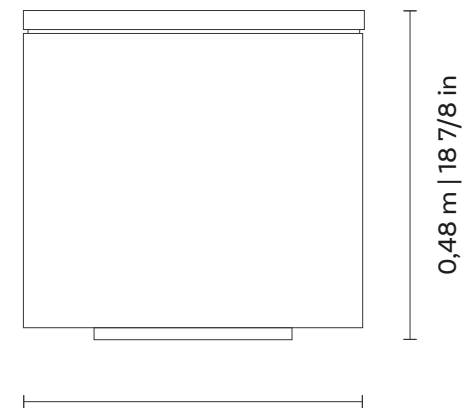

0,50 m | 19 5/8 in



Dune

MESAS DE CENTRO E LATERAL
COFFEE AND SIDE TABLES | MESAS DE CENTRO Y AUXILIARES

Base com estrutura em MDF disponível nos acabamentos laminado, pintura verniz e pintura laca. Bandeja com estrutura em MDF disponível nos acabamentos Laminado, pintura Verniz e pintura laca. Tampo com opção em mármore, espelho ou vidro pintado no acabamento laca.

Medidas podem apresentar leves variações. Nos reservamos o direito de efetuar alterações sem consulta prévia.

Base with structure in MDF available in Laminate, varnish painting and lacquer painting finishes. Tray with structure in MDF available in laminate, varnish and Lacquer finishes. Top with option in marble, mirror or painted glass in Lacquer finish

Measures may vary slightly. We reserve the right to make changes without prior consultation.

Base con estructura en MDF disponible en acabados laminado, pintura barniz y pintura Laca. bandeja con estructura en MDF disponible en acabados laminado, barniz y lacado. Tapa con opción en mármol, espejo o cristal pintado en acabado laca.

Las medidas pueden variar un poco. Nos reservamos el derecho de realizar cambios sin previa consulta.



Eclipse



MESAS DE CENTRO E LATERAL
COFFEE AND SIDE TABLES | MESAS DE CENTRO Y AUXILIARES

pontovírgula



Eclipse

MESAS DE CENTRO E LATERAL
COFFEE AND SIDE TABLES | MESAS DE CENTRO Y AUXILIARES



Eclipse

MESAS DE CENTRO E LATERAL
COFFEE AND SIDE TABLES | MESAS DE CENTRO Y AUXILIARES

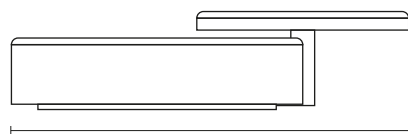
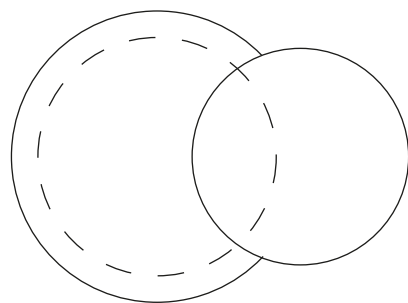

1,25 m | 49 2/8 in
1,50 m | 59 in
1,60 m | 63 in

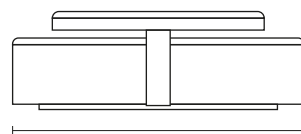

0,90 m | 35 3/8 in
1,10 m | 43 2/8 in
1,20 m | 47 2/8 in

0,35 m | 13 6/8 in

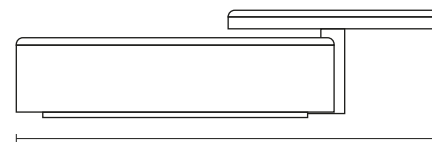
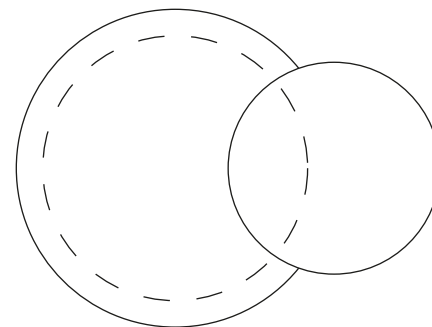

1,50 m | 59 in
1,60 m | 63 in

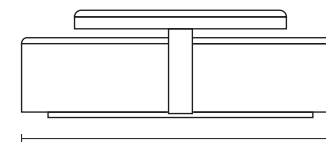

1,10 m | 43 2/8 in
1,20 m | 47 2/8 in

0,37 m | 14 5/8 in



Eclipse

MESAS DE CENTRO E LATERAL
COFFEE AND SIDE TABLES | MESAS DE CENTRO Y AUXILIARES

DESIGN PADRÃO

STANDARD DESIGN | DISEÑO ESTÁNDAR

BORDAS DE PEDRA

STONE BORDERS | BORDES DE PIEDRA



RETO
STRAIGHT
RETO

Acabamentos do tampo:

Laminado, laminado especial e laminado laqueado, laca, vidro pintado/fosco, espelho, mármore e mármore levigado.

Acabamentos da base:

Laminado, laminado especial e laminado laqueado, laca, recouro.

Medidas podem apresentar leves variações. Nos reservamos o direito de efetuar alterações sem consulta prévia.

Top finishes:

Laminate, special laminate and lacquered laminate, lacquer, painted/frosted glass, mirror, marble and honed marble.

Bases finishes:

Laminate, special laminate and lacquered laminate lacquer, reconstituted leather.

Measures may vary slightly. We reserve the right to make changes without prior consultation.

Acabados de la tapa:

Laminado, laminado especial y laminado lacado, laca, vidrio pintado/escarchado, espejo, mármol y mármol alisado.

Acabados de las bases:

Laminado, laminado especial y laminado lacado, laca, cuero reconstituido.

Las medidas pueden variar un poco. Nos reservamos el derecho de realizar cambios sin previa consulta.



ponto**vírgula**

Lizza



MESAS
TABLES | MESAS

ponto**vírgula**



Lizza

MESAS
TABLES | MESAS



pontovírgula

Lizza

MESAS
TABLES | MESAS

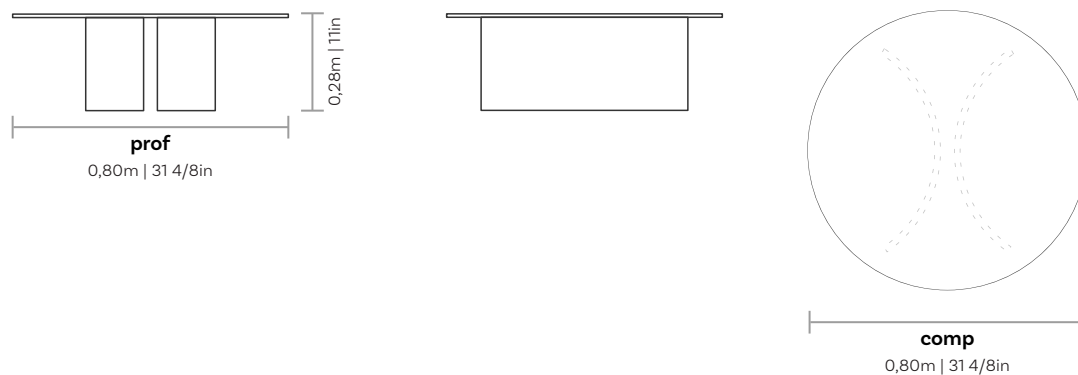
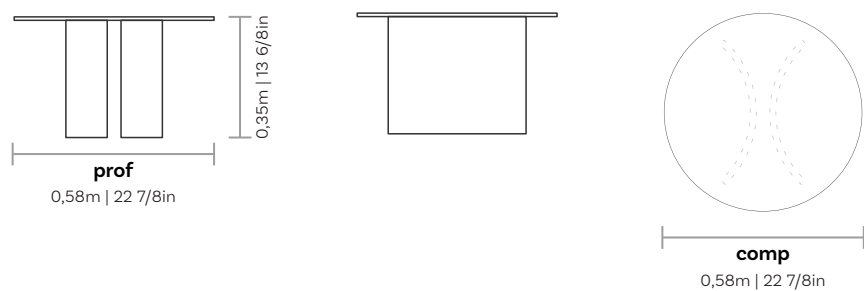
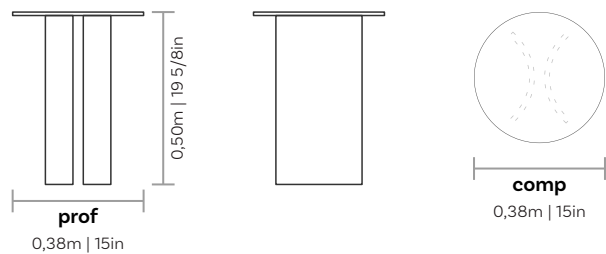

Lizza

MESAS
TABLES | MESAS

Base e tampo: em aço carbono, disponível nos acabamentos pintura MTX, pintura metalizada e pintura fosca.

Medidas podem apresentar leves variações. Nos reservamos o direito de efetuar alterações sem consulta prévia.

Base and top: in carbon steel, available in MTX paint, metallic paint and matte paint finishes.

Measures may vary slightly. We reserve the right to make changes without prior consultation.
*For more information, see our Comfort Guide.

Base y tope: en acero al carbono, disponible en acabados pintura MTX, pintura metalizada y pintura mate.

Las medidas pueden variar un poco. Nos reservamos el derecho de realizar cambios sin previa consulta.
*Para más informaciones, consulte nuestro Guía de Confort.



Louise



MESAS DE CENTRO E LATERAL
COFFEE AND SIDE TABLES | MESAS DE CENTRO Y AUXILIARES

pontovírgula



Louise

MESAS DE CENTRO E LATERAL
COFFEE AND SIDE TABLES | MESAS DE CENTRO Y AUXILIARES



Louise

MESAS DE CENTRO E LATERAL
COFFEE AND SIDE TABLES | MESAS DE CENTRO Y AUXILIARES

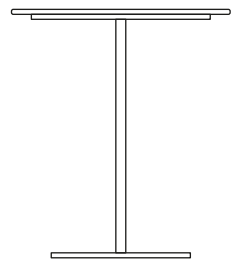
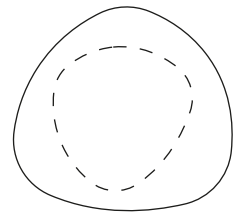

0,44 m | 17 3/8 in

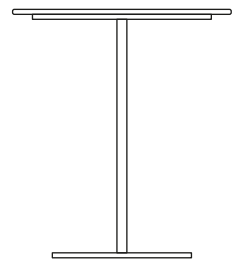

0,41 m | 16 1/8 in

0,50 m | 19 5/8 in

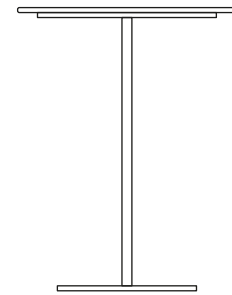
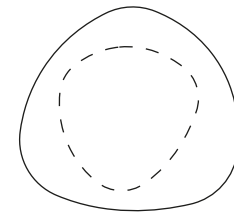

0,44 m | 17 3/8 in

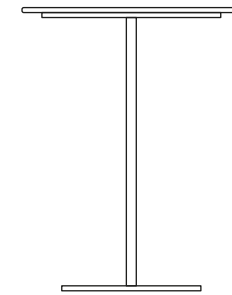

0,41 m | 16 1/8 in

0,57 m | 22 4/8 in



Louise

MESAS DE CENTRO E LATERAL
COFFEE AND SIDE TABLES | MESAS DE CENTRO Y AUXILIARES

DESIGN PADRÃO

STANDART DESIGN | DISEÑO ESTÁNDAR

BORDAS INFERIORES

UNDERTOP BORDERS | BORDES INFERIORES



RETO - EM METAL
STRAIGHT - IN METAL
RETO - EN METAL

BORDAS DE PEDRA

STONE BORDERS | BORDES DE PIEDRA



FULL BULLNOSE

Acabamentos do tampo:
Mármore e mármore levigado.

Acabamentos da base:
Laca.

**Medidas podem apresentar leves variações.
Nos reservamos o direito de efetuar alterações sem consulta prévia.**

Top finishes:
Marble and honed marble.

Bases finishes:
Lacquer.

Measures may vary slightly.
We reserve the right to make changes without prior consultation.

Acabados de la tapa:
Mármol y mármol alisado.

Acabados de las bases:
Laca.

Las medidas pueden variar un poco.
Nos reservamos el derecho de realizar cambios sin previa consulta.



Monolith



MESAS DE CENTRO E LATERAL
COFFEE AND SIDE TABLES | MESAS DE CENTRO Y AUXILIARES

pontovírgula



Monolith

MESAS DE CENTRO E LATERAL
COFFEE AND SIDE TABLES | MESAS DE CENTRO Y AUXILIARES

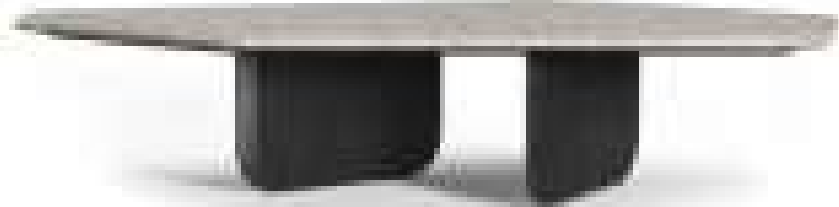

Monolith

MESAS DE CENTRO E LATERAL
COFFEE AND SIDE TABLES | MESAS DE CENTRO Y AUXILIARES

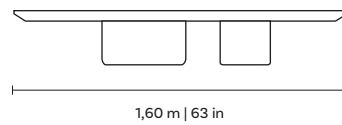
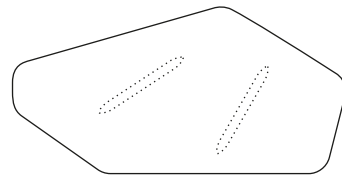

1,60 m | 63 in

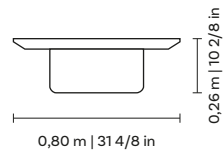

0,80 m | 31 4/8 in

0,26 m | 10 2/8 in

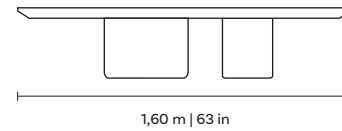
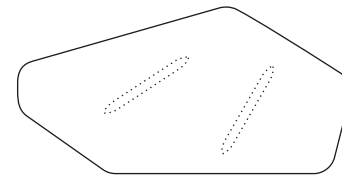

1,60 m | 63 in

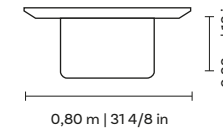

0,80 m | 31 4/8 in

0,33 m | 13 in

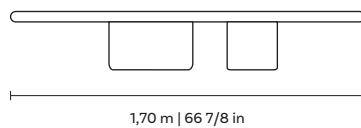
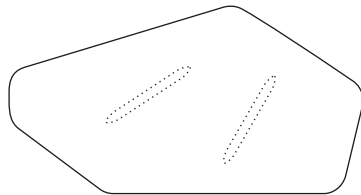

1,70 m | 66 7/8 in

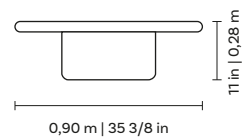

0,90 m | 35 3/8 in

11 in | 0,28 m

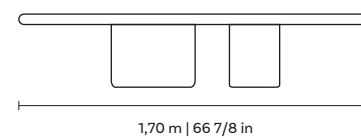
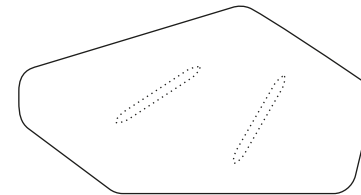

1,70 m | 66 7/8 in

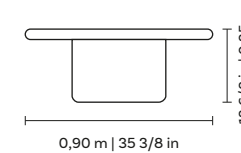

0,90 m | 35 3/8 in

13 6/8 in | 0,35 m



Monolith

MESAS DE CENTRO E LATERAL
COFFEE AND SIDE TABLES | MESAS DE CENTRO Y AUXILIARES

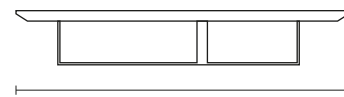
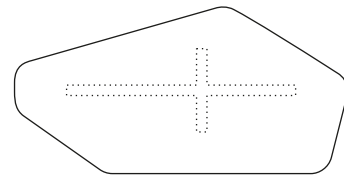

1,60 m | 63 in

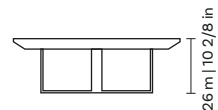

0,80 m | 31 4/8 in

0,26 m | 10 2/8 in

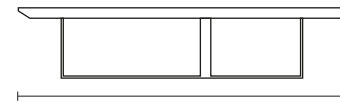
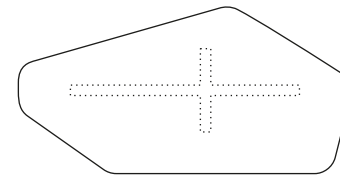

1,60 m | 63 in

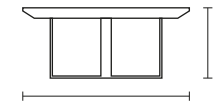

0,80 m | 31 4/8 in

0,33 m | 13 in

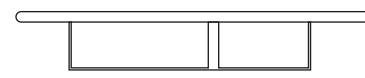
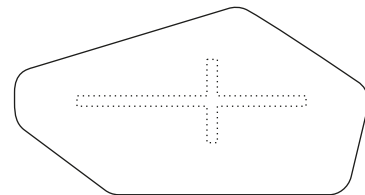

1,70 m | 66 7/8 in

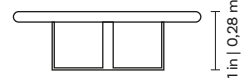

0,90 m | 35 3/8 in

11 in | 0,28 m

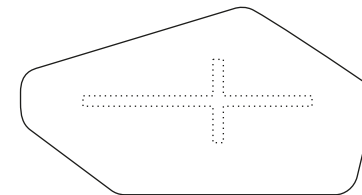

1,70 m | 66 7/8 in

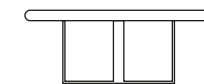

0,90 m | 35 3/8 in

13 6/8 in | 0,35 m



Monolith

MESAS DE CENTRO E LATERAL
COFFEE AND SIDE TABLES | MESAS DE CENTRO Y AUXILIARES

DESIGN PADRÃO

STANDARD DESIGN | DISEÑO ESTÁNDAR

FORMATOS DO TAMPO

TOP SHAPES | FORMAS SUPERIORES



BORDAS INFERIORES

UNDERTOP BORDERS | BORDES INFERIORES



CHANFRO 60°
CHAMFER 60°

BORDAS DE PEDRA

STONE BORDERS | BORDES DE PIEDRA



FULL BULLNOSE

Acabamentos do tampo:

Laminado, laminado especial e laminado laqueado, laca, vidro pintado/fosco, espelho, mármore e mármore levigado.

Acabamentos da base:

Laminado, laminado especial e laminado laqueado, laca, recouro.

Top finishes:

Laminate, special laminate and lacquered laminate, lacquer, painted/frosted glass, mirror, marble and honed marble.

Bases finishes:

Laminate, special laminate and lacquered laminate lacquer, reconstituted leather.

Measures may vary slightly. We reserve the right to make changes without prior consultation.

Acabados de la tapa:

Laminado, laminado especial y laminado lacado, laca, vidrio pintado/escarchado, espejo, mármol y mármol alisado.

Acabados de las bases:

Laminado, laminado especial y laminado lacado, laca, cuero reconstituido.

Las medidas pueden variar un poco. Nos reservamos el derecho de realizar cambios sin previa consulta.



Orbit



MESAS
TABLES | MESAS

pontovírgula



Orbit

MESAS
TABLES | MESAS



Orbit

MESAS
TABLES | MESAS

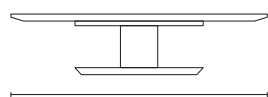

0,90 m | 35 3/8 in
1,00 | 39 3/8 in
1,10 m | 43 2/8 in

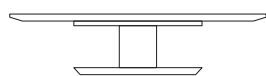

0,26 m | 10 2/8 in

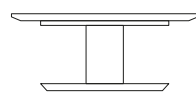

0,80 m | 31 4/8 in
0,90 m | 35 3/8 in
1,00 | 39 3/8 in
1,10 m | 43 2/8 in

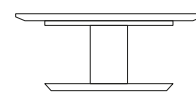

0,33 m | 13 in

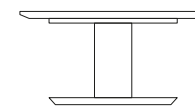

0,60 m | 23 5/8 in
0,80 m | 31 4/8 in
0,90 m | 35 3/8 in

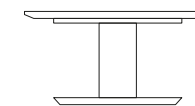

0,40 m | 15 6/8 in

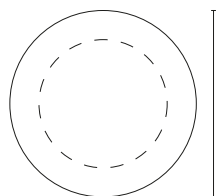

0,90 m | 35 3/8 in
1,00 | 39 3/8 in
1,10 m | 43 2/8 in

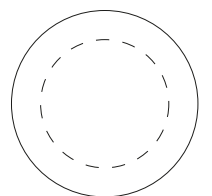

0,80 m | 31 4/8 in
0,90 m | 35 3/8 in
1,00 | 39 3/8 in
1,10 m | 43 2/8 in

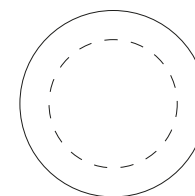

0,60 m | 23 5/8 in
0,80 m | 31 4/8 in
0,90 m | 35 3/8 in



Orbit

MESAS
TABLES | MESAS

DESIGN PADRÃO

STANDARD DESIGN | DISEÑO ESTÁNDAR

BORDAS INFERIORES

UNDERTOP BORDERS | BORDES INFERIORES



CHANFRO 60°
CHAMFER 60°
CHAFLÁN 60°

BORDAS DE PEDRA

STONE BORDERS | BORDES DE PIEDRA



DEMI BULLNOSE

Acabamentos do tampo:

Laminado, laminado especial e laminado laqueado, laca, vidro pintado/fosco, espelho, mármore e mármore levigado.

Acabamentos da base:

Laminado, laminado especial e laminado laqueado, laca.

Medidas podem apresentar leves variações. Nos reservamos o direito de efetuar alterações sem consulta prévia.

Top finishes:

Laminate, special laminate and lacquered laminate, lacquer, painted/frosted glass, mirror, marble and honed marble.

Bases finishes:

Laminate, special laminate and lacquered laminate, lacquer.

Measures may vary slightly. We reserve the right to make changes without prior consultation.

Acabados de la tapa:

Laminado, laminado especial y laminado lacado, laca, vidrio pintado/escarchado, espejo, mármol y mármol alisado.

Acabados de las bases:

Laminado, laminado especial y laminado lacado, laca.

Las medidas pueden variar un poco. Nos reservamos el derecho de realizar cambios sin previa consulta.



ponto**vírgula**

Pierre



MESAS DE CENTRO E LATERAL
COFFEE AND SIDE TABLES | MESAS DE CENTRO Y AUXILIARES

pontovírgula



Pierre

MESAS DE CENTRO E LATERAL
COFFEE AND SIDE TABLES | MESAS DE CENTRO Y AUXILIARES



Pierre

MESAS DE CENTRO E LATERAL
COFFEE AND SIDE TABLES | MESAS DE CENTRO Y AUXILIARES

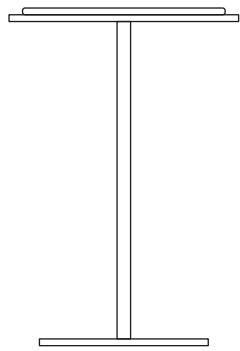
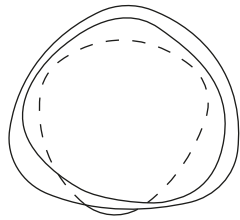

0,34m | 13 3/8 in

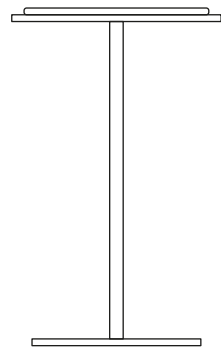

0,31m | 12 2/8 in

0,50m | 19 5/8 in

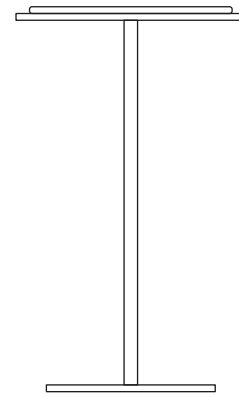
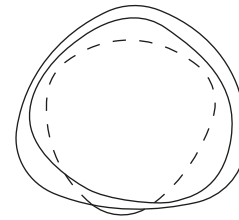

0,34m | 13 3/8 in

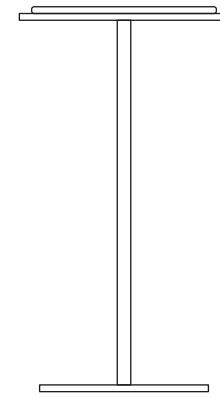

0,31m | 12 2/8 in

0,57m | 22 4/8 in



Pierre

MESAS DE CENTRO E LATERAL
COFFEE AND SIDE TABLES | MESAS DE CENTRO Y AUXILIARES

DESIGN PADRÃO

STANDARD DESIGN | DISEÑO ESTÁNDAR

BORDAS INFERIORES

UNDERTOP BORDERS | BORDES INFERIORES



STRAIGHT - IN METAL
RETO - EM METAL
RETO - EN METAL

BORDAS DE PEDRA

STONE BORDERS | BORDES DE PIEDRA



DEMI BULLNOSE

Acabamentos do tampo:
Laca com mármore ou mármore levigado.

Acabamentos da base:
Laca.

Measures may vary slightly.

We reserve the right to make changes without prior consultation.

Top finishes:
Lacquer with marble or honed marble.

Bases finishes:
Lacquer.

Measures may vary slightly.

We reserve the right to make changes without prior consultation.

Acabados de la tapa:
Laca y mármol o mármol alisado.

Acabados de las bases:
Laca.

Las medidas pueden variar un poco.

Nos reservamos el derecho de realizar cambios sin previa consulta.



Polara



MESAS
TABLES | MESAS

ponto**vírgula**



Polara

MESAS
TABLES | MESAS



pontovírgula

Polara

MESAS
TABLES | MESAS

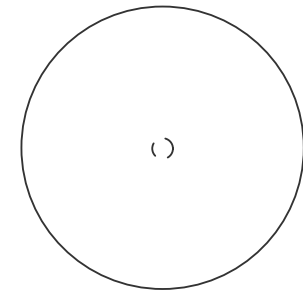
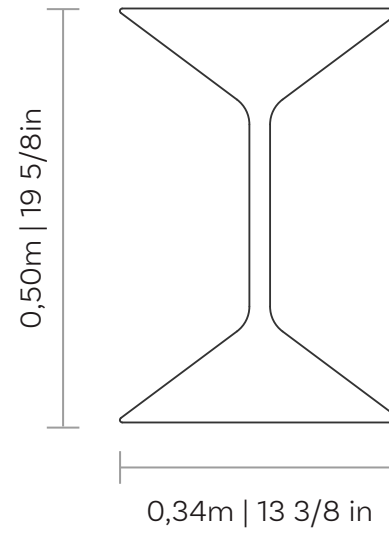
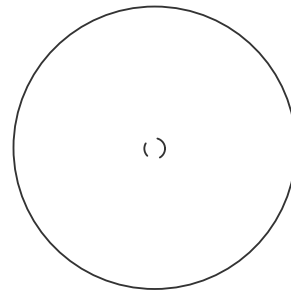
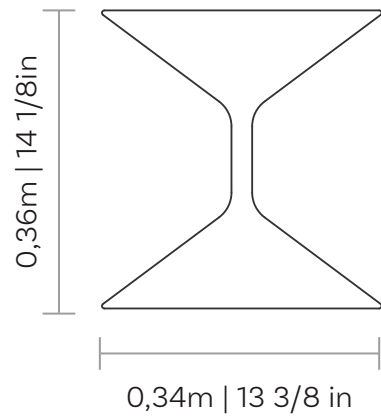

Polara

MESAS
TABLES | MESAS

Mesa com base em fibra de vidro disponível nos acabamentos pintura laca e laca metalizado.

Medidas podem apresentar leves variações. Nos reservamos o direito de efetuar alterações sem consulta prévia.

Table with fiberglass base available in lacquer paint and metallic lacquer finishes.

Measures may vary slightly. We reserve the right to make changes without prior consultation.
*For more information, see our Comfort Guide.

Mesa con base de fibra de vidrio disponible en acabados lacados, pintura y laca metalizada.

Las medidas pueden variar un poco. Nos reservamos el derecho de realizar cambios sin previa consulta.
*Para más informaciones, consulte nuestro Guía de Confort.



Venturi



MESAS DE CENTRO E LATERAL
COFFEE AND SIDE TABLES | MESAS DE CENTRO Y AUXILIARES

pontovírgula



Venturi

MESAS DE CENTRO E LATERAL
COFFEE AND SIDE TABLES | MESAS DE CENTRO Y AUXILIARES



ponto**vírgula**

Venturi

MESAS DE CENTRO E LATERAL
COFFEE AND SIDE TABLES | MESAS DE CENTRO Y AUXILIARES

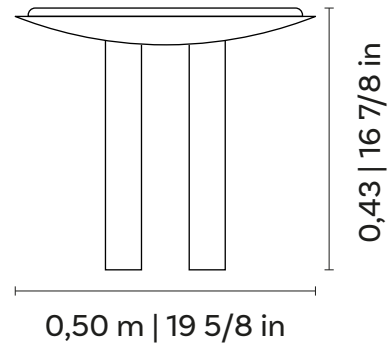
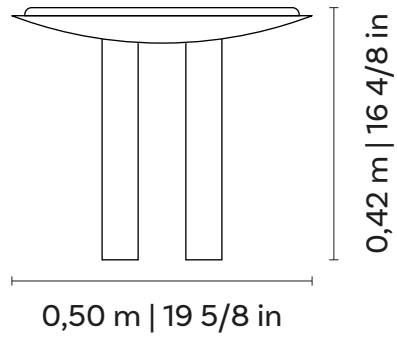
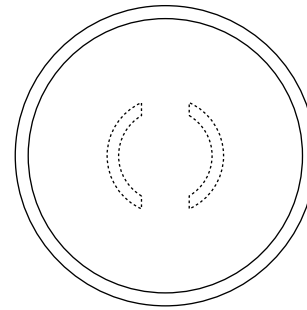
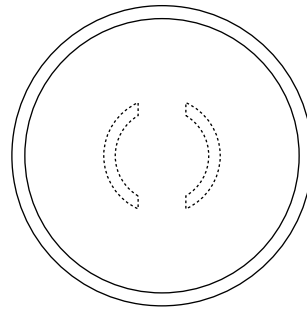

Venturi

MESAS DE CENTRO E LATERAL
COFFEE AND SIDE TABLES | MESAS DE CENTRO Y AUXILIARES

DESIGN PADRÃO

STANDARD DESIGN | DISEÑO ESTÁNDAR

BORDAS DE PEDRA

STONE BORDERS | BORDES DE PIEDRA



DEMI BULLNOSE

Acabamentos do tampo:

Laminado, laminado especial e laminado laqueado, laca, vidro pintado/fosco, espelho, mármore e mármore levigado.

Acabamentos da base:

Laminado, laminado especial e laminado laqueado, laca, recouro.

Medidas podem apresentar leves variações. Nos reservamos o direito de efetuar alterações sem consulta prévia.

Top finishes:

Laminate, special laminate and lacquered laminate, lacquer, painted/frosted glass, mirror, marble and honed marble.

Bases finishes:

Laminate, special laminate and lacquered laminate lacquer, reconstituted leather.

Measures may vary slightly. We reserve the right to make changes without prior consultation.

Acabados de la tapa:

Laminado, laminado especial y laminado lacado, laca, vidrio pintado/escarchado, espejo, mármol y mármol alisado.

Acabados de las bases:

Laminado, laminado especial y laminado lacado, laca, cuero reconstituído.

Las medidas pueden variar un poco. Nos reservamos el derecho de realizar cambios sin previa consulta.



MESAS DE CABECEIRA

BEDSIDE TABLES | MESAS DE CABECERA

ponto**vírgula**

Halo



MESAS DE CABECEIRA
BEDSIDE TABLES | MESAS DE CABECEIRA

pontovírgula



Halo

MESAS DE CABECEIRA
BEDSIDE TABLES | MESAS DE CABECEIRA



Halo

MESAS DE CABECEIRA
BEDSIDE TABLES | MESAS DE CABECEIRA

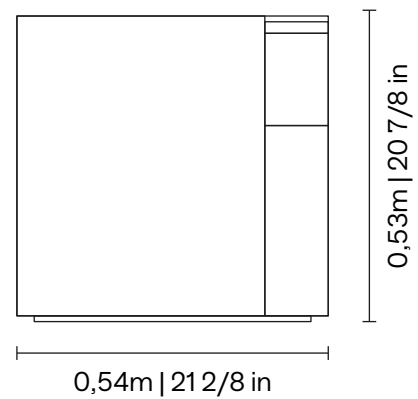
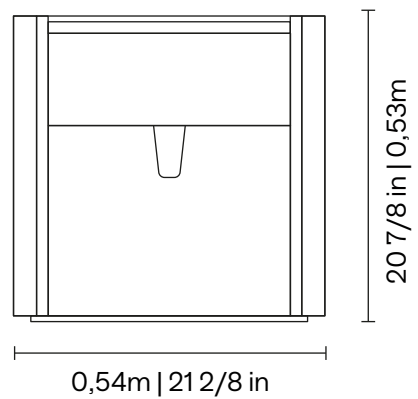
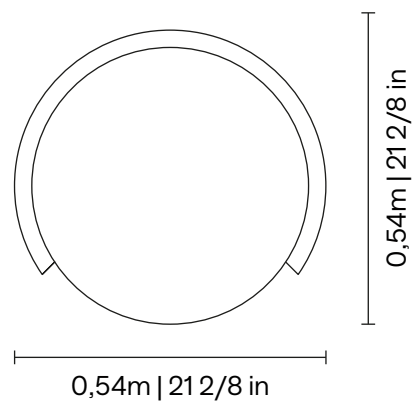

Halo

MESAS DE CABECEIRA
BEDSIDE TABLES | MESAS DE CABECEIRA

DESIGN PADRÃO

STANDARD DESIGN | DISEÑO ESTÁNDAR

BORDAS DE PEDRA

STONE BORDERS | BORDES DE PIEDRA



RETO
STRAIGHT
RETO

Acabamentos do tampo:

Laminado, laminado especial e laminado laqueado, laca, vidro pintado/fosco, espelho, mármore e mármore levigado.

Acabamentos da base:

Laminado, laminado especial e laminado laqueado, laca, recouro.

Medidas podem apresentar leves variações. Nos reservamos o direito de efetuar alterações sem consulta prévia.

Top finishes:

Laminate, special laminate and lacquered laminate, lacquer, painted/frosted glass, mirror, marble and honed marble.

Bases finishes:

Laminate, special laminate and lacquered laminate lacquer, reconstituted leather.

Measures may vary slightly. We reserve the right to make changes without prior consultation.

Acabados de la tapa:

Laminado, laminado especial y laminado lacado, laca, vidrio pintado/escarchado, espejo, mármol y mármol alisado.

Acabados de las bases:

Laminado, laminado especial y laminado lacado, laca, cuero reconstituido.

Las medidas pueden variar un poco. Nos reservamos el derecho de realizar cambios sin previa consulta.



Paris 2D



MESAS DE CABECEIRA
BEDSIDE TABLES | MESAS DE CABECEIRA

pontovírgula



Paris 2D

MESAS DE CABECEIRA
BEDSIDE TABLES | MESAS DE CABECEIRA



Paris 2D

MESAS DE CABECEIRA
BEDSIDE TABLES | MESAS DE CABECEIRA

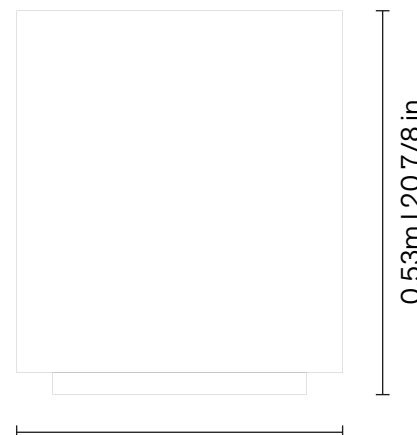
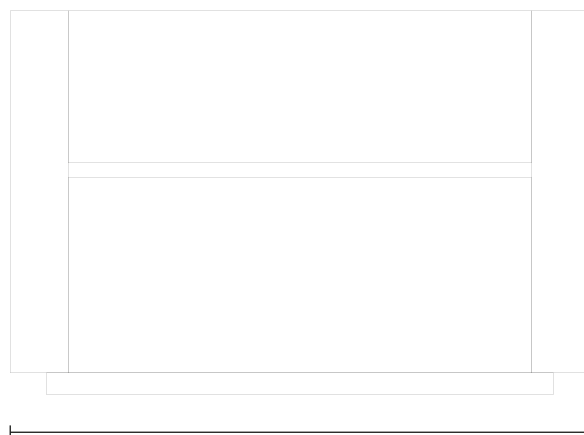
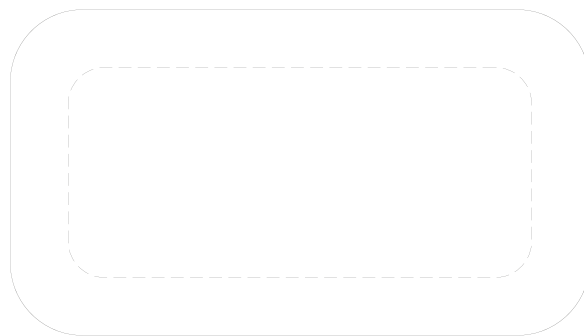

0,50m | 19 5/8 in
0,60m | 23 5/8 in
0,70m | 27 4/8 in
0,80m | 31 4/8 in
0,90m | 35 3/8 in
1,00m | 39 3/8 in

0,45m | 17 6/8 in

0,53m | 20 7/8 in



Paris 2D

MESAS DE CABECEIRA
BEDSIDE TABLES | MESAS DE CABECEIRA

DESIGN PADRÃO

STANDARD DESIGN | DISEÑO ESTÁNDAR

BORDAS DE PEDRA

STONE BORDERS | BORDES DE PIEDRA



RETO
STRAIGHT
RETO

Acabamentos do tampo:

Laminado, laminado especial e laminado laqueado, laca, vidro pintado/fosco, espelho, mármore e mármore levigado.

Acabamentos da base:

Laminado, laminado especial e laminado laqueado, laca.

Top finishes:

Laminate, special laminate and lacquered laminate, lacquer, painted/frosted glass, mirror, marble and honed marble.

Bases finishes:

Laminate, special laminate and lacquered laminate, lacquer.

Measures may vary slightly. We reserve the right to make changes without prior consultation.

Medidas podem apresentar leves variações. Nos reservamos o direito de efetuar alterações sem consulta prévia.

Acabados de la tapa:

Laminado, laminado especial y laminado lacado, laca, vidrio pintado/escarchado, espejo, mármol y mármol alisado.

Acabados de las bases:

Laminado, laminado especial y laminado lacado, laca.

Las medidas pueden variar un poco. Nos reservamos el derecho de realizar cambios sin previa consulta.



ponto**vírgula**

Paris 3D



MESAS DE CABECEIRA
BEDSIDE TABLES | MESAS DE CABECEIRA

pontovírgula



Paris 3D

MESAS DE CABECEIRA
BEDSIDE TABLES | MESAS DE CABECEIRA

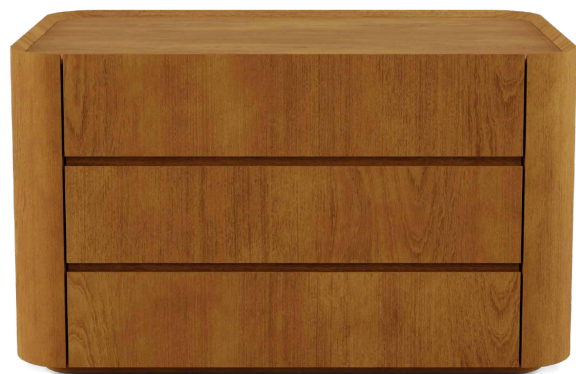

Paris 3D

MESAS DE CABECEIRA
BEDSIDE TABLES | MESAS DE CABECEIRA

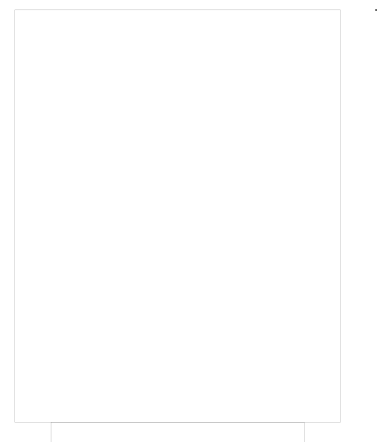
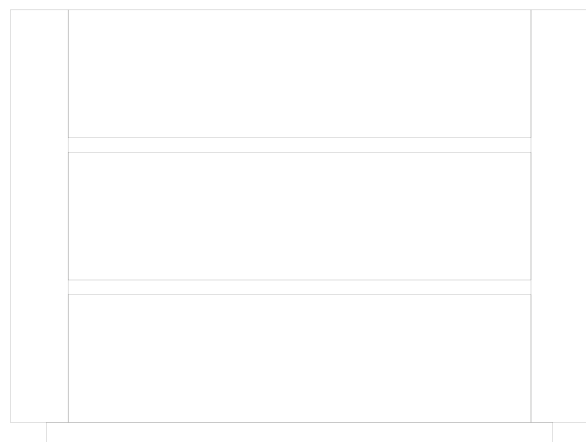
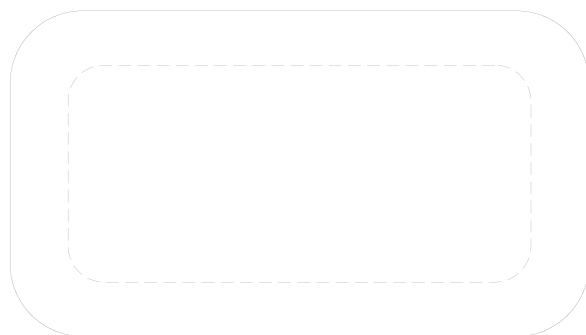

0,60m | 23 5/8 in
0,70m | 27 4/8 in
0,80m | 31 4/8 in
0,90m | 35 3/8 in
1,00m | 39 3/8 in



0,45m | 17 6/8 in



0,60m | 23 5/8 in



Paris 3D

MESAS DE CABECEIRA
BEDSIDE TABLES | MESAS DE CABECEIRA

DESIGN PADRÃO

STANDARD DESIGN | DISEÑO ESTÁNDAR

BORDAS DE PEDRA

STONE BORDERS | BORDES DE PIEDRA



RETO
STRAIGHT
RETO

Acabamentos do tampo:

Laminado, laminado especial e laminado laqueado, laca, vidro pintado/fosco, espelho, mármore e mármore levigado.

Acabamentos da base:

Laminado, laminado especial e laminado laqueado, laca.

Top finishes:

Laminate, special laminate and lacquered laminate, lacquer, painted/frosted glass, mirror, marble and honed marble.

Bases finishes:

Laminate, special laminate and lacquered laminate, lacquer.

Measures may vary slightly. We reserve the right to make changes without prior consultation.

Acabados de la tapa:

Laminado, laminado especial y laminado lacado, laca, vidrio pintado/escarchado, espejo, mármol y mármol alisado.

Acabados de las bases:

Laminado, laminado especial y laminado lacado, laca.

Las medidas pueden variar un poco. Nos reservamos el derecho de realizar cambios sin previa consulta.



MESAS DE JANTAR

DINING TABLES | MESAS DE COMEDOR

ponto**vírgula**

Arcadia



MESAS
TABLES | MESAS

pontovírgula



Arcadia

MESAS
TABLES | MESAS



Arcadia

MESAS
TABLES | MESAS

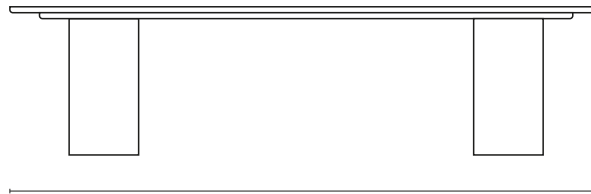
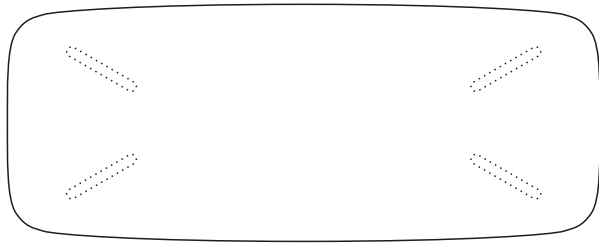

1,80 m | 70 7/8 in
2,00 m | 78 6/8 in
2,20 m | 86 5/8 in
2,40 m | 94 4/8 in
2,70 m | 106 2/8 in
3,00 m | 118 1/8 in

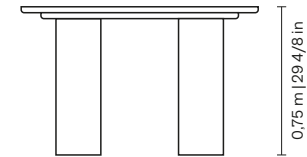

1,20 m | 47 2/8 in

0,75 m | 29 4/8 in

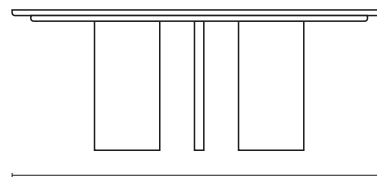
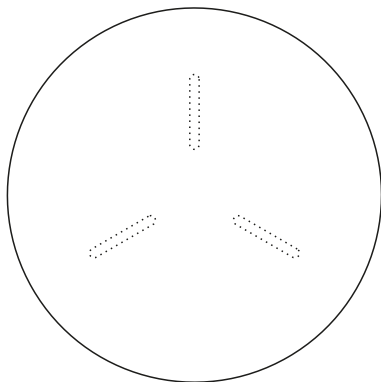

1,50 m | 59 in
1,60 m | 63 in
1,80 m | 70 7/8 in
2,00 m | 78 6/8 in
2,20 m | 86 5/8 in

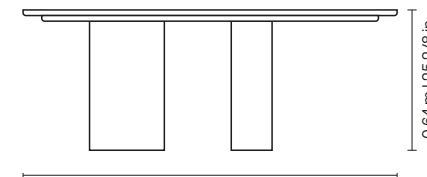

1,50 m | 59 in
1,60 m | 63 in
1,80 m | 70 7/8 in
2,00 m | 78 6/8 in
2,20 m | 86 5/8 in

0,64 m | 25 2/8 in



Arcadia

MESAS
TABLES | MESAS

DESIGN PADRÃO

STANDARD DESIGN | DISEÑO ESTÁNDAR

FORMATO DO TAMPO TOP SHAPES | FORMAS SUPERIORES



BARRIL
BARREL
BARRIL



REDONDO
ROUND
REDONDO

BORDAS INFERIORES UNDERTOP BORDERS | BORDES INFERIORES



SMOOTH R30*

BORDAS DE PEDRA STONE BORDERS | BORDES DE PIEDRA



FULL BULLNOSE

Acabamentos do tampo:
Laminado, laminado especial e laminado laqueado,
laca, vidro pintado/fosco, espelho, mármore e mármore levigado.

Acabamentos da base:
Laminado, laminado especial e laminado laqueado,
laca, couro.

Medidas podem apresentar leves variações. Nos reservamos o direito de efetuar alterações sem consulta prévia.

Top finishes:
Laminate, special laminate and lacquered laminate,
lacquer, painted/frosted glass, mirror, marble and honed marble.

Bases finishes:
Laminate, special laminate and lacquered laminate,
lacquer, reconstituted leather.

Measures may vary slightly. We reserve the right to make changes without prior consultation.

Acabados de la tapa:
Laminado, laminado especial y laminado lacado, laca,
vidrio pintado/escarchado, espejo, mármol y mármol alisado.

Acabados de las bases:
Laminado, laminado especial y lacquered laminate,
laca, cuero reconstituido.

Las medidas pueden variar un poco. Nos reservamos el derecho de realizar cambios sin previa consulta.



pontovírgula

Aurora



MESAS
TABLES | MESAS

pontovírgula



Aurora

MESAS
TABLES | MESAS



pontovírgula

Aurora

MESAS
TABLES | MESAS

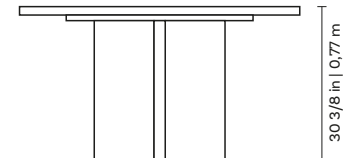
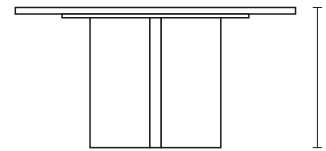
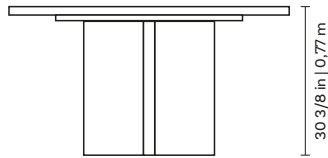
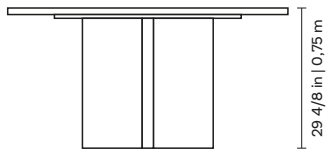
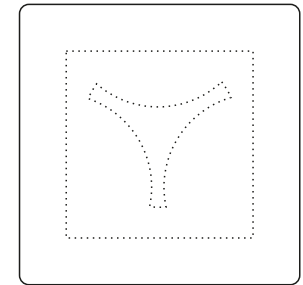
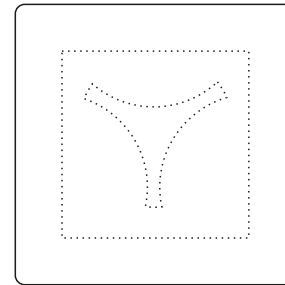
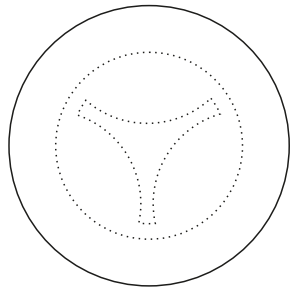
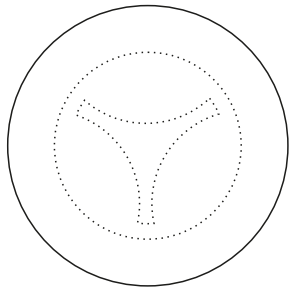

59 in | 1,50 m
63 in | 1,60 m
70 7/8 in | 1,80 m
78 6/8 in | 2,00 m

59 in | 1,50 m
63 in | 1,60 m
70 7/8 in | 1,80 m
78 6/8 in | 2,00 m

59 in | 1,50 m
63 in | 1,60 m
70 7/8 in | 1,80 m
78 6/8 in | 2,00 m

59 in | 1,50 m
63 in | 1,60 m
70 7/8 in | 1,80 m
78 6/8 in | 2,00 m



Aurora

MESAS
TABLES | MESAS

DESIGN PADRÃO

STANDARD DESIGN | DISEÑO ESTÁNDAR

FORMATO DO TAMPO

TOP SHAPES | FORMAS SUPERIORES



QUADRADO
SQUARE
CUADRADO



REDONDO
ROUND
REDONDO

BORDAS INFERIORES

UNDERTOP BORDERS | BORDES INFERIORES



RETO - EM METAL
STRAIGHT - IN METAL
RETO - EN METAL

BORDAS DE PEDRA

STONE BORDERS | BORDES DE PIEDRA



RETO
STRAIGHT
RETO

Acabamentos do tampo:

Laminado, laminado especial e laminado laqueado,
laca, vidro pintado/fosco, espelho, mármore e mármore levigado.

Acabamentos da base:

Laminado, laminado especial e laminado laqueado,
laca, couro.

Medidas podem apresentar leves variações. Nos reservamos o direito de efetuar alterações sem consulta prévia.

Top finishes:

Laminate, special laminate and lacquered laminate,
lacquer, painted/frosted glass, mirror, marble and honed marble.

Bases finishes:

Laminate, special laminate and lacquered laminate,
lacquer, reconstituted leather.

Measures may vary slightly. We reserve the right to make changes without prior consultation.

Acabados de la tapa:

Laminado, laminado especial y laminado lacado, laca,
vidrio pintado/escarchado, espejo, mármol y mármol alisado.

Acabados de las bases:

Laminate, special laminate and lacquered laminate,
laca, cuero reconstituido.

Las medidas pueden variar un poco. Nos reservamos el derecho de realizar cambios sin previa consulta.



ponto**vírgula**

Evie



MESAS
TABLES | MESAS

pontovírgula



Evie

MESAS
TABLES | MESAS



pontovírgula

Evie

MESAS
TABLES | MESAS

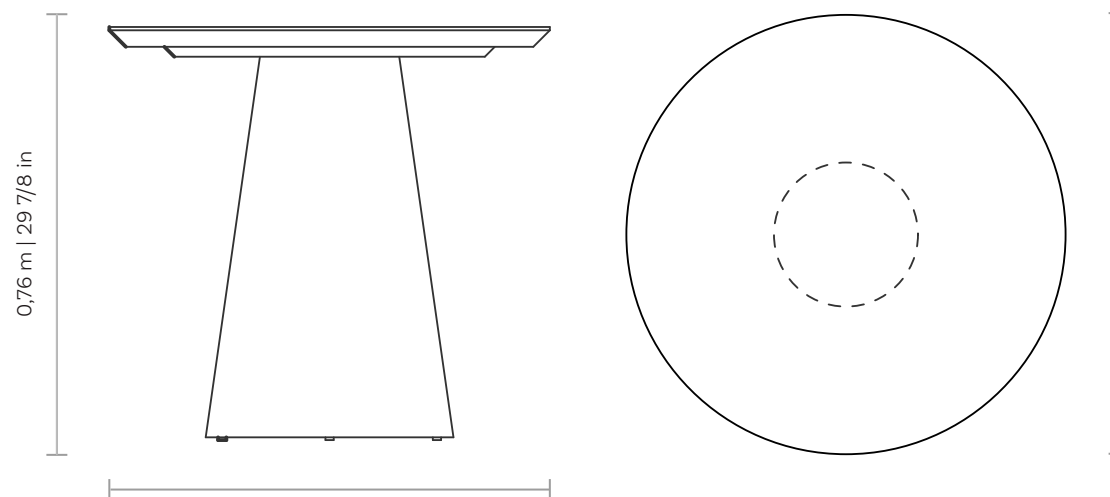

dimensões

0,90 x 0,90 m | 35 3/8 x 35 3/8 in
1,00 x 1,00 m | 39 3/8 x 39 3/8 in
1,20 x 1,20 m | 47 2/8 x 47 2/8 in
1,30 x 1,30 m | 51 1/8 x 51 1/8 in
1,50 x 1,50 m | 59 x 59 in
1,60 x 1,60 m | 63 x 63 in
1,80 x 1,80 m | 70 7/8 x 70 7/8 in



Evie

MESAS
TABLES | MESAS

Base: em MDF disponível nos acabamentos laminado, laminado especial, pintura laqueado e pintura laqueado metalizada.

Tampo: com opção em mármore ou MDF disponível no acabamento laminado, laminado especial, laqueado, laqueado metalizado, vidro ou vidro extraclear.

Medidas podem apresentar leves variações. Nos reservamos o direito de efetuar alterações sem consulta prévia.

Base: MDF available in laminated, special laminated, lacquer and metallic lacquer finishes.

Top: option in marble or MDF available in laminated, special laminated, lacquer, metallic lacquer finishes, glass or extraclear glass.

Measures may vary slightly. We reserve the right to make changes without prior consultation.

*For more information, see our Comfort Guide.

Base: en MDF disponible en acabados laminado, laminado especial, pintura lacada y pintura lacada metalizada.

Tablero: con opción en mármol o MDF disponible en laminado, laminado especial, lacado, lacado metalizado, vidrio o vidrio extraclaro.

Las medidas pueden variar un poco. Nos reservamos el derecho de realizar cambios sin previa consulta.

*Para más informaciones, consulte nuestro Guía de Confort.



Kovak



MESAS
TABLES | MESAS

pontovírgula



Kovak

MESAS
TABLES | MESAS



Kovak

MESAS
TABLES | MESAS

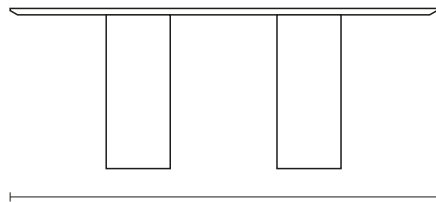
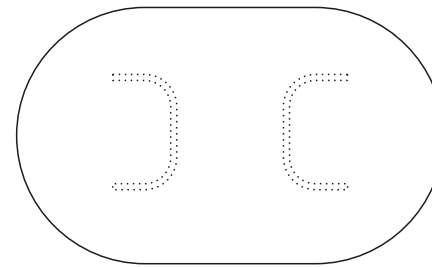
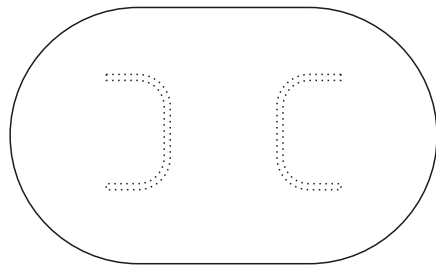

78 6/8 in | 2,00 m
86 5/8 in | 2,20 m
94 4/8 in | 2,40 m
106 2/8 in | 2,70 m
118 1/8 in | 3,00 m

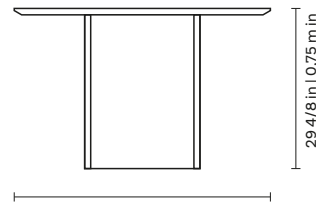

47 2/8 in | 1,20 m

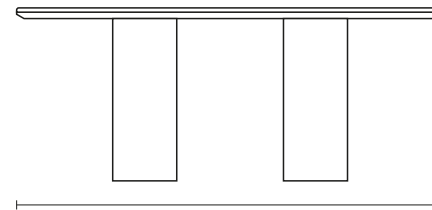

2,00 m | 78 6/8 in
2,20 m | 86 5/8 in
2,40 m | 94 4/8 in
2,70 m | 106 2/8 in
3,00 m | 118 1/8 in

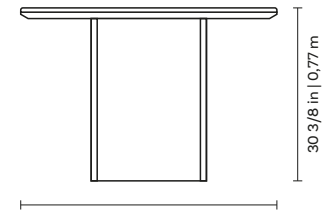

47 2/8 in | 1,20 m



DESIGN PADRÃO

STANDARD DESIGN | DISEÑO ESTÁNDAR

FORMATO DO TAMPO

TOP SHAPES | FORMAS SUPERIORES

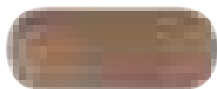

OBLONGO
OBLONG
OBLONGO

BORDAS INFERIORES

UNDERTOP BORDERS | BORDES INFERIORES



CHANFRO 60°
CHAMFER 60°
CHAFLAN 60°

BORDAS DE PEDRA

STONE BORDERS | BORDES DE PIEDRA



DEMI BULLNOSE

Acabamentos do tampo:

Laminado, laminado especial e laminado laqueado, laca, vidro pintado/fosco, espelho, mármore e mármore levigado.

Acabamentos da base:

Laminado, laminado especial e laminado laqueado, laca, recouro.

Top finishes:

Laminate, special laminate and lacquered laminate, lacquer, painted/frosted glass, mirror, marble and honed marble.

Bases finishes:

Laminate, special laminate and lacquered laminate lacquer, reconstituted leather.

Measures may vary slightly. We reserve the right to make changes without prior consultation.

Acabados de la tapa:

Laminado, laminado especial y laminado lacado, laca, vidrio pintado/escarchado, espejo, mármol y mármol alisado.

Acabados de las bases:

Laminado, laminado especial y laminado lacado, laca, cuero reconstituido.

Las medidas pueden variar un poco. Nos reservamos el derecho de realizar cambios sin previa consulta.



Vienna



MESAS
TABLES | MESAS

pontovírgula



Vienna

MESAS
TABLES | MESAS

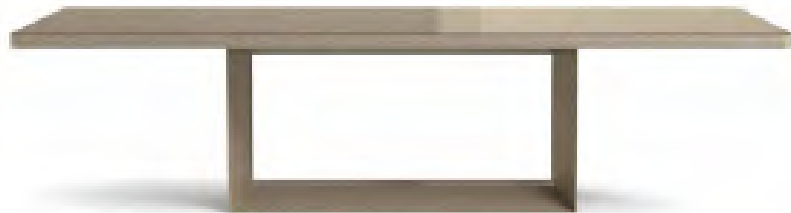

Vienna

MESAS
TABLES | MESAS

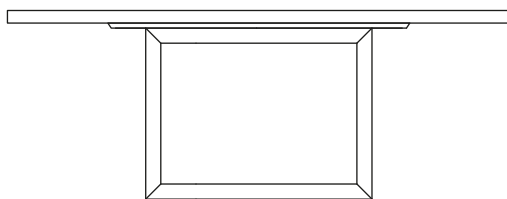
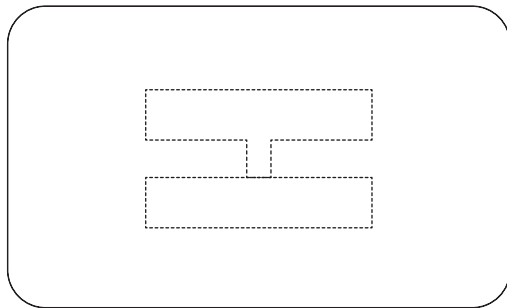

86 5/8 in | 2,20 m
94 4/8 in | 2,40 m
106 2/8 in | 2,70 m

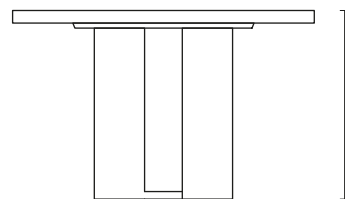

47 2/8 in | 1,20 m

29 4/8 in | 0,75 m

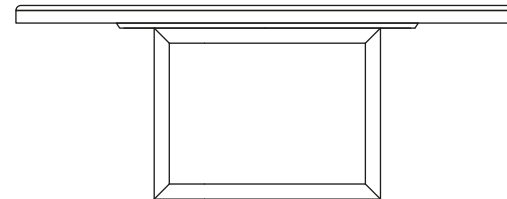
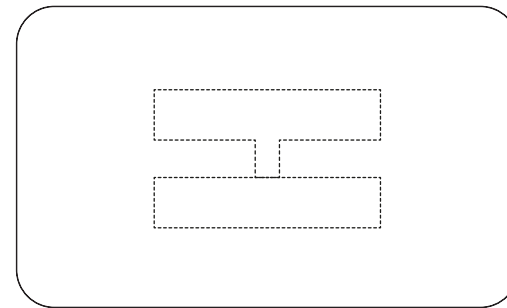

86 5/8 in | 2,20 m
94 4/8 in | 2,40 m
106 2/8 in | 2,70 m

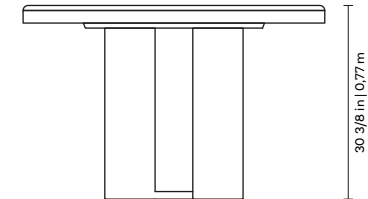

47 2/8 in | 1,20 m

30 3/8 in | 0,77 m



Vienna

MESAS
TABLES | MESAS

DESIGN PADRÃO

STANDARD DESIGN | DISEÑO ESTÁNDAR

FORMATO DO TAMPO

TOP SHAPES | FORMAS SUPERIORES



RETÂNGULAR 150MM
RECTANGULAR 150 MM
RETANGULAR 150MM

BORDAS INFERIORES

UNDERTOP BORDERS | BORDES INFERIORES



RETO
STRAIGHT
RETO

BORDAS DE PEDRA

STONE BORDERS | BORDES DE PIEDRA



DEMI BULLNOSE



RETO
STRAIGHT
RETO

Acabamentos do tampo:

Laminado, laminado especial e laminado laqueado, laca, vidro pintado/fosco, espelho, mármore e mármore levigado.

Acabamentos da base:

Laminado, laminado especial e laminado laqueado, laca, recouro.

Top finishes:

Laminate, special laminate and lacquered laminate, lacquer, painted/frosted glass, mirror, marble and honed marble.

Bases finishes:

Laminate, special laminate and lacquered laminate lacquer, reconstituted leather.

Measures may vary slightly. We reserve the right to make changes without prior consultation.

Acabados de la tapa:

Laminado, laminado especial y laminado lacado, laca, vidrio pintado/escarchado, espejo, mármol y mármol alisado.

Acabados de las bases:

Laminado, laminado especial y laminado lacado, laca, cuero reconstituido.

Las medidas pueden variar un poco. Nos reservamos el derecho de realizar cambios sin previa consulta.



ponto**vírgula**

APARADORES E BUFFETS

CONSOLES AND BUFFETS | MESAS DE ARRIMO Y BUFFETS

ponto**vírgula**

Aeris



APARADORES E BUFFETS
CONSOLES AND BUFFETS | MESAS DE ARRIMO Y BUFFETS

pontovírgula



Aeris

APARADORES E BUFFETS
CONSOLES AND BUFFETS | MESAS DE ARRIMO Y BUFFETS

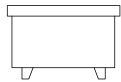

Aeris

APARADORES E BUFFETS
CONSOLES AND BUFFETS | MESAS DE ARRIMO Y BUFFETS

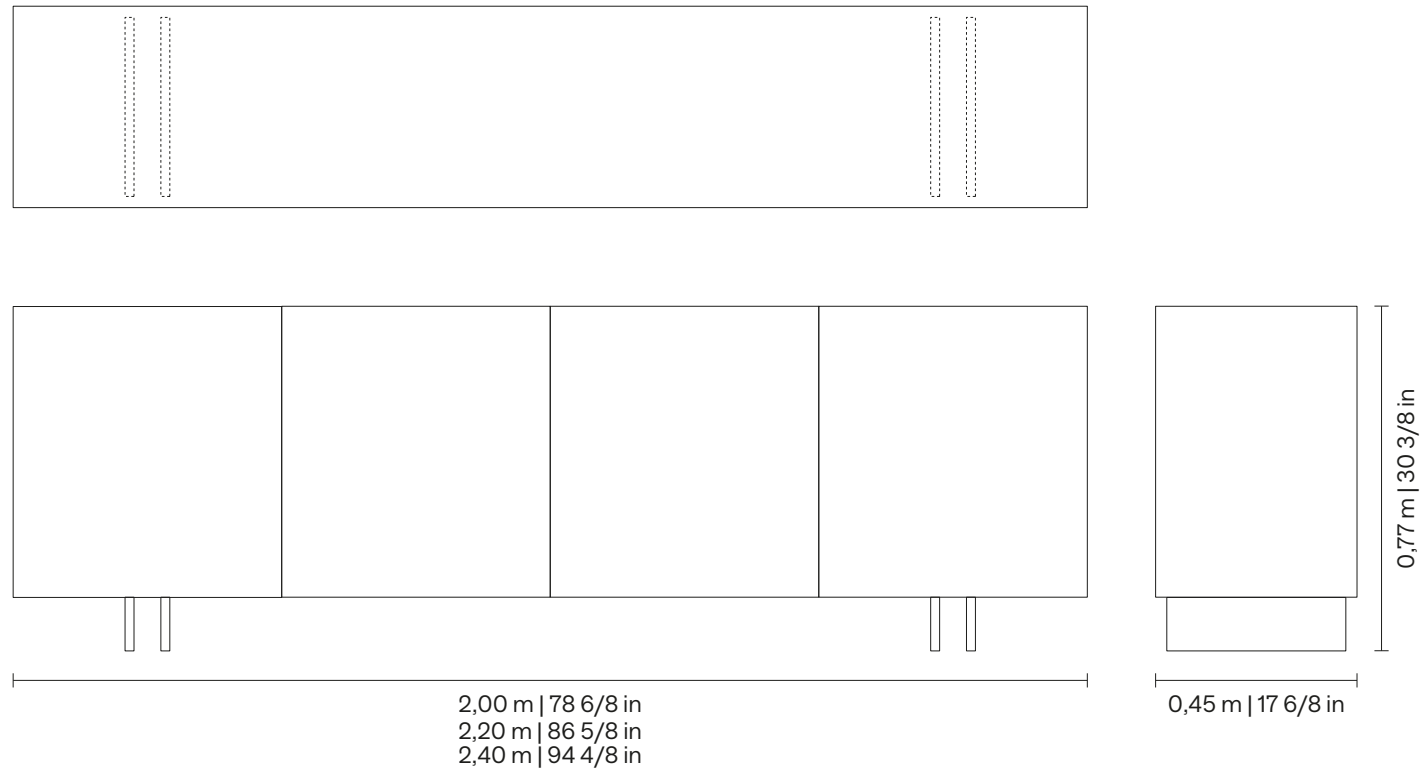

Aeris

APARADORES E BUFFETS
CONSOLES AND BUFFETS | MESAS DE ARRIMO Y BUFFETS

DESIGN PADRÃO

STANDARD DESIGN | DISEÑO ESTÁNDAR

Apenas em tamanhos padrão.

A porta pode ser finalizada em couro, laminado, vidro pintado, espelho e laca.

Only on Standard Sizes.

The door can be finished in leather, laminate, painted glass, mirror and lacquere laca.

Solo en tamaños estándar.

La puerta puede acabarse en cuero, laminado, vidrio pintado, espejo y laca.

Acabamentos do tampo:

Laminado, laminado especial e laminado laqueado, laca, vidro pintado/fosco, espelho.

Acabamentos da base:

Laminado, laminado especial e laminado laqueado, laca, recouro.

Medidas podem apresentar leves variações. Nos reservamos o direito de efetuar alterações sem consulta prévia.

Top finishes:

Laminate, special laminate and lacquered laminate, lacquer, painted/frosted glass, mirror.

Bases finishes:

Laminate, special laminate and lacquered laminate, lacquer, reconstituted leather.

Measures may vary slightly. We reserve the right to make changes without prior consultation.

Acabados de la tapa:

Laminado, laminado especial y laminado lacado, laca, vidrio pintado/escarchado, espejo.

Acabados de las bases:

Laminado, laminado especial y laminado lacado, laca, cuero reconstituido.

Las medidas pueden variar un poco. Nos reservamos el derecho de realizar cambios sin previa consulta.



Bridge



APARADORES E BUFFETS
CONSOLES AND BUFFETS | MESAS DE ARRIMO Y BUFFETS

pontovírgula



Bridge

APARADORES E BUFFETS
CONSOLES AND BUFFETS | MESAS DE ARRIMO Y BUFFETS

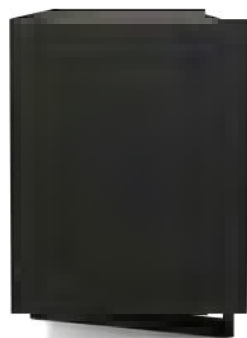

Bridge

APARADORES E BUFFETS
CONSOLES AND BUFFETS | MESAS DE ARRIMO Y BUFFETS

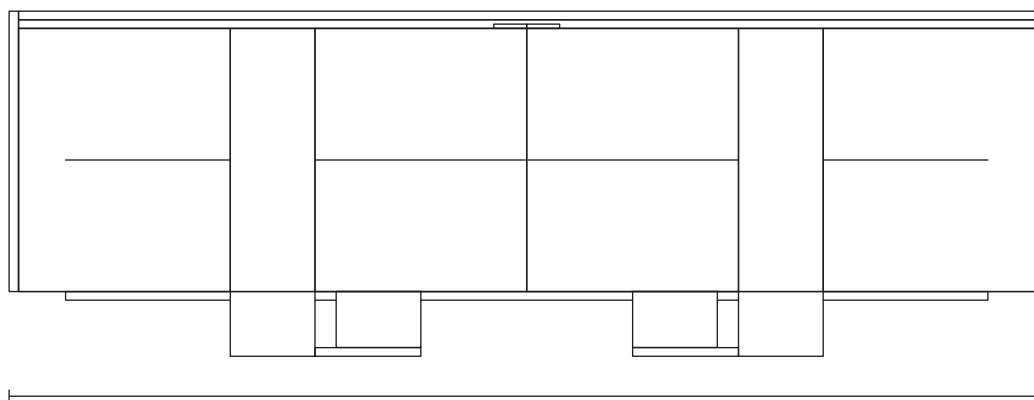
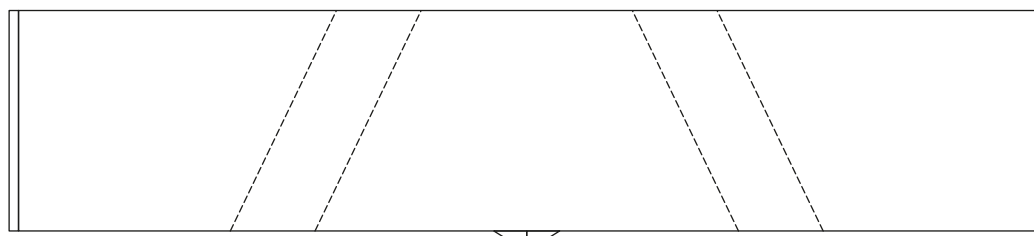

2,00 m | 78 6/8 in
2,20 m | 86 5/8 in
2,40 m | 94 4/8 in

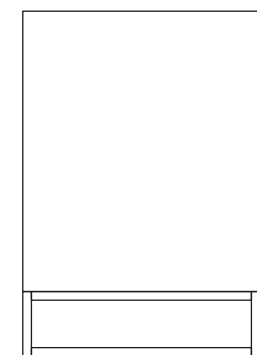

0,80 m | 31 4/8 in



0,55 m | 21 5/8 in



Bridge

DESIGN PADRÃO

STANDARD DESIGN | DISEÑO ESTÁNDAR

BORDAS DE PEDRA

STONE BORDERS | BORDES DE PIEDRA



CHANFRO 60°
CHAMFER 60°
CHAFLÁN 60°

Acabamentos do tampo:

Laminado, laminado especial e laminado laqueado, laca, vidro pintado/fosco, espelho, mármore e mármore levigado.

Acabamentos da base:

Laminado, laminado especial e laminado laqueado, laca, recouro.

Medidas podem apresentar leves variações. Nos reservamos o direito de efetuar alterações sem consulta prévia.

APARADORES E BUFFETS CONSOLES AND BUFFETS | MESAS DE ARRIMO Y BUFFETS

Top finishes:

Laminate, special laminate and lacquered laminate, lacquer, painted/frosted glass, mirror, marble and honed marble.

Bases finishes:

Laminate, special laminate and lacquered laminate, lacquer, reconstituted leather.

Measures may vary slightly. We reserve the right to make changes without prior consultation.

Acabados de la tapa:

Laminado, laminado especial y laminado lacado, laca, vidrio pintado/escarchado, espejo, mármol y mármol alisado.

Acabados de las bases:

Laminado, laminado especial y laminado lacado, laca, cuero reconstituido.

Las medidas pueden variar un poco. Nos reservamos el derecho de realizar cambios sin previa consulta.



CAMAS

BEDS | CAMAS

ponto**virgula**

Grace



CAMAS
BEDS | CAMAS

ponto**vírgula**



Grace

CAMAS
BEDS | CAMAS



Grace

CAMAS
BEDS | CAMAS

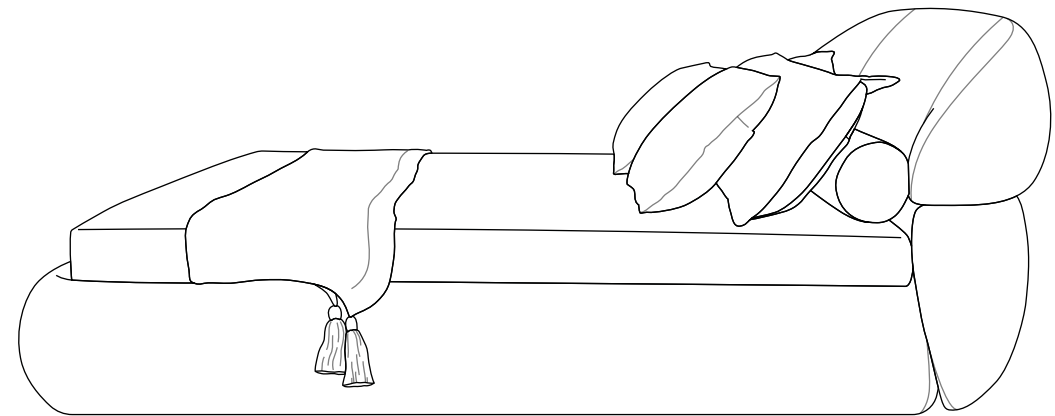
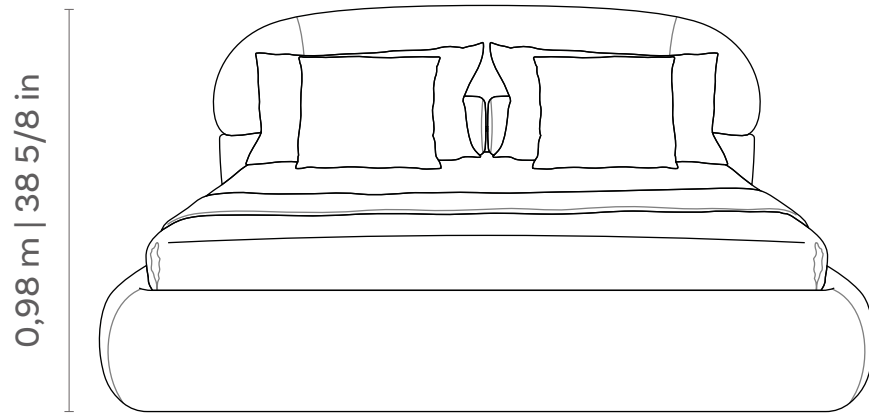

2,40 | 2,50 | 2,55 m
94 4/8 | 98 3/8 | 100 3/8 in



pontovirgula

Grace

CAMAS
BEDS | CAMAS

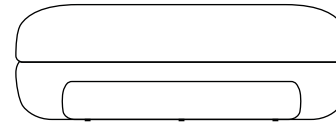
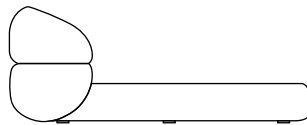
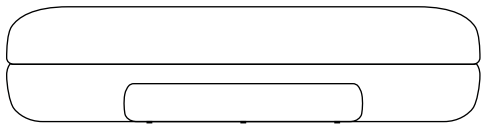
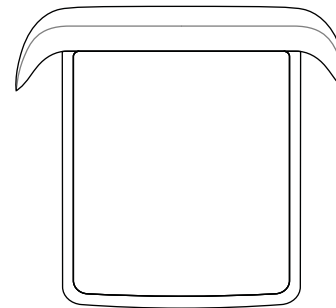
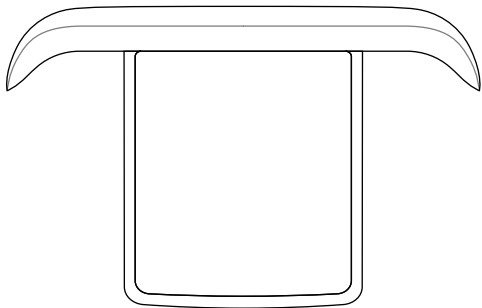

3,45 | 3,65 | 4,00 m
135 7/8 | 143 6/8 | 157 4/8 in

2,40 | 2,50 | 2,55 m
94 4/8 | 98 3/8 | 100 3/8 in

2,25 | 2,45 | 2,80 m
135 7/8 | 143 6/8 | 157 4/8 in

2,25 | 2,45 | 2,80 m
88 5/8 | 96 4/8 | 110 2/8 in



pontovirgula

Grace

CAMAS
BEDS | CAMAS

Cabeceira e estrado tapeçados, com estrutura interna em madeira. Almofadas de apoio soltas. Almofadas rolinho. Pés em plástico injetado preto. Medidas especiais disponíveis sob consulta. Colchão não acompanha a cama.

Medidas podem apresentar leves variações. Nos reservamos o direito de efetuar alterações sem consulta prévia.

Tapered headboard and bed base, with internal wooden structure. Loose backing cushions. Roll cushions. Black injected plastic feet. Custom sizes available, upon request. Mattress does not accompany the bed.

Measures may vary slightly. We reserve the right to make changes without prior consultation.

Cabecero y somier tapeçados, con estructura interna de madera. Conjín de respaldo sueltas. Cojín de rollo. Patas de plástico inyectado de color negro. Tamaños personalizables disponibles, bajo consulta. El colchón no acompaña a la cama.

Las medidas pueden variar un poco. Nos reservamos el derecho de realizar cambios sin previa consulta.



ESPELHOS

MIRRORS | ESPEJOS

ponto**vírgula**

Amarna



ESPELHOS
MIRRORS | ESPEJOS

pontovírgula



Amarna

ESPELHOS
MIRRORS | ESPEJOS



Amarna

ESPELHOS
MIRRORS | ESPEJOS

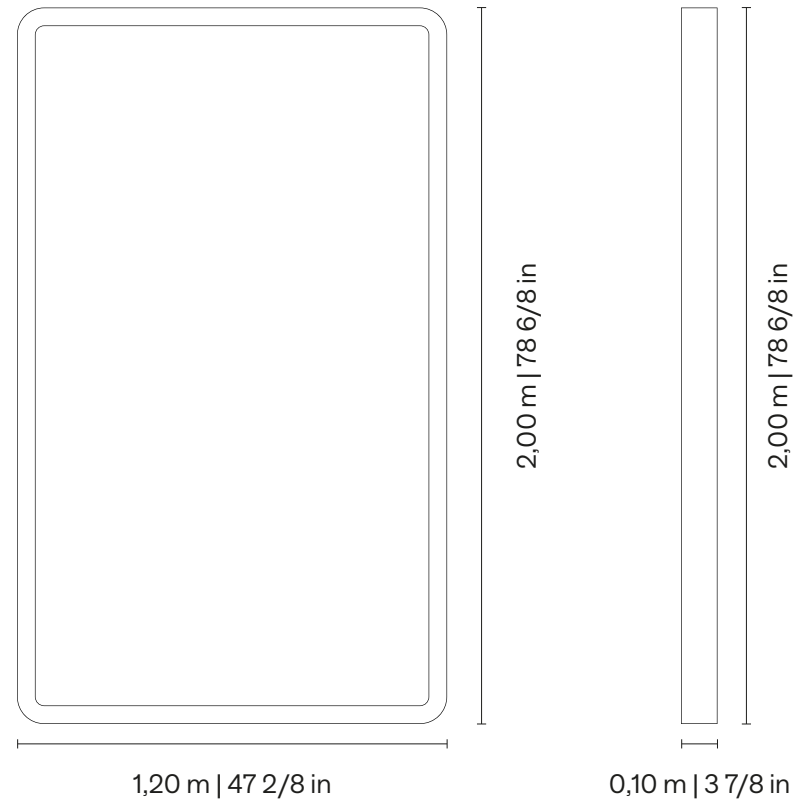

Amarna

ESPELHOS
MIRRORS | ESPEJOS

Acabamentos da base:
Laminado, laminado especial e
laminado laqueado, laca.

Medidas podem apresentar leves variações. Nos reservamos o direito de efetuar alterações sem consulta prévia.

Bases finishes:
Laminate, special laminate and
lacquered laminate, lacquer.

Measures may vary slightly. We reserve the right to make changes without prior consultation.

Acabados de las bases:
Laminado, laminado especial y
laminado lacado, laca.

Las medidas pueden variar un poco. Nos reservamos el derecho de realizar cambios sin previa consulta.



Voltige



ESPELHOS
MIRRORS | ESPEJOS

ponto**vírgula**



Voltige

ESPELHOS
MIRRORS | ESPEJOS



Voltige

ESPELHOS
MIRRORS | ESPEJOS

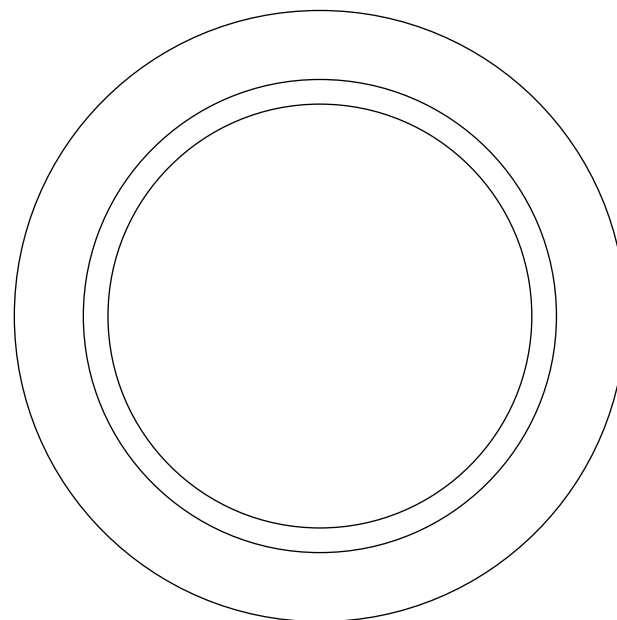

1,10 m | 43 2/8 in
1,55 m | 61 in

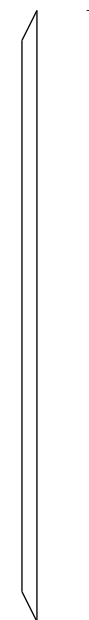

1,10 m | 43 2/8 in
1,55 m | 61 in



0,38 m | 15 in



Voltige

ESPELHOS
MIRRORS | ESPEJOS

Acabamentos da base:
Laminado, laminado especial e
laminado laqueado, laca.

Medidas podem apresentar leves variações. Nos reservamos o direito de efetuar alterações sem consulta prévia.

Bases finishes:
Laminate, special laminate and
lacquered laminate, lacquer.

Measures may vary slightly. We reserve the right to make changes without prior consultation.

Acabados de las bases:
Laminado, laminado especial y
laminado lacado, laca.

Las medidas pueden variar un poco. Nos reservamos el derecho de realizar cambios sin previa consulta.



pontovírgula

pontovirgula.com | [@pontovirgula](https://twitter.com/pontovirgula)